

SCHEDULE
(Regulation 3)

**NATIONAL BUILDING
CODE**

FIJI ISLANDS

778

344

[LEGAL NOTICE No. 107]

**PUBLIC HEALTH ACT
(CAP. 111)**

**PUBLIC HEALTH (NATIONAL BUILDING CODE)
REGULATIONS 2004**

IN exercise of the powers conferred upon it by Section 39 and with the approval of the Minister, the Board makes these Regulations—

Citation

1. These regulations may be cited as the Public Health (National Building Code) Regulations 2004.

Application

2. These Regulations apply to the whole of the Fiji Islands.

National Building Code

3.—(1) The National Building Code set out in the Schedule shall be used for construction of all buildings to which the Act applies, for all classes of occupancy.

(2) If a regulation or by-law made under the Act or under any other written law before or after the commencement of these regulations is inconsistent with any requirement under the National Building Code, the requirement in the Code prevails.

Breach of Code

4. A person who fails to comply with a requirement of the Code commits an offence and is liable on conviction to a fine not exceeding \$200 and if the non-compliance continues, to a further fine not exceeding \$4 a day for each day during which the non-compliance continues after the conviction.

Dated at Suva this 27th day of October 2004.

S. NAIVALU
Minister for Health

CONTENTS

PREFACE

ACKNOWLEDGEMENT

INTRODUCTION

A GENERAL PROVISIONS

- A1 Interpretation
- A2 Acceptance of Design and Construction
- A3 Classification of Buildings and Structures
- A4 United Buildings

B STRUCTURE

Performance Requirements Deemed-to-Satisfy Provisions

- B1 Structural Provisions
- B2 Demolition

DWELLINGS AND OUTBUILDINGS

DC FIRE RESISTANCE

Performance Requirements Deemed-to-Satisfy Provisions

- DC1 Fire Resistance and Stability

DD ACCESS AND EGRESS

Performance Requirements Deemed-to-Satisfy Provisions

- DD1 Construction of Exits

DE ELECTRICITY

Performance Requirements Deemed-to-Satisfy Provisions

- DE1 Electrical Safety
- DE2 Amenity

DF HEALTH AND AMENITY

Performance Requirements Deemed-to-Satisfy Provisions

- DF1 Damp and Weatherproofing
- DF2 Cooking and Sanitary Facilities
- DF3 Room Sizes and Heights
- DF4 Light and Ventilation
- DF5 Watersupply Plumbing
- DF6 Sanitary Plumbing and Drainage
- DF7 Roof Drainage

DG ANCILLARY PROVISIONS

Performance Requirements Deemed-to-Satisfy Provisions

- DG1 Minor Structures and Components
- DG2 Fireplaces, Chimneys and Flues

PUBLIC BUILDINGS AND GROUP DWELLINGS

NC FIRE RESISTANCE

Performance Requirements Deemed-to-Satisfy Provisions

- NC1 - Fire Resistance and Stability
- NC2 - Compartmentation and Separation
- NC3 - Protection of Openings

ND ACCESS AND EGRESS

Performance Requirements Deemed-to-Satisfy Provisions

- ND1 Provision for Escape
- ND2 Construction of Exits
- ND3 Access for People with Disabilities

NE SERVICES AND EQUIPMENT

Performance Requirements Deemed-to-Satisfy Provisions

- NE1 Fire Fighting Equipment
- NE2 Mechanical Ventilation
- NE3 Lift Installations
- NE4 Emergency Lighting and Exit Signs
- NE5 Maintenance of Safety Installations
- NE6 Electricity

NF HEALTH AND AMENITY

Performance Requirements Deemed-to-Satisfy Provisions

- NF1 Damp and Weatherproofing
- NF2 Sanitary Facilities
- NF3 Room Sizes
- NF4 Light and Ventilation
- NF5 Watersupply Plumbing
- NF6 Sanitary Plumbing and Drainage
- NF7 Roof Drainage

NG ANCILLARY PROVISIONS

Performance Requirements Deemed-to-Satisfy Provisions

- NG1 Minor Structures and Components
- NG2 Fireplaces, Chimneys and Flues
- NG3 Atrium Construction

NH SPECIAL USE BUILDINGS

Performance Requirements Deemed-to-Satisfy Provisions

- NH1 Theatres, Stages and Public Halls

PREFACE

The work on the National Building Code was begun in response to the disastrous cyclones which hit Fiji in 1983 and 1985. The cyclones of 1983 aroused widespread community concern which led to the formation of the Fiji Building Standards Committee. The aim of the Committee was to formulate practical measures to combat cyclones and thus to significantly reduce repeated suffering and destruction. The work on the Code has been the main focus of the Committee.

The membership of the Committee and the financial support it has received bear ample testimony to the public support it has had in its work. The members represented a wide range of interests and all of them worked on a voluntary basis. Builders, Architects, Engineers, the Fire Service, Insurers and Brokers, Banks and Financing Institutions, Technical Educational Institutions, the Central and Local Government Departments, the Consumer Council, and the Housing Authority were all among the organisations which had representatives working on the Committee.

The Government of Fiji has given substantial financial support to the Committee. The Underwriters Association of Fiji, which initially campaigned for the reform of building standards, prudently kept itself at a distance from the technical work of the Committee and helped it with financial support. Builders, hardware merchants and several others have made financial contributions.

On the request of the Government of Fiji, the Australian Government has helped the Committee with the administration and funding of the detailed technical work on the Code. The Project office which was established for this purpose has worked closely with the Committee on a participatory basis. Beginning with a draft based on the Building Code of Australia several revised drafts of the Code were produced. Each successive draft gained significantly from the critical comments and suggestions from the members of the Committee and other interested individuals. Several overseas experts freely gave their time to help with crucial advice on specific aspects of the Code. Open public seminars were held to elicit a wide range of comments and opinions on the Code. Towards the end of its completion a few members of the Committee worked very closely with the Project staff to oversee the detailed final work and thus ensure that the Code would technically and economically be relevant for use in Fiji.

The actual use of the Code will in course of time reveal particular areas where it might need some modification. In fact it is only such periodic examination and suitable revision which will keep it up-to-date and relevant. In the meantime the Code is one of the very few documents of its type which has gone through the several levels of professional and public examination to test its relevance and usefulness. Therefore in a very real sense it is the National Building Code of Fiji.



Kris Ayyar
Project Manager
Pacific Building Standards Project

Suva August 1990

ACKNOWLEDGEMENT

A very large number of people and the organisations that they represent have contributed to the successful completion of the Code. It is not possible to acknowledge their help individually. Among those who were especially generous were:-

IN FIJI

Savenaca Siwatibau who had formed the Fiji Building Standards Committee (FBSC) to spearhead the reform of building standards in Fiji and who was its Chairman during the crucial initial period.

Clive Amputch who as the current Chairman of FBSC and as its past Secretary did a great deal of work in organising the progressive review and critical debate of the work on the Code by the members of the Committee. His staff guided by Kumendra Singh were always helpful.

Well known Architect Stuart Huggett and prominent Consulting Engineers Pat Maybin and Bill Yee, the three of whom exercised a healthy and restraining influence on the Code through the wisdom of their long years of work in Fiji.

All the volunteer members of the FBSC who patiently sat through several review meetings and made their contribution to improvement. The following members of the Committee went far beyond the call of ordinary social commitment and spent several long hours in critically examining practically every clause of the Code through its many revisions -

Anamul Haque	-	Senior Health Inspector, Ministry of Health
Dick Elder	-	General Manager, J.S.Hill & Associates
Dipak Solanki	-	City Engineer, Suva City Council
Isireli Gasenivalu	-	Deputy Chief Fire Officer, Suva Fire Brigade
Jamnadas Kevat	-	Principal Architect, Public Works Department
Suliasi Ratumaikoro	-	Fire Safety Officer, Suva Fire Brigade

Hamendra Lodhia, Consulting Engineer, played an active role in the initial stages when basic parameters for the work were determined.

Vilisoni Cagimaivai, Health Inspector and Building Surveyor, Ba Town, encouraged us with his enthusiasm and pioneering efforts at improving building control.

Kariwardan Naicker, Building Surveyor, Lautoka City, gave us information on drainage requirements.

Roderick Moody, Consulting Engineer, gave valuable help with his advice on building services.

Trevor Jones, Senior Seismologist of the Government of Fiji, was very helpful with his advice on the provision of different levels of earthquake risk. He also volunteered for the painstaking job of proof reading and did an excellent job.

Ram Krishna until recently Director, Rajendra Prasad current Director, and Sarojni Reddy Principal Scientific Officer, Fiji Meteorological Bureau helped with information on extreme winds and rainfall.

Stefan Ali of Datacom gave excellent support service to our computer system.

Davendra Rao, Education Officer (retired), performed the onerous task of proof reading.

Robert Austin, Printing and Design Consultant, gave us professional advice on the cover design and printing of the Code.

Shan Mohammed, of Shan & Associates, provided many of the drawings.

ACKNOWLEDGEMENT

IN AUSTRALIA

Robert Hogg, Director, Australian Uniform Building Regulations Co-ordinating Council and the members of its Executive Committee showed their great generosity in exempting us from the copyright requirements of the Building Code of Australia.

Dr George Walker, formerly Associate Professor of Civil Engineering at the James Cook University and currently Director National Building Technology Centre, Sydney, was of immense help.

Stewart Horwood, Chief Executive, Peter Walsh, Director Standards and other officers of the Standards Association of Australia were very helpful with the supply of Australian Standards and relevant explanations. I have reproduced five diagrams from Australian Standard AS 2180 in Specification NF7.2 of the Code.

Geoff Anderson, Associate Director, and Hugh Knox, Manager Regulations Accreditations and Standards of the National Building Technology Centre, helped with the supply of references and technical advice.

Lawrence Reddaway, Director Irwin Johnston & Partners Melbourne and Dr Vaughan Beck Principal Lecturer Footscray Institute of Technology, gave invaluable advice on fire engineering that gave me ideas for cost - reducing changes without any material reduction in life-safety.

Jane Blackmore, Consulting Engineer Sydney, made an overall review of the draft Code and gave her comments.

Paul Smith, Assistant Director, Leo Blumkle Manager Building Services and Ron de Veer, Referee of the Queensland Department of Local Government, helped with their comments and explanations of building control practices in Queensland.

IN NEW ZEALAND

John Hunt, Executive Director, and Boyd Dunlop, Executive Officer of the Building Industry Commission. They provided valuable advice and kept us informed of their work on the production of the New Zealand Building Code. I have borrowed ideas and concepts from their work and reproduced with suitable alterations two diagrams and their acceptable solution for stairways and ramps in the Code.

Russell Cooney, Manager Building Industry Development, and Andrew King, Leader Structural Engineering Group of the Building Research Association of New Zealand. Russell and Andrew gave willingly of their time and expertise especially in the area of designing against earthquake and safety against human impact of glass. They also supplied us with valuable reference documents.

Denys Pinfold and Denis Ferrier, the past and present Directors and other officers of the Standards Association of New Zealand, helped with the supply of New Zealand Standards and useful explanations.

John Fraser, Manager, Fire Protection Inspection Services Limited, Auckland, provided outstanding help with a review of the fire protection provisions of the Code and gave practical advice which allowed me to tailor the Code to the needs and available equipment in Fiji.

Clifford Barnett, Fire Engineer and Director of Macdonald Barnett Partners Limited, Auckland, and Denis Bastings, Director Fire Safety Advisers Limited, Wellington, gave their time and expertise in discussing the Code requirements.

Dr Steve Reid, helped us with the supply of processed meteorological data.

IN THE UNITED STATES OF AMERICA

James Bihl, President International Conference of Building Officials, supplied us with their Uniform Building Code and other related documents which were very useful references.

The Council of American Building Officials: I have reproduced four diagrams after suitable alterations from their publication One and Two Family Dwelling Code in Section DF of the Code.

Elliot Stephenson, Structural and Fire Protection Engineer, spent considerable time with me during his holiday in Fiji and gave valuable advice on the Code.

AUSTRALIAN INTERNATIONAL DEVELOPMENT ASSISTANCE BUREAU

Roger Dickson, Engineer with the Pacific Regional Team Sydney, was extremely helpful and acted as a bridge between me and the AIDAB administration.

Mark Latham and Graham Nicholls, past and present Development Aid Counsellors at the Australian Embassy, Suva have supported the work with all the resource at their command.

Cathy Bennett, Keith Joyce and Greg Brooke in Suva, and Arthur Burch, Lynn Pieper and Chris Wheeler in Canberra were all extremely helpful in sorting out the administrative tangles that enveloped the project from time to time. Keith and Greg in particular were associated with the project during its stormiest days and helped to steer it through the reef.

Last but not least were the team in the project office. No words can express my gratitude for their sincerity and dedication. Most directly associated with the specific work on the Code were Manju Gounder in the very early stages, Saras Prasad for the bulk of the time and Sashi Lata Pal all of the time. In particular I owe Sashi a great deal for her excellent contribution. Wati Ledua, Raveena Dutt and Michael Arun Shankar helped with the many administrative tasks in the office, in particular the production of hundreds of bound copies of the several draft documents. Rohit Singh, Deputy Project Manager and Hem Rao, Project Engineer, were my sounding board for testing the practicality of many of the Code provisions.

Kris Ayyar

INTRODUCTION

About this Code

The basic objective of the Code is to ensure that acceptable standards of structural sufficiency, fire safety, health and amenity, are maintained for the benefit of the community now and in the future.

The requirements included in this Code are intended to extend no further than is necessary in the public interest, to be cost effective, not needlessly onerous in their application, and easily understood.

What is in the Code?

The Code sets down the Performance Requirements and corresponding Deemed-to-Satisfy Provisions which apply to the construction of buildings for all classes of occupancy.

It must be recognised that a building code cannot cover every issue concerned with the design and construction of buildings. In the case of innovative, complex or unusually hazardous building proposals, or other building work beyond the scope of the Code, legislation may provide for other suitable action.

Where appropriate the Code allows for variations in climate and geological conditions.

The Code covers those aspects of buildings which are controlled by Approval Authorities such as structure, fire resistance, access and egress, fire-fighting equipment, mechanical ventilation, lift installations, and certain aspects of health and amenity.

Performance Requirements

These are described in terms which would allow considerable scope for innovation and the development of new materials and methods of construction. The Requirements are in some cases separated into objectives and the required performance.

Objectives are broad statements of intent and are included at the beginning of each Section to identify the objectives that the provisions of the Section are intended to achieve. They are the basic concepts which apply generally to all buildings and structures.

Required Performance gives the fundamental requirements which will satisfy the objectives and are expressed in performance terms. Accreditation certificates, test reports, detailed calculations or other documentary evidence may be used as evidence that a particular material, design or construction method meets the performance requirements of this Code.

Deemed-to-satisfy Provisions

The Deemed-to-Satisfy Provisions have been drafted in sufficiently general terms to allow some flexibility without increasing the need to use administrative discretion. In the absence of national Standards for design, construction and materials, the Standards produced by the Standards Association of Australia and New Zealand have been called up. Detailed specifications have been given where necessary.

Professional Certification

The Code allows for certificates from professional consultants to be used as evidence of compliance with particular requirements or standards.

The enabling legislation will determine the extent of the use of professional certification and the procedures for the submission of certificates, reports or other documentation to Approval Authorities as evidence of compliance.

Layout of the Code

The numbering of Sections and Parts has been made on an alpha-numeric system for ease of reference. It provides flexibility to accommodate future additions or deletions and the future consolidation of building regulations presently contained in other legislation, without undue disruption to the layout.

Other than for common provisions contained in Sections A and B, the Code is divided into two areas - one which covers Class 1 and 10 buildings, and the other which covers all other Classes of buildings.

The pages containing the Performance Requirements are identified by the use of coloured paper. The Specifications relating to the Deemed-to-Satisfy Provisions have also been printed on coloured paper but with the edges screened.

Administrative Arrangements

This Code is brought into effect by enabling building control legislation which prescribes or "calls up" the technical requirements which have to be satisfied in order to gain approval.

The enabling legislation consists of an Act of Parliament and subordinate legislation. It empowers the Administration to regulate certain aspects of the building process and contains the necessary administrative provisions for the work of the Approval Authority. The legislation also imposes responsibilities on the authorities or other persons or bodies, and describes particular administrative procedures.

INTRODUCTION

The following administrative matters are covered in the enabling or subordinate legislation -

- Plan submission and approval procedures.
- Issue of building permits.
- Inspections during and after construction.
- Provision of evidentiary certificates.
- Issue of certificates of occupancy or compliance.
- Accreditation or approval of materials or components.
- Review and enforcement of standards.
- Fees and charges.

Administrative discretion

The Code is drafted with the object of reducing the need for the Approval Authority to make discretionary decisions.

However, in many cases it is not possible to draft a provision in purely technical terms and an informed judgement is required on the standard which would be suitable in particular circumstances.

Accordingly, in a number of clauses, the Code requires a particular material or construction method to be "suitable", meaning fit in all relevant respects for its intended purpose and use.

The Approval Authority responsible for the enforcement of building controls retains the right to question "suitability" and differences of opinion are open to appeal.

**NATIONAL
BUILDING
CODE
1990**

ALL BUILDINGS

SECTION A

GENERAL PROVISIONS

- | | |
|-----------|---|
| A1 | Interpretation |
| A2 | Acceptance of Design and Construction |
| A3 | Classification of Buildings and Structures |
| A4 | United Buildings |

SECTION A

THIS SECTION APPLIES TO ALL BUILDINGS

CONTENTS

Part		Part	
A1	Interpretation	A3	Classification of Buildings and Structures
A1.1	Definitions	A3.1	Principles of Classification
A1.2	Adoption of Standards and other references	A3.2	Classifications
A1.3	Referenced Standards, etc	A3.3	Multiple classification
A1.4	Differences between referenced documents and this Code	A4	United Buildings
A1.5	Mandatory provisions	A4.1	When buildings are united
A2	Acceptance of Design And Construction	A4.2	Alterations in a united building
A2.1	Suitability of materials		Specification
A2.2	Evidence of suitability		Specification A1.3 Standards Adopted by Reference.
A2.3	Fire-resistance of building elements		Specification A2.3 Fire-Resistance of Building Elements.
A2.4	Early Fire Hazard Indices		Specification A2.4 Early Fire Hazard Test for Assemblies.

INTERPRETATION

A1.1 Definitions

Some of the words and phrases used in the Code have specific defined meanings. Wherever such meaning is intended the words and phrases are printed in italics. The defined meanings are:

Alteration, in relation to a building, includes an addition or extension to a building.

Assembly building a building where people may assemble for -

- (a) civic, theatrical, social, political or religious purposes;
- (b) educational purposes in a *school, early childhood centre, preschool, or the like*;
- (c) entertainment, recreational or sporting purposes; or
- (d) transit purposes.

Atrium a space within a building that connects 2 or more *storeys*, and -

- (a) is wholly or substantially enclosed at the top by a floor or roof (including a glazed roof structure); and
- (b) includes any adjacent part of the building not separated by bounding construction; but
- (c) does not include a stairwell, rampwell or the space within a *shaft*.

Automatic applied to a fire door, smoke door, fire shutter, smoke and-heat vent, *sprinkler system*, alarm system or the like, means designed to operate when activated by a heat, smoke or fire sensing device.

Backstage a space associated with, and adjacent to, a *stage* in a Class 9b building for scenery, props, equipment, dressing rooms, or the like.

Certificate of Accreditation a certificate acceptable to the Approval Authority stating that the properties and performance of a building material or method of construction or design fulfil specific requirements of this Code.

Charged Dry Riser Main System one or more *riser mains* in a building complete with all *required* fittings, not permanently connected to a *fire main*. Instead of leaving the system dry, it is charged with water from any convenient domestic supply in order to make it self-monitoring against inadvertently left open *hydrant* valves and leakage.

Combustible -

- (a) applied to a material - means *combustible* under AS1530.1

- (b) applied to construction or part of a building - means constructed wholly or in part of *combustible* materials.

(See definition of *non-combustible*)

Common Wall a wall that is common to adjoining buildings.

Curtain Wall a non-loadbearing external wall that is not a *panel wall*.

Drain a line of pipes to carry *sewage* or *trade waste*, located within the property boundary, laid above or below ground, and includes all fittings and equipment such as inspection openings, traps and gullies.

It is a branch *drain* if it is intended to receive the discharge from fixture discharge pipes. Branch *drains* join a main *drain*.

The main *drain* collects the *waste water* from branch *drains* and/or from fixture discharge pipes and conveys them to the *sewer*.

Early Childhood Centre a preschool, kindergarten or child-minding centre.

Effective height the height to the floor of the topmost *storey* (excluding the topmost *storey* if it contains only heating, ventilating, lift or other equipment, water tanks or similar service units) from the floor of the highest *storey* providing egress to a road or *open space*. The road or *open space* must be capable of providing unobstructed access to emergency vehicles.

The *effective height* of a stepped or terraced building is the maximum *effective height* of any segment of the building.

Exit :

- (a) Any, or any combination of the following if they provide egress to a road or *open space*:
 - (i) An internal or external stairway.
 - (ii) A ramp complying with Section ND.
 - (iii) A *fire-isolated passageway*.
 - (iv) A doorway opening to a road or *open space*.
- (b) A *horizontal exit* or a *fire-isolated passageway* leading to a *horizontal exit*.

External Wall an outer wall of a building which is not a *common wall*.

Fire Brigade Booster Connection a connecting device enabling the fire brigade to pressurize or pump water into a *riser main* or other systems.

A1 INTERPRETATION

Fire Compartment a part of a building which is separated from the remainder in accordance with this Code to resist the spread of fire and smoke.

Fire-isolated Passageway a corridor, hallway or the like, of fire-resisting construction, which provides egress to or from a fire-isolated stairway or fire-isolated ramp or to a road or open space.

Fire-isolated Ramp a ramp within a fire-resisting enclosure which provides egress from a storey.

Fire-isolated Stairway a stairway within a fire-resisting shaft and includes the floor and roof or top enclosing structure.

Fire Main a water supply service pipe located outside a building to supply water at adequate pressures and rates of flow for fire fighting purposes. The fire main must be -

- (a) part of a public supply system kept permanently charged with water; or
- (b) privately provided in which case it must either be permanently charged with water from a reliable supply or be provided with adequate on site storage and fire pumps.

Fire-protective Covering inert material applied in such a manner that it protects other materials or building elements from the damaging effects of fire. Acceptable materials are:-

- (a) 13 mm fire-protective grade plasterboard;
- (b) 12 mm cellulose fibre reinforced sheeting;
- (c) 12 mm mesh-reinforced fibrous plaster in which the mesh is 13 mm x 13 mm x 0.7 mm welded wire located not more than 6 mm from the exposed face; or
- (d) other material not less fire-protective than 13 mm fire-protective grade plasterboard,

fixed in accordance with the normal trade practice for a fire-protective covering.

Fire-resistance Level (FRL) the grading periods in minutes determined in accordance with Specification A2.3, for-

- (a) structural adequacy;
- (b) integrity; and
- (c) insulation,

and expressed in that order.

Fire-resisting, applied to a structural member or other part of a building, means having the FRL required for that structural member or other part.

Fire-resisting Construction one of the Types of construction referred to in Part NC1.

Fire-separated Section a part of a building which is separated from the remainder by fire walls in accordance with Part NC2 and thereby regarded as a separate building.

Fire-source Feature -

- (a) the far boundary of a road adjoining the allotment;
- (b) a side or rear boundary of the allotment; or
- (c) an external wall of another building on the allotment which is not of Class 10.

Fire Wall a wall that divides a storey or building to resist the spread of fire and smoke and has the FRL required under Specification NC1.1.

Fixture Unit a unit of measure based on the rate of discharge, time of operation and frequency and use of a sanitary fixture, that denotes the hydraulic load contributed by that fixture to the sanitary plumbing system.

Flammability Index the index number determined under AS 1530.2.

Floor Area -

- (a) in relation to a storey - the area of that storey measured over the enclosing walls (if any) and that part of any common wall located within the allotment; and
- (b) in relation to a room - the area of the room measured within the finished surfaces of the walls, and includes the area occupied by any cupboard or other built-in furniture, fixture or fitting.

Habitable Room a room used for normal domestic activities, and -

- (a) includes a bedroom, living room, lounge room, music room, television room, kitchen, dining room, sewing room, study, playroom, family room and sunroom; but
- (b) excludes a bathroom, laundry, water closet, pantry, walk-in wardrobe, corridor, hallway, lobby, photographic darkroom, clothes-drying room, and other spaces of a specialised nature occupied neither frequently nor for extended periods.

Health-care Building -

- (a) a nursing home, hospital, convalescent home, infirmary or similar institution or home for sick or disabled persons needing full-time nursing care; or
- (b) a clinic or day surgery unit where -
 - (i) prescribed surgical procedures are performed on people who do not require overnight care as in-patients in a hospital; and

- (ii) the surgical procedures include a potential requirement for general anaesthesia, major regional anaesthesia or intravenous sedation.

Horizontal Exit a *required* doorway through a *required* fire wall separating two portions of a building with approximately the same floor level so as to establish an area of refuge affording safety from fire and/or smoke in the portion from which the escape is made.

Hydrant a fire service outlet fitting installed in a *riser main* or a *fire main* which provides a valved outlet to permit a controlled supply of water to be taken from the main for fire fighting. *Hydrants* installed in a *riser main* system within a building are referred to as internal *hydrants* and those installed in a *fire main* outside a building, as external *hydrants*.

Insulation, in relation to a FRL, means the ability to maintain a temperature on the surface not exposed to the furnace below the limits specified in AS 1530.4.

Integrity, in relation to a FRL, means the ability to resist the passage of flames and hot gases specified in AS 1530.4.

Internal Wall excludes a *common wall* or a party wall.

Junction a sanitary fitting used to connect one or more branch pipes or channels to a main pipe or channel.

A square *junction* connects the main pipe at right angles and has an airtight removable cap to facilitate inspection and cleaning.

An inspection branch is a *junction* with an airtight removable cap to facilitate inspection and cleaning.

Lightweight Construction see Specification NC1.5.

Loadbearing intended to resist forces and moments additional to those due to its own weight.

Mezzanine Floor an intermediate floor within a room which is not more than 1/3 of the floor area of the room or 200 m², whichever is the lesser.

Non-combustible -

- (a) applied to a material - means not *combustible* except that the material may have a *combustible* surface finish if the finish is not more than 1 mm thick and the *Spread-of-Flame Index* of the assemblage is 0;
- (b) applied to construction or part of a building - means constructed of *non-combustible* material on all exposed faces.

The following materials though *combustible* or containing *combustible* fibres may be used wherever *non-combustible* materials are required:-

- (i) plasterboard

- (ii) perforated gypsum lath with a normal paper finish
- (iii) fibrous plaster sheet conforming to AS 2185
- (iv) cellulose fibre cement sheeting
- (v) any other material not less fire-protective than any of the materials from (i) to (iv)

Open-deck Carpark a carpark in which all parts of the parking *storeys* are cross-ventilated by permanent unobstructed openings in not fewer than 2 opposite or approximately opposite sides, and -

- (a) where each side that provides ventilation is not less than 1/6 of the area of any other side; and
- (b) the openings are not less than 1/2 of the wall area of the side concerned.

Open Garage a carport or garage with 2 or more sides substantially open.

Open Space a space on an allotment, or a roof or similar part of a building complying with ND2.12, open to the sky and connected directly with a public road.

Open Spectator Stand a tiered stand substantially open at the front.

Panel Wall a non-loadbearing *external wall*, in frame or similar construction, that is wholly supported at each *storey*.

Pitch the maximum angle to the horizontal of a line connecting the nosings of stair treads in a single straight flight of a stairway.

Private Garage -

- (a) any garage of a Class 1 building; or
- (b) any single *storey* of a building of another Class capable of accommodating not more than 3 vehicles, if there is only one such *storey* in the building.

Professional Consultant a person with appropriate experience in the relevant field, being -

- (a) if legislation so requires - a registered *professional consultant* in the relevant discipline; or
- (b) a Corporate Member of a recognized professional institution.

Public Corridor an enclosed corridor, hallway or the like which -

- (a) serves as a means of egress from 2 or more *sole-occupancy units* to a *required exit* from the *storey* concerned; or
- (b) is *required* to be provided as a means of egress from any portion of a *storey* to a *required exit*.

A1 INTERPRETATION

Public Carpark a building that is used for the parking of motor vehicles but is neither a *private garage* nor used for the servicing of vehicles, other than washing, cleaning or polishing.

Registered Testing Authority -

- (a) National Building Technology Centre
P O Box 30
CHATSWOOD NSW 2067
AUSTRALIA;
- (b) Council of Scientific and Industrial Research
Organisation; Division of Building Research
P O Box 56
HIGHETT VIC 3190
AUSTRALIA;
- (c) An organisation registered by the National
Association of Testing Authorities (NATA) to test in
the relevant field;
- (d) Building Research Association of New Zealand
Private Bag
PORIRUA
NEW ZEALAND;
- (e) Testing laboratories registered by the Testing
Laboratory Registration Council (TELARC) of New
Zealand to test in the relevant field;
- (f) An organisation recognized by NATA or TELARC
through a mutual recognition agreement;
- (g) Fire Insurers Research and Testing Organisation
Melrose Avenue
BOREHAMWOOD
LONDON (UK);
- (h) National Institute of Standards and Technology
GAITHERSBURG, MD 20899
USA;
- (i) Underwriters Laboratories Incorporated
333 Pfingsten Road
NORTHBROOK, IL 60062
USA; or
- (j) National Research Council
Division of Building Research
75 Boul De Mortagne
Boucherville
Quebec
CANADA

Repairs action taken to restore the structural strength or appearance of a building without making any addition or extension to it.

Required *required* by this Code.

Resistance to the incipient spread of Fire in relation to a ceiling membrane, means the ability of a ceiling membrane to insulate the space between the ceiling and roof, or ceiling

and floor above, to limit the temperature rise of combustibles in this space during the *Standard Fire Test* to 180°C.

Rise, in storeys, means the greatest number of storeys calculated in accordance with NC 1.2 at any part of the external walls of the building -

- (a) above the finished ground next to that part; or
- (b) if part of the external wall is on the boundary of the allotment, above the natural ground level at the relevant part of the boundary.

Riser Main a pipe to convey water for fire brigade use to all floors of a building and where appropriate to the roof. A riser main system must consist of either a *wet riser main system* or a *charged dry riser main system*.

Sanitary Compartment a room or space containing a toilet fixture, closet pan, soil pan, chemical toilet, or the like.

Sarking-type Material a material such as a reflective foil or other flexible membrane of a type normally used for a purpose such as water-proofing, vapour proofing or thermal reflectance.

School includes a primary or secondary school, college, university or similar educational establishment.

Self-closing, applied to a door or window means equipped with a device which returns the door or window to the fully closed and latched position immediately after each manual opening.

Service Station a garage which is not a *private garage* and is for the servicing of vehicles, other than only washing, cleaning or polishing.

Sewage waterborne human waste from domestic and commercial premises including faeces and urine, and waste from kitchens, showers, baths, domestic laundries etc.

Sewer a conduit vested in a public authority and located outside the property boundary. It is used for the conveyance of waste water.

Shaft the walls and other parts of a building bounding -

- (a) a well, other than an *atrium well*; or
- (b) a vertical chute, duct or similar passage, but not a chimney or flue.

Site the part of the allotment of land on which a building stands or is to be erected.

Smoke-and-heat Vent a vent, located in or near the roof for smoke and hot gases to escape if there is a fire in the building.

Smoke-Developed Index the index number for smoke developed under AS 1530.3.

Soil Fixture a water closet pan, urinal, sanitary napkin disposal unit, slop hopper, bed pan washer or autopsy table.

Soil Pipe a pipe which conveys discharge from *soil fixtures*.

Sole-occupancy Unit a room or other portion of a building for occupation by one owner, lessee, tenant, or other occupier to the exclusion of any other owner, lessee, tenant, or other occupier.

Spread-of-Flame Index the index number for spread of flame under AS 1530.3.

Sprinkler System a system of *automatic* fire sprinklers complying with NE1.5.

Stack a vertical *drain* including offsets and extending to more than one *storey*.

Stage a floor or platform in Class 9b building on which performances are presented before an audience.

Standard Fire Test the Fire-resistance Test of Structures under AS 1530.4.

Storey a space within a building which is situated between one floor level and the floor level next above, or if there is no floor above, the ceiling or roof above, but not -

- (a) a space that contains only -
 - (i) a lift *shaft*, stairway or meter room;
 - (ii) a bathroom, shower room, water closet, or other *sanitary compartment*; or
 - (iii) 3 vehicles or less; or
 - (iv) a combination of the above; or
- (b) a *mezzanine floor*.

Structural Adequacy, in relation to a FRL means the ability to maintain stability and adequate *loadbearing* capacity under AS1530.4.

Structural Member a component or part of an assembly which provides vertical or lateral support to a building or structure.

Sweep Junction a long radius bend entering a main pipe at 45° or a 45° junction fitted with a 45° bend.

Swimming Pool any excavation or structure containing water and used for swimming, wading, paddling, or the like, including a bathing or wading pool, or spa.

Trade Waste waterborne waste from business, trade or manufacturing process containing predominantly non-human waste, but not unpolluted water.

Ward Area that portion of a *storey* of a Class 9a building for residing patients and includes areas for sleeping, recreation and sanitary facilities, and nurses stations.

Waste Fixture a sanitary fixture other than a *soil fixture*. Examples are: basins, bidets, kitchen sink, laundry trough etc.

Waste Pipe a pipe which conveys the discharge from *waste fixtures*.

Waste Water dissolved and suspended waterborne waste which may consist of *sewage* and/or *trade waste*.

Wet Riser Main System one or more *riser mains* in a building with all *required* fittings, permanently charged with water from a *fire main*. The term includes all associated pipe work from the point of connection to a *fire main*.

Window includes a roof light, glass panel, glass brick, glass louvre, glazed sash, glazed door, or other device which transmits natural light directly from outside a building to the room concerned when in the closed position.

A1.2 Adoption of Standards and other references

The adoption of a Standard, rule, specification or provision included in any document issued by the Standards Association of Australia, Standards Association of New Zealand or other body, does not include a provision -

- (a) specifying the respective rights, responsibilities or obligations between that body and any manufacturer, supplier or purchaser;
- (b) specifying the responsibilities of any tradesman or other building operative, architect, engineer, authority, or other person or body;
- (c) requiring the submission for approval of any material, building component, form or method of construction, to any person, authority or other body;
- (d) specifying that a material, building component, form or method of construction, must be submitted to the Standards Association of Australia, Standards Association of New Zealand or other body or a committee of either Association for expression of opinion; or
- (e) permitting a departure from the Standard, rule, specification or provision at the sole discretion of the manufacturer or purchaser, or by arrangement or agreement between the manufacturer and purchaser.

A1 INTERPRETATION

A1.3 Referenced Standards, Etc.

A reference to a document under A1.2 refers to the latest edition or issue, together with any amendment, listed in Specification A1.3 and only so much as is relevant in the context in which the document is quoted.

A1.4 Differences between referenced documents and this Code

This Code overrules in any difference arising between it and any Standard, rule, specification or provision in a document listed in Specification A1.3. Further, references in this Code to any Standard or Code of Practice issued by the Standards Association of Australia or of New Zealand or such other body, exclude the need for:

- (a) compliance with NZS 1900 wherever it is quoted in any standard;
- (b) compliance with any laws and regulations that are not of this country; and

- (c) recognition of the meaning of "Engineer".

Also, references to "FRR" in Standards issued by the Standards Association of New Zealand mean "Fire resistance level" as defined in this Code.

A1.5 Mandatory provisions

- (a) The following provisions of the Code are mandatory:

- (i) all provisions of Section A; and
- (ii) the Performance Requirements stated at the beginning of all the other Sections.

- (b) The Deemed-to-Satisfy Provisions of the Code are one means of satisfying the Performance Requirements. The Performance Requirements can also be met by any other means. When this latter approach is taken, it must meet the final objectives and performance that would have been achieved had the Deemed-to-Satisfy Provisions been followed.

ACCEPTANCE OF DESIGN AND CONSTRUCTION

A2.1 Suitability of materials

Every part of a building must be constructed in a manner which will achieve the required level of performance, using materials and methods that are not faulty or unsuitable for the purpose for which they are intended.

A2.2 Evidence of suitability

Evidence to support the use of a material, method, form of construction or design may be -

- (a) a report issued by a *Registered Testing Authority*, showing that the material or form of construction has been submitted to the tests listed in the report, and setting out the results of those tests and any other relevant information that demonstrates its suitability for use in the building;
- (b) a current *Certificate of Accreditation*;
- (c) a certificate from an appropriately qualified *professional consultant* which -
 - (i) certifies that a material, design or form of construction complies with the requirements of this Code; and
 - (ii) sets out the basis on which it is given and the extent to which relevant specifications, rules,

codes of practice or other publications have been relied upon; or

- (d) a Standards Mark Certificate issued by the Standards Association of Australia or the Standards Association of New Zealand; or
- (e) any other form of documentary evidence that correctly describes the properties and performance of the material or form of construction and adequately demonstrates its suitability for use in the building,

and any copy of documentary evidence submitted under this Code, must be a complete copy of the original report or document.

A2.3 Fire-resistance of building elements

The FRL of a *structural member* or other building element must be determined in accordance with Specification A2.3. Any relevant testing or certification must be by an appropriately qualified *professional consultant* or *Registered Testing Authority*.

A2.4 Early Fire Hazard Indices

The Early Fire Hazard Indices of a component or assembly must be determined in accordance with Specification A2.4.

CLASSIFICATION OF BUILDINGS AND STRUCTURES

A3.1 Principles of classification

The classification of a building or part of a building is determined by the purposes for which it is designed, constructed or adapted to be used.

A3.2 Classifications

Buildings are classified as follows:-

Class 1: a residence which may comprise one or more buildings including any habitable outbuildings which in association constitute -

- (a) a single dwelling-house; or
- (b) a terrace house, townhouse or the like which may be detached or separated by a *common wall*; or
- (c) a dwelling-house used as a boarding-house, hostel, or the like, in which not more than 12 persons would ordinarily be resident; or
- (d) a building that does not exceed a *rise* of 3 storeys and contains -
 - (i) 2 or more *sole-occupancy units* where no such unit is located one above the other; or
 - (ii) only 2 *sole-occupancy units* located one above the other,

and each unit has direct egress to a road or *open space*.

Class 2: a building containing 2 or more *sole-occupancy units* each being a separate dwelling, other than a building of Class 1.

Class 3: a residential building, other than a building of Class 1 or 2, which is a common place of living for a number of unrelated persons, including -

- (a) a boarding-house, guest house, hostel, or lodging-house;
- (b) a residential part of an hotel or motel;
- (c) a residential part of a *school*;
- (d) accommodation for the aged, disabled or children; and
- (e) a residential part of a *health-care building* which accommodates members of staff.

Class 4: a dwelling in a building that is Class 5, 6, 7, 8 or 9 if it is the only dwelling in the building.

Class 5: an office building used for professional or commercial purposes, excluding buildings of Class 6, 7 or 8.

Class 6: a shop or other building for the sale of goods by retail or the supply of services direct to the public, including-

- (a) an eating room, cafe, restaurant, milk or soft-drink bar;
- (b) a dining room, bar, shop or kiosk portion of an hotel or motel;
- (c) a hairdresser's or barber's shop, public laundry, or undertaker's establishment;
- (d) market or sale room, show room, or service station.

Class 7: a building which is -

- (a) for storage, or display of goods or produce for sale by wholesale; or
- (b) a *public carpark*.

Class 8: a laboratory, or a building in which a handicraft or process for the production, assembling, altering, repairing, packing, finishing, or cleaning of goods or produce is carried on for trade, sale, or gain.

Class 9: a building of a public nature -

- (a) **Class 9a** - a *health-care building*;
- (b) **Class 9b** - an *assembly building*; and

Class 9a includes a pathology laboratory in a *health-care building* and Class 9b includes a trade workshop in a primary or secondary *school*, but excludes any other part of these buildings that are of another Class.

Class 10: a non-habitable outbuilding or structure -

- (a) **Class 10a** - a carport, *private garage*, shed or the like;
- (b) **Class 10b** - a fence, mast, antenna, retaining or free-standing wall, *swimming pool*, or the like.

A3.3 Multiple classification

Each part of a building must be classified separately, and-

- (a) where parts have different purposes - if not more than 10% of the *floor area* of *storey* which is not a laboratory is used for a purpose which is a different classification, the classification applying to the major use may apply to the whole *storey*;

- (b) Classes 9a, 9b, 10a and 10b are separate classifications; and
- (c) a reference to -

- (i) Class 9 - is to Class 9a or 9b; and
 - (ii) Class 10 - is to Class 10a or 10b.
-

UNITED BUILDINGS

A4.1 When buildings are united

Two or more buildings adjoining each other are considered to form one united building if they -

- (a) are connected through openings in the walls dividing them; and
- (b) together comply with all the requirements of this Code as though they are a single building.

A4.2 Alterations in a united building

After any *alteration* or any other action -

- (a) a united building; or
- (b) each building forming part of a united building; or
- (c) each building if they cease to be connected through openings in the dividing walls,

must comply with all requirements for a single building.

STANDARDS ADOPTED BY REFERENCE

1. Schedule of referenced documents

The Standards and other documents listed in Table 1 are referred to in this Code. In order to reduce possible confusion/conflict, the Standards produced by the Standards Association of Australia or by the Standards Association of New Zealand as seen to be specifically relevant, have been called up. However the Code users are free to use any

suitable mix of Australian and New Zealand Standards provided care is taken to follow consistent technical principles and prevalent practices. Where the Standards from either Australia or New Zealand do not cover any specific area, the relevant Standards issued by the British Standards Institution or the American Society for Testing and Materials may be used.

TABLE 1
SCHEDULE OF REFERENCED DOCUMENTS

No.	Title	Code Clause(s)
AS 1038	Methods for the analysis and testing of coal and coke	
Part 15	Fusibility of higher rank coal ash and coke ash	Spec NC3.15
AS 1170	Minimum design loads on structure (SAA Loading Code)	B1.2
Part 2	Wind forces	
AS 1349	Bourdon tube pressure and vacuum gauges	Spec NE1.2
AS 1428	Design rules for access by the disabled	ND3.2, ND3.3, NF2.5
Part 1	Regulatory requirements	
AS 1530	Methods of fire tests on building materials components and structures	A1.1
Part 1	Combustibility test for materials	
Part 2	Test for flammability of materials	
Part 3	Test for early fire hazard properties of materials	Spec A2.4
Part 4	Fire-resistance tests on elements of building construction	Spec A2.4 Spec NC3.15
AS 1657	Rules for fixed platforms, walkways, stairways and ladders	ND2.18, NH1.6 DF6.11.5
AS 1664	Rules for the use of aluminium in structures (SAA Aluminium Structures Code)	B1.3
AS 1668	Rules for the use of mechanical ventilation and air-conditioning in buildings (SAA Mechanical Ventilation and Air-conditioning Code)	
Part 1	Fire precautions in buildings with air-handling systems	NC3.15, NE2.7 Spec NE1.8
Part 2	Ventilation requirements	Spec NE1.9, NH1.2 DF4.5, NF4.5, NF4.11

TABLE 1 Continued
SCHEDULE OF REFERENCED DOCUMENT

No.	Title	Code Clause(s)
AS 1670	Automatic fire alarm installations (SAA Code for Automatic Fire Alarm Installations)	Spec NE1.8 NE2.5
AS 1694	Code of practice for physical barriers used in the protection of buildings against subterranean termites	B1.3
AS 1720	Rules for the use of timber in structures (SAA Timber Engineering Code)	B1.3 Spec A2.3
AS 1735	Design, installation, testing and operation of lifts, escalators and moving walks (SAA Lift Code)	
Part 2	Passenger and goods lifts - Electric	Spec NC1.5 NE3.4
Part 11	Fire-rated landing doors	NC3.10
Part 12	Facilities for persons with disabilities	ND3.3
AS 1736	Code of practice for pliable roof sarking	DF1.5, NF1.5
AS 1860	Code of practice for the installation of particleboard flooring	B1.3
AS 1903	Reflective foil laminate	DF1.5, NF1.5
AS 1904	Code of practice for installation of reflective foil laminate in buildings	DF1.5, NF1.5
AS 1926	Fences and gates for private swimming pools	DG1.1 NG1.1
AS 2057	Soil treatment of buildings under construction for protection against subterranean termites	B1.3
AS 2107	Code of practice for ambient sound levels for areas of occupancy within buildings	Spec NE1.9
NZS 2139	Heat actuated fire detectors	Spec NE1.8
AS 2159	Rules for the design and installation of piles (SAA Piling Code)	B1.3
AS 2179	Metal rainwater goods - Specification	NF7.2
AS 2180	Metal rainwater goods - Selection and installation	NF7.2 Spec NF7.2
AS 2185	Fibrous plaster products	Spec NC1.5
AS 2293	Emergency evacuation lighting in buildings	
Part 1	Design and installation	NE4.4, NE4.8

TABLE 1 Continued
SCHEDULE OF REFERENCED DOCUMENT

No.	Title	Code Clause(s)
AS 2327	Composite construction in structural Steel and concrete (SAA Composite Construction Code)	Spec A2.3,
AS2601	The demolition of structures	B2.2
AS 2665	Smoke/heat venting systems	NC2.3, NE2.5 Spec NE2.6
AS 2818	Guide to swimming pool safety	DG1.1, NG1.1
AS 2870	Residential slabs and footings	
Part 1-XXXX	Construction	B1.3, DF1.9, NF1.9
AS 2904	Damp-proof courses and flashings	DF1.8, NF1.8
AS 3000 NE6.1.1	SAA Wiring rules	DE1.1,
NZS 3101	The design of concrete structures	B1.3
Parts 1 and 2		
NZS 3109	Specification for concrete construction	B1.3
NZS 3124	Specification for concrete construction for minor works	B1.3
NZS 3404	Code for design of steel structures (incorporating AS 1250)	B1.3
AS 3500	Plumbing and drainage Code	
Part 0	Glossary of terms	
Part 1	Water supply	DF5.2, DF5.3, NF5.2, NF5.3
Part 2	Sanitary plumbing and sanitary drainage	DF6.2, NF6.2
Part 4	Hot water supply systems	DF5.2, DF5.3, DF5.4, NF5.2, NF5.3, NF5.4
AS 3600	Concrete Structures	Spec A2.3
NZS 3603	Code of practice for timber design	B1.3
AS 3700	Masonry in building (SAA Masonry Code)	Spec A2.3
AS 4100	Steel Structures	Spec A2.3
NZS 4121	Design for access and use of buildings and facilities by disabled persons	ND3.2, ND3.3, NF2.5

A1.3 STANDARDS ADOPTED BY REFERENCE
**TABLE 1 Continued
SCHEDULE OF REFERENCED DOCUMENTS**

No.	Title	Code Clause(s)
NZS 4122	Guide to approachability, accessibility and usability of buildings	ND3.2, ND3.3, NF2.5
NZS 4203	General structural design and design loadings for buildings -	B1.2, B 1.4
Part 1	General	
Part 2	Dead and live loads	
Part 3	Earthquake provisions	
NZS 4210	Code of practice for masonry buildings, materials and workmanship	Spec A2.3, B1.9
NZS 4223	Code of practice for glazing in buildings	B1.3, Fig B1.4
NZS 4229	Code of practice for masonry buildings not requiring specific design	B1.3
NZS 4230	Code of practice for the design of masonry structures	B1.3
NZS 4232	Performance criteria for fire resisting closures	Spec NC 3.4, NC3.6
NZS 4503	Hand operated fire fighting equipment	NE1.5, NE1.7
NZS 4504	Specification for fire hose reels	NE1.5
NZS 4510	Code of practice for riser mains for fire service use	NE1.2 NE1.3
NZS 4512	Automatic fire alarm systems in buildings	Spec NE1.8, NE2.5
NZS 4541	Automatic fire sprinkler systems	Table NC2.2, Spec NE1.2, Spec NE1.6
NZS 4561	Specification for manual fire alarm systems for use in buildings	Spec NE1.8
NZS 6742	Emergency lighting in buildings	NE4.4, NE4.8
TR 440	NBTC Technical Record 440 - Guidelines for the testing and evaluation of Products for cyclone-prone areas	B1.3
AISC	Guidelines for assessment of fire resistance of structural steel members	Spec A2.3
ASTM E72-80	Standard method of conducting strength tests of panels for building construction	Spec NC1.5
ASTM E695-79	Method for measuring relative resistance of wall, floor and roof construction to impact loading (1985)	Spec NC1.5

FIRE-RESISTANCE OF BUILDING ELEMENTS

1. Scope

This Specification sets out the procedure for determining the FRL of *structural members* and other building elements.

2. Rating

A building element has a FRL if -

- (a) it is listed in, and complies with Table 1 of this Specification;
- (b) it is identical with a prototype that has been submitted to the *Standard Fire Test* and the FRL achieved by the prototype is confirmed in a report from a *Registered Testing Authority* which -
 - (i) describes the method and condition of test and the form of construction of the tested prototype in full; and
 - (ii) certifies that the application of restraint to the prototype complied with the *Standard Fire Test*;
- (c) it differs in only a minor degree from a prototype tested under (b) and the FRL attributed to the *structural member* is confirmed in a report from a *Registered Testing Authority* which -
 - (i) certifies that the *structural member* is capable of achieving the FRL despite the minor departures from the tested prototype; and
 - (ii) describes the materials, construction and conditions of restraint which are necessary to achieve the FRL;
- (d) it is designed to achieve the FRL in accordance with-
 - (i) AS 4100, AS 2327 and AISC *Guidelines for Assessment of Fire Resistance of Structural Steel Members* if it is a steel or composite structure; or
 - (ii) AS 3600 if it is a concrete structure; or
 - (iii) AS 1720.4 if it is a solid or glued-laminated timber structure.
- (e) the FRL is determined by calculation based on the performance of a prototype in the *Standard Fire Test* and confirmed in a report in accordance with clause 3.

3. FRLs determined by calculation

If the FRL of a building element is determined by calculation based on a tested prototype -

- (a) the building element may vary from the prototype in relation to -
 - (i) length and height if it is a wall;
 - (ii) height if it is a column;
 - (iii) span if it is a floor, roof or beam;
 - (iv) conditions of support; and
 - (v) to a minor degree, cross-section and components.
- (b) the report must demonstrate by calculation that the building element would achieve the FRL if it is subjected to the regime of the *Standard Fire Test* in relation to -
 - (i) *structural adequacy* (including deflection);
 - (ii) *integrity*; and
 - (iii) *insulation*; and
- (c) the calculations must take into account -
 - (i) the temperature reached by the components of the prototype and their effects on strength and modulus of elasticity;
 - (ii) appropriate features of the building element such as support, restraint, cross-sectional profile, length, height, span, slenderness ratio, reinforcement, ratio of surface area to mass per unit length, and fire protection;
 - (iii) features of the prototype that influenced its performance in the *Standard Fire Test* although these features may not have been taken into account in the design for dead and live load;
 - (iv) features of the conditions of test, the manner of support and the position of the prototype during the test, that might not be reproduced in the building element if it is exposed to fire; and
 - (v) the design load of the building element in comparison with the tested prototype.

A2.3 FIRE-RESISTANCE OF BUILDING ELEMENTS

4. Interchangeable materials

- (a) **Concrete and plaster** - The FRL achieved with any material of Group A, B, C, D or E as an ingredient in concrete or plaster, applies equally when any other material of the same group is used in the same proportions:

Group A: Any portland cement.

Group B: Any lime.

Group C: Any dense sand.

Group D: Any dense calcareous aggregate, including any limestone or any calcareous gravel.

Group E: Any dense siliceous aggregate, including any basalt, diorite, dolerite, granite, granodiorite or trachyte.

- (b) **Perlite and vermiculite** - The FRL achieved with either gypsum perlite plaster or gypsum-vermiculite plaster applies equally for both plasters.

5. Columns covered with lightweight construction

- (a) **Protection against injury** - If the fire-resisting covering of a steel column is *lightweight* construction -

(i) the covering must be protected by metal or other suitable material if the column is liable to damage from the movement of vehicles, materials or equipment; and

(ii) the voids must be filled solid with non-combustible material to a height of not less than 1.2 m above the floor to prevent indenting if the covering is not in continuous contact with the column; and

- (b) **Sealing at floor level** - A plug of non-combustible material must seal all voids at each floor level, including voids between the column and its covering if -

(i) a steel column extends through 2 or more storeys; and

(ii) the fire-resisting covering is not in continuous contact with the column.

TABLE 1
FRLs DEEMED TO BE ACHIEVED BY CERTAIN BUILDING ELEMENTS

BUILDING ELEMENT	THICKNESS OF PRINCIPAL MATERIAL (mm)			ANNEXURE REFERENCE Clause No.
	60/60/60	90/90/90	120/120/120	
WALL				
Masonry -				
Concrete with material density in kg/m ³ of -				
- 1600 or more	80	100	120	1,2,3,4,5
- less than 1600	70	90	110	1,2,3,4,5
Concrete				
- Reinforced/Prestressed	see 2 (d) (ii) of this Specification and 6 of Annexure to this Table			
Gypsum-perlite or Gypsum-vermiculite plaster on metal lath and channel				
	50	50	65	1,5,7
CONCRETE COLUMN				
Concrete-				
- Reinforced/Prestressed	see 2(d) (ii) of this Specification and clause 6 of Annexure of this Table			
HOT-ROLLED STEEL COLUMN (Including a fabricated column) exposed on no more than 3 sides:				
Fire protection of-				
Concrete - Cast in-situ-				
- loadbearing	25			8,9,10,11
<i>non-loadbearing -</i>				
- unplastered	25	30	40	8,9,10,11
- plastered 13 mm	25	25	30	1,5,8,9,10,11
Gypsum-perlite or Gypsum vermiculite plaster				
- sprayed to contour	20	25	35	1,10
- sprayed on metal lath	20	20	25	1,7

TABLE 1 Continued
FRLs DEEMED TO BE ACHIEVED BY CERTAIN BUILDING ELEMENTS

BUILDING ELEMENT	THICKNESS OF PRINCIPAL MATERIAL (mm)			ANNEXURE REFERENCE Clause No.
	60/60/60	90/90/90	120/120/120	
HOT-ROLLED STEEL COLUMN (including a fabricated column) exposed on no more than 3 sides:				
Fire protection of -				
Solid concrete masonry -				
column spaces filled	50	50	50	1,2,3,4,5,8,9,11
column spaces unfilled	50	50	65	1,2,3,4,5,8,11
	60/-/-	90/-/-	120/-/-	
HOT-ROLLED STEEL COLUMN (including a fabricated column) exposed on 4 sides:				
Fire protection of -				
Concrete - Cast in situ -				
- loadbearing	25	40	45	8,9,10,11
non-loadbearing -				
- unplastered	25	30	40	8,9,10,11
- plastered 13 mm	25	25	30	1,5,8,9,10,11
Gypsum-perlite or Gypsum-vermiculite plaster				
- sprayed to contour	25	30	40	1,10
- sprayed on metal lath	20	20	30	1,7
HOT-ROLLED STEEL COLUMN (including a fabricated column) exposed on 4 sides:				
Fire protection of -				
Solid concrete masonry				
column spaces filled	50	50	50	1,2,3,4,5,8,9,11
column spaces unfilled	50	50	50	1,2,3,4,5,8,11

TABLE 1 Continued
FRLs DEEMED TO BE ACHIEVED BY CERTAIN BUILDING ELEMENTS

BUILDING ELEMENT	THICKNESS OF PRINCIPAL MATERIAL (mm)			ANNEXURE REFERENCE Clause No.
	60/60/60	90/90/90	120/120/120	
BEAM				
Concrete-				
Reinforced/Prestressed see 2(d)(ii) of this Specification and clause 6 of Annexure to this Table				
Hot-Rolled Steel (including an open-web joist, girder, truss, etc.) exposed on no more than 3 sides :				
Fire protection of -				
Concrete - Cast in situ-	25	30	40	8,10,11
Gypsum-perlite or Gypsum vermiculite plaster				
- sprayed to contour	20	25	35	1,10
- sprayed on metal lath	20	20	25	1,7
	60/ - / -	90/ - / -	120/ - / -	
Hot-rolled Steel (incl. an open-web joist, girder, truss, etc.) exposed on 4 sides:				
Fire protection of -				
Concrete - Cast in situ-	25	40	45	8,10,11
Gypsum-perlite or Gypsum-vermiculite plaster				
- sprayed to contour	25	30	40	1,10
- spread on metal lath	20	20	30	1,7
	60/60/60	90/90/90	120/120/120	

FLOOR, ROOF OR CEILING

Concrete-

Reinforced/Prestressed see 2 (d) (ii) of this Specification and clause 6 of Annexure to this Table

ANNEXURE TO TABLE 1

1. MORTAR, PLASTER AND PLASTER REINFORCEMENT**1.1 Mortar for masonry**

Masonry units of concrete must be laid in cement mortar or composition mortar complying with the relevant provisions of NZS 4210.

1.2 Gypsum-perlite and gypsum-vermiculite plaster

Gypsum-perlite or gypsum-vermiculite plaster must be applied -

- (a) - in either one or 2 coats each in the proportions of 1 m³ of perlite or vermiculite to 640 kg of gypsum if the *required* thickness of the plaster is not more than 25 mm; and
- (b) in 2 coats if the *required* thickness is more than 25 mm, the first in the proportion of 1 m³ of perlite or vermiculite to 800 kg of gypsum and the second in the proportion of 1 m³ of perlite or vermiculite to 530 kg of gypsum.

1.3 Plaster of cement and sand or cement, lime and sand

Plaster prescribed in Table 1 must consist of -

- (a) cement and sand or cement, lime and sand; and
- (b) may be finished with gypsum, gypsum-sand, gypsum-perlite or gypsum-vermiculite plaster or with lime putty.

1.4 Plaster reinforcement

If plaster used as fire-protection on walls is more than 19 mm thick-

- (a) it must be reinforced with expanded metal lath that-
 - (i) has a mass per unit area of not less than 1.84 kg/m²;
 - (ii) has not fewer than 98 meshes/m; and
 - (iii) is protected against corrosion by galvanising or other suitable method; or
- (b) 13 mm x 13 mm x 0.710 mm galvanised steel wire mesh; and
- (c) the reinforcement must be securely fixed at a distance from the face of the wall of not less than 1/3 of the total thickness of the plaster.

2. DIMENSIONS OF MASONRY

The thickness of masonry of calcium-silicate, concrete and fired clay are calculated as follows:-

2.1 Solid units

For masonry in which the amount of perforation or coring of the units does not exceed 25% by volume (based on the overall rectangular shape of the unit) the thickness of the wall must be calculated from the manufacturing dimensions of the units and the specified thickness of the joints between them as appropriate.

2.2 Hollow units

For masonry in which the amount of perforation or coring of the units exceeds 25% by volume (based on the overall rectangular shape of the unit) the thickness of the wall must be calculated from the equipment thicknesses of the units and the specified thickness of the joints between them as appropriate.

2.3 Equivalent thickness

The equivalent thickness of a masonry unit is calculated by dividing the net volume by the area of one vertical face.

2.4 Cavity walls

The thickness of a cavity wall is the sum of the thicknesses of the leaves determined in accordance with 2.1 and/or 2.2 as appropriate.

2.5 Cavity walls of different materials

If the 2 leaves of a cavity wall are of units of different type, the thickness required is that listed for the less fire-resistant material (i.e. the greater thickness).

3. SLENDERNESS RATIO OF MASONRY**3.1 Maximum value**

The slenderness ratio of a masonry wall must not exceed the appropriate value in Table 3.1.

3.2 Calculation

The slenderness ratio of a masonry wall is calculated in accordance with AS 3700. In the case of cavity walls it is calculated for each leaf separately. Each leaf must satisfy 3.1.

**TABLE 3.1
MAXIMUM SLENDERNESS RATIOS FOR MASONRY WALLS**

TYPE OF UNIT			
	60/60/60	90/90/90	120/120/120
Concrete in which the basalt content of the aggregate is			
less than 45%	18	17	16
45% or more	22.5	21	19.5
Reinforced masonry - all types of unit designed for-			
axial forces and flexure-	27	27	27
flexure-with super-imposed axial forces less than 5% of load capacity-	36	36	36

4. PROTECTION TO MASONRY REINFORCEMENT

In a building element of reinforced masonry designed for fire-resistance, the distance from the surface of the element to the surface of the reinforcement must not be less than -

- (a) for FRL 60/60/60 or 90/90/90 - 30 mm;
- (b) for FRL 120/120/120 - 40 mm;

5. INCREASE IN THICKNESS BY PLASTERING

5.1 General

The tabulated thicknesses are those of the principal material. They do not include the thickness of plaster which must be additional to the listed thickness of the material to which it is applied.

5.2 Walls

If a wall of concrete masonry is plastered on both sides to an equal thickness, the thickness of the wall for the purposes of Table 1 (but not for the purposes of Table 3.1) may be increased by the following proportions of the thickness of the plaster on one side:

- (a) For concrete masonry in which the aggregate is of a density in excess of 1800 kg/m³ : 100%
- (b) For concrete masonry in which the aggregate is of a density between 1600 and 1800 kg/m³ : 85%

- (c) For concrete masonry in which the aggregate is of a density less than 1600 kg/m³ : 75%

6. CONCRETE SLABS BEAMS WALLS AND COLUMNS

The requirements to meet specific values of FRL are those contained in AS 3600. However for simple structures the following procedures may be adopted.

6.1 Structural adequacy criterion

Table 6.1A gives the minimum dimensions for meeting specific levels of structural adequacy for -

- (a) Solid or hollow core plain slabs - the clear cover to the longitudinal reinforcement or tendons. A slab is continuous if it is flexurally continuous along at least one edge under the imposed loads.
- (b) Ribbed slabs with ribs spaced at not more than 1200 mm centre to centre - the minimum width of the rib and the clear cover to the reinforcement or tendons of the ribs. The slabs spanning the ribs may be treated as plain slabs as at (a).
- (c) Beams - The upper surface of the beams must be integral with a slab or protected by one - the minimum width of web (rectangular or uniformly tapering cross-section) and the clear cover to the reinforcement or tendons.

A2.6 FIRE-RESISTANCE OF BUILDING ELEMENTS

- (d) Solid or hollow - the clear cover to the reinforcement or tendons. The effective thickness of the wall must be at least equal to that given in Table 6.3 for the FRL for the *insulation* criterion equal in period to the *required structural adequacy* criterion. In addition the slenderness ratio must not exceed the values given in Table 6.1B.
- (e) Columns which are -
- exposed on all sides of fire
 - built into or form part of a wall that does not have a fire separating function
 - built into or form part of a wall that has a lower value of *structural adequacy* than *required* for the column; or
 - built into and protrude by a distance in excess of the value of the clear cover to the longitudinal reinforcement.

6.2 Integrity criterion

This criterion is relevant only for slabs and walls and not for ribs, beams and columns. It is satisfied if the criteria for *structural adequacy* and *insulation* are met for the period equal to that *required* for the *integrity* of the slab or wall as appropriate.

6.3 Insulation criterion

This criterion is also relevant only for slabs and walls. It is met by meeting the requirement for minimum effective thickness as given in Table 6.3. The effective thickness of solid slabs and walls is the actual thickness. The effective thickness of hollow core slabs and walls is the value of the net cross-sectional area divided by the width of the cross-section. With hollow core slabs and walls the thickness of concrete between voids and between any part of a void and the nearest surface must be not less than 25 mm or 20% of the effective thickness of the slab.

**TABLE 6.1A
FRL - REQUIREMENTS FOR STRUCTURAL ADEQUACY CRITERION**

BUILDING ELEMENT	FRL (Minutes)			
	30	60	90	120
Plain Slabs				
- Simply supported one-way, clear cover (mm) to				
. reinforcement	15	20	25	30
. tendons	20	25	35	40
- Simply supported two way, clear cover (mm) to				
. reinforcement	10	15	20	25
. tendons	15	20	30	35
Continuous one-way and two-way, clear cover (mm) to				
. reinforcement	10	15	15	15
. tendons	15	20	25	25
Ribs of plain slabs min. width x clear cover (mm) (mm)				
- simply supported one-way and two-way ribbed slabs				
. reinforcement	80x15	110x25	135x35	150x45
. tendons	80x25	110x35	135x45	150x55
- continuous one way and two-way ribbed slabs min. width x clear cover (mm) (mm)				
reinforcement	70x15	75x20	110x25	125x35
tendon	70x25	75x30	110x35	125x45

TABLE 6.1A Continued
FRL - REQUIREMENTS FOR STRUCTURAL ADEQUACY CRITERION

BUILDING ELEMENT	FRL (minutes)			
	30	60	90	120
Beams min. width of web (mm) x clear cover (mm)				
Simply supported -				
. reinforcement	75x20	120x30 or 150x25 or 240x20	150x45 or 200x35 or 300x30 or 500x25	200x55 or 240x45 or 360x40 or 600x33
. tendon	75x25	120x35 or 150x30 or 240x25	150x55 or 200x45 or 300x40 or 600x35	200x65 or 240x55 or 360x50 or 600x43
Continuous -				
. reinforcement	75x20	120x20	150x25 or 200x20	200x35 or 240x25 or 380x20
. tendon	75x25	120x25	150x35 or 200x30	200x45 or 240x35 or 380x30
Vertical Walls clear cover in mm				
. to reinforcement	20	20	35	40
. to tendons	30	30	30	30
Note:- Vertical walls must also satisfy the requirements of Table 6.1B				
Columns min. cross-sectional dimension (mm) x clear cover (mm)				
. to reinforcement	150x10	200x20 or 240x15	250x35 or 300x25	300x45 or 400x35

TABLE 6.1 B
MAXIMUM ALLOWABLE SLENDERNESS RATIO FOR CONCRETE WALLS

Ratio of design axial force to the product of gross cross-sectional area and the characteristic compressive cylinder strength at 28 days	Corresponding maximum value of slenderness ratio (effective height/thickness)
0.0	50
0.005	35
0.03	20
0.10	15

Notes:

1. Values in between can be interpolated.
2. Design axial force = 1.1 dead load + 0.6 live load including impact.
3. The characteristic compressive strength in MPa is generally expressed as the grade of the concrete.

TABLE 6.3
MINIMUM EFFECTIVE THICKNESS FOR INSULATION

FRL for insulation criterion minute	Effective thickness mm
30	60
60	80
90	100
120	120

**7. GYPSUM-PERLITE OR GYPSUM-VERMICULITE
PLASTER ON METAL LATH**

7.1 Walls

In walls fabricated of gypsum-perlite or gypsum-vermiculite plaster on metal lath and channel -

- (a) the lath must be securely wired to each side of 19 mm x 0.44 kg/m steel channels (used as studs) spaced at not more than 400 mm centres; and
- (b) the gypsum-perlite or gypsum-vermiculite plaster must be applied symmetrically to each exposed side of the lath.

7.2 Columns

For the fire protection of steel columns with gypsum-perlite or gypsum-vermiculite on metal lath -

- (a) the thickness of the plaster must be measured from the back of the lath;

- (b) the lath must be fixed at not more than 600 mm centres vertically to steel furring channels, and -

- (i) if the plaster is to be 35 mm thick or more - at least 12 mm clear of the column; or
- (ii) if the plaster is to be less than 35 mm thick - at least 6 mm clear of the column; or

- (c) the plaster may be applied to self-furring lath with furring dimples to hold it not less than 10 mm clear of the column.

7.3 Beams

For the fire protection of steel beams with gypsum-perlite or gypsum-vermiculite on metal lath -

- (a) the lath must be fixed at not more than 600 mm centres to steel furring channels and at least 20 mm clear of the steel;
- (b) the thickness of the plaster must be measured from the back of the lath.

A2.3 FIRE-RESISTANCE OF BUILDING ELEMENTS

8. EXPOSURE OF COLUMNS AND BEAMS

8.1 Columns

A column incorporated in or in contact on one or more sides with a wall of solid masonry or concrete at least 100 mm thick may be considered to be exposed to fire on no more than 3 sides.

8.2 Beams

A beam, open-web joist, girder or truss in direct and continuous contact with a concrete slab or a hollow block floor or roof may be considered to be exposed to fire on no more than 3 sides

9. FILLING OF COLUMN SPACES

If steel columns are deemed to have FRLs of more than 120/-, the spaces between the fire-protective material and the steel (and any re-entrant parts of the column itself) must be filled solid with a fire-protective material like concrete or grout.

10. REINFORCEMENT FOR COLUMN AND BEAM PROTECTION

10.1 Masonry

Concrete masonry for the protection of steel columns must have steel-wire or mesh reinforcement in every second course and lapped at the corners.

10.2 Structural concrete

If a steel column or a steel beam is to be protected with structural concrete -

- (a) the concrete must be reinforced with steel-wire mesh or steel-wire binding placed about 20 mm from its outer surface; and
- (b) for concrete less than 50 mm thick, the steel wire must be -
 - (i) at least 3.15 mm in diameter; and
 - (ii) spaced at not more than 100 mm vertically; or
- (c) for concrete not less than 50 mm thick, the steel wire must be either -
 - (i) of a diameter and spacing in accordance with (b); or
 - (ii) at least 5 mm in diameter and spaced at not more than 150 mm vertically.

10.3 Gypsum-perlite or gypsum-vermiculite plaster sprayed to contour

- (a) If a steel column or steel beam is protected with either gypsum-perlite or gypsum-vermiculite plaster sprayed to contour and the construction falls within the limits of Table 10.3, the plaster must be reinforced with -
 - (i) expanded metal lath complying with Clause 1.4; or
 - (ii) galvanised steel mesh complying with Clause 1.4.
- (b) The reinforcement must be placed at a distance from the face of the plaster of at least 1/3 of the thickness of the plaster and must be securely fixed to the column or beam at intervals of not more than the relevant listing in Table 10.3.
- (c) For the purposes of Table 10.3 -
 - (i) "vertical" includes a surface at not more than 10° to the vertical;
 - (ii) "horizontal" includes a surface at not more than 10° to the horizontal; and
 - (iii) "underside" means the underside of any horizontal or non-vertical surface.

11 THICKNESS OF COLUMN AND BEAM PROTECTION

11.1 Measurement of thickness

The thickness of the fire-protection to steel columns and steel beams (other than fire protection of gypsum-perlite or gypsum-vermiculite plaster sprayed on metal lath or sprayed to contour) is to be measured from the face or edge of the steel, from the face of a splice plate or from the outer part of rivet or bolt, whichever is the closest to the outside of the fire-protective construction, except that-

- (a) if the thickness of the fire-protection is 40 mm or more, rivet heads may be disregarded; and
- (b) if the thickness of the fire-protection is 50 mm or more -
 - (i) any part of a bolt (other than a high-tensile bolt) may be disregarded; and
 - (ii) a column splice plate within 900 mm of the floor may encroach upon the fire protection by up to a 1/4 of the thickness of the fire protection;

**TABLE 10.3
REINFORCEMENT OF GYPSUM-PERLITE OR GYPSUM-VERMICULITE
PLASTER SPRAYED TO CONTOUR**

SURFACE TO BE PROTECTED	REINFORCEMENT REQUIRED IF SMALLER DIMENSION OF SURFACE EXCEEDS (mm)	MAX SPACING OF FIXINGS OF THE MESH TO SURFACE (mm)
Members with H or I cross-section:		
Vertical-	450	450
Non-vertical-	300	300
Underside-	300	300
Upperside of a horizontal surface-	Not required	
Members with other shapes		
Vertical	Any size	450
Non-vertical-	Any size	300
Upperside of a horizontal surface-	Not required	

EARLY FIRE HAZARD TEST FOR ASSEMBLIES

1. Scope

This Specification sets out the procedures for determining the Early Fire Hazard Indices of components and assemblies. These tests classify building materials, their surface finishes and furnishings according to:-

- (a) their tendencies to ignite;
- (b) their tendencies to spread flame;
- (c) the heat they develop once ignition has occurred; and
- (d) their tendencies to produce smoke.

2. Form of test

Tests must be carried out in accordance with AS 1530.3 and AS 1530.4.

3. Test specimens

Test specimens must incorporate -

- (a) all types of joints; and

- (b) all types of perforations, recesses or the like for pipes, light switches or other fittings, which are proposed to be used for the member or assembly of members in the building.

4. Concession

Clause 3 does not apply to joints, perforations, recesses or the like that are larger than those in the proposed application and have already been tested in the particular form of construction concerned and found to comply with the conditions of test.

5. Smaller specimen permitted

A testing laboratory may carry out the test at pilot scale if a specimen (which must be not less than 900 mm) will adequately represent the proposed construction in the building, but the results of that test do not apply to construction larger than limits defined by the laboratory conducting the pilot examination.

**NATIONAL
BUILDING
CODE
1990**

ALL BUILDINGS

SECTION B

STRUCTURE

**Performance Requirements
Deemed-to-Satisfy Provisions**

B1 Structural Provisions

B2 Demolition

1
2
3
4
5
6
7
8
9
10
11
12
13
14
15
16
17
18
19
20
21
22
23
24
25
26
27
28
29
30
31
32
33
34
35
36
37
38
39
40
41
42
43
44
45
46
47
48
49
50
51
52
53
54
55
56
57
58
59
60
61
62
63
64
65
66
67
68
69
70
71
72
73
74
75
76
77
78
79
80
81
82
83
84
85
86
87
88
89
90
91
92
93
94
95
96
97
98
99
100

SECTION B

THIS SECTION APPLIES TO ALL BUILDINGS

CONTENTS

PERFORMANCE REQUIREMENTS

DEEMED-TO-SATISFY PROVISIONS

Part		Part	
B1	Structural Provisions	B2	Demolition
B1.1	General requirements	B2.1	General requirements
B1.2	Loads	B2.2	Applicable standard
B1.3	Construction deemed-to-satisfy	B2.3	Dangerous buildings
B1.4	Human impact against glazing		

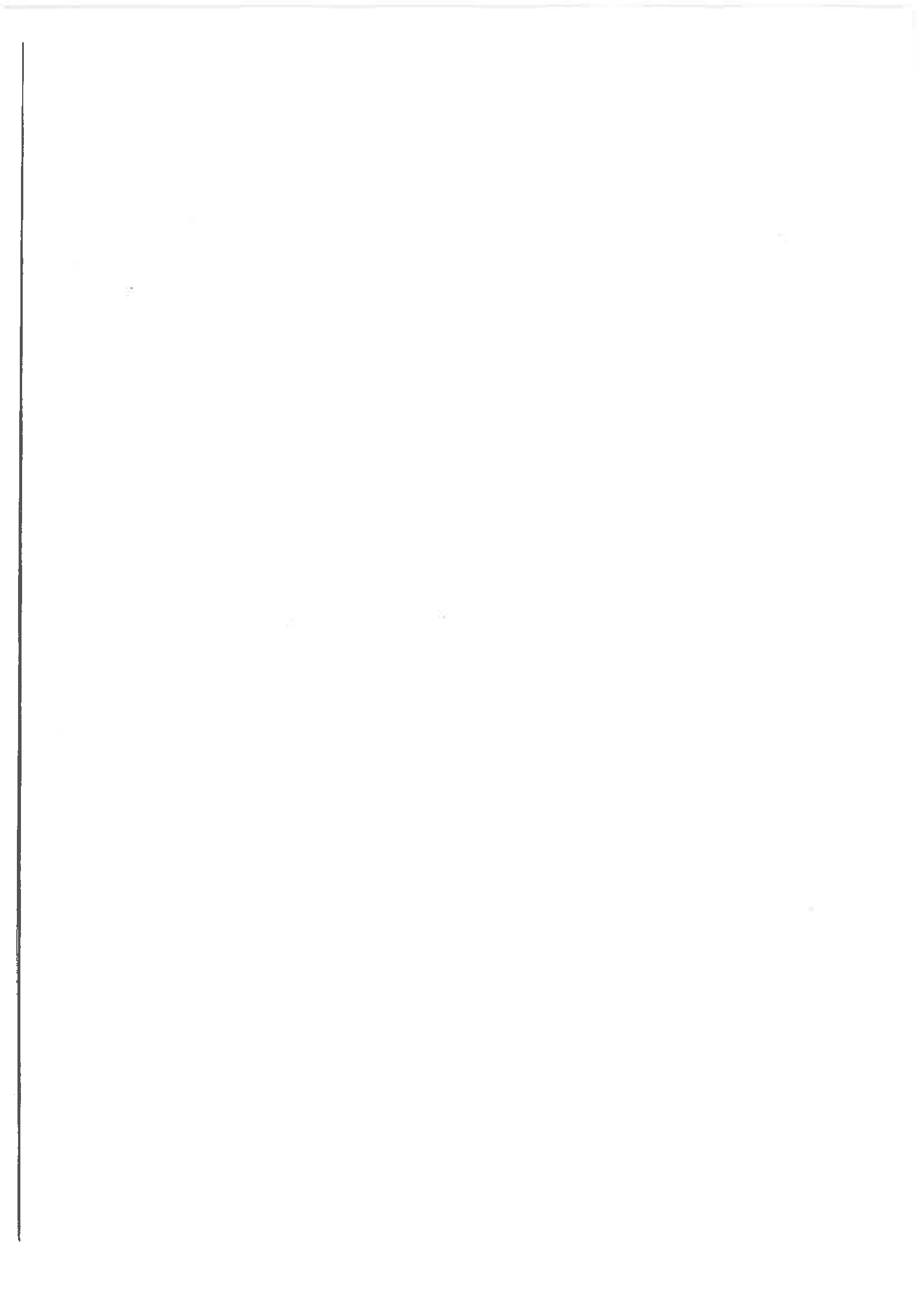

PERFORMANCE REQUIREMENTS

OBJECTIVES

BP1 A building and all connected services must be designed and constructed to fulfil the following objectives:-

- (a) prevent death and injury to people from structural failure
- (b) avoid distress to occupants as a result of deflection vibration degradation or other similar causes
- (c) avoid damage to neighbouring property
- (d) the building must satisfy the intended use

BP2 Procedures and methods of demolition must be adequate to prevent death and injury to persons and avoid damage to neighbouring property.

- (h) impact
- (i) explosion/implosion
- (j) fire
- (k) water and other liquids
- (l) fatigue resulting from fluctuating loads
- (m) differential displacement
- (n) adverse effects due to closeness of other buildings
- (o) any other expected loads.

REQUIRED PERFORMANCE

BP1.1 Design loads

Buildings and their elements must be designed and constructed in order to prevent structural failure during the expected life of the building and to avoid unacceptable deflections and vibrations during the normal use of the building, resulting from -

- (a) combinations and frequency of all possible loads, dynamic responses and internal actions;
- (b) the properties of the materials used in the building; and
- (c) the foundation conditions.

BP1.1.1 The design and construction must take into account the loads resulting from the following acting either singly or in possible combinations -

- (a) self weight
- (b) imposed loads
- (c) temperature variations
- (d) earth pressure
- (e) wind
- (f) earthquake
- (g) resonance effects

BP1.1.2 The design and construction must allow for -

- (a) the consequences of failure;
- (b) the quality of workmanship available;
- (c) variations in material properties and site characteristics; and
- (d) want of accuracy in the methods used to predict the structural performance of the building.

BP1.2 Site works

- (a) Site works as necessary must be carried out to ensure the stability of the building site during the expected life of the building.
- (b) While carrying out site works any damage to existing structures or adjacent property must be avoided.
- (c) Alterations to the ground water level resulting from site works must not be allowed to affect the stability of any building.

BP1.3 Design criteria

The following criteria must be satisfied -

- (a) during the designed life of the building the probability of experiencing unacceptable deflections or vibrations must not exceed 5%;
- (b) the probability of risk of structural failure must not exceed 0.1% within the designed life of the building;

B STRUCTURE

BP2.1 Demolition of buildings

While buildings are demolished the following must be ensured -

- (a) safety of the public and of the site personnel from injury or death;
- (b) avoidance of damage and nuisance from dust, vibrations, noise, water, fire, smoke and fumes;
- (c) continued access to other properties;
- (d) the exhibition of appropriate notices warning the public; and
- (e) prevention of damage to public services such as water and sewerage pipes, electricity and telephone lines etc and allow their continued use.

BP2.1.1 Design and planning of demolition

The method and sequence of demolition must be planned in detail with due allowance for the following -

- (a) the sudden release of locked up forces such as with prestressed concrete, arches, cantilevers etc;

- (b) the height of the structure;
- (c) clear space available;
- (d) the presence of dangerous or inflammable materials such as gas cylinders, aerosol spray cans, drums containing flammable material or explosive dusts, foam plastics etc;
- (e) the structural condition of the building;
- (f) the presence of basements, cellars, vaults and other voids and if so the effect of removal of cross walls and the like;
- (g) the requirement for any cutting, welding or burning;
- (h) the requirement for temporary supports, shoring scaffolding and the like and the loads including impact loads that they may have to take;
- (i) the loads from the stationing and operation of demolition equipment especially if supported on parts of the building being demolished; and
- (j) any other likely factors.

DEEMED-TO-SATISFY PROVISIONS

STRUCTURAL PROVISIONS

B1.1 General requirements

Materials, components and methods of construction used in a building or structure and all attached services must be capable of sustaining at an acceptable level of safety and serviceability -

- (a) the most adverse combinations of loads (including combinations of loads that might result in a potential for progressive collapse); and
- (b) other actions

to which they may reasonably be subjected.

B1.2 Loads

The loading requirements of B1.1 are satisfied if the building or structure can resist loads determined in accordance with the following:

(a) Wind loads:

AS1170 Minimum design loads on structures (known as SAA Loading Code)

Part 2 - Wind loads

When using Part 2 of the Standard the following provisions apply:

a limit state basic wind speed of 70 m/s to all areas. The equivalent basic wind speed for permissible stress methods of design is 57 m/s. When the simplified procedure of AS 1170 part 2 is followed, the value of the factor B_1 to be applied is 2.3. The map of Australia at Figure 2.5.1 and 3.2.2 in the Standard are to be disregarded.

(b) Dead, Live and earthquake loads:

NZS4203 Part 1, 2 and 3 General structural design and design loadings for buildings.

The maps of New Zealand shown in the Standard are to be disregarded. The earthquake zones for Fiji are marked in Figure B1.2. For use with NZS 4203 the zone factors corresponding to the zone numbers given in the figure are:-

ZONE NO.	ZONE FACTOR
4	0.4
6	0.6
7	0.7

Each zone factor applies uniformly over the whole area of the zone.

Note: The zone numbers have been given on the basis of consistent values for Fiji, Vanuatu, Solomon Islands, Cook Islands, Tuvalu and Niue. This means that any particular zone number such as zone 6 and the value of its zone factor, have the same meaning in the codes of all of these countries.

- (c) **Other loads:** The principles of structural mechanics.

B1.3 Construction deemed-to-satisfy

The requirements of B1.1 for materials and forms of construction are satisfied if they comply with the following:

(a) Masonry

- (i) Code of practice for masonry buildings, materials and workmanship: NZS 4210
- (ii) Code of practice for masonry buildings not requiring specific design: NZS 4229
- (iii) Code of practice for design of masonry structures: NZS 4230

(b) Concrete

- (i) The design of concrete structures: NZS 3101 Parts 1 and 2
- (ii) Specification for concrete construction: NZS 3109
- (iii) Specification for concrete construction for minor works: NZS 3124

(c) Steel construction- NZS 3404.

(d) Aluminium construction: AS 1664.

(e) Timber construction - Design of timber structures: AS 1720 or NZS 3603.

(f) Footings: Footings for Class 1 and 10a buildings: AS 2870.1.

(g) Piling: AS 2159.

(h) Glass installations: NZS 4223 subject to B1.4.

(i) Protection from termites: In areas subject to infestation by subterranean termites:

- (i) Physical barriers: AS 1694.
- (ii) Soil treatment: AS 2057.

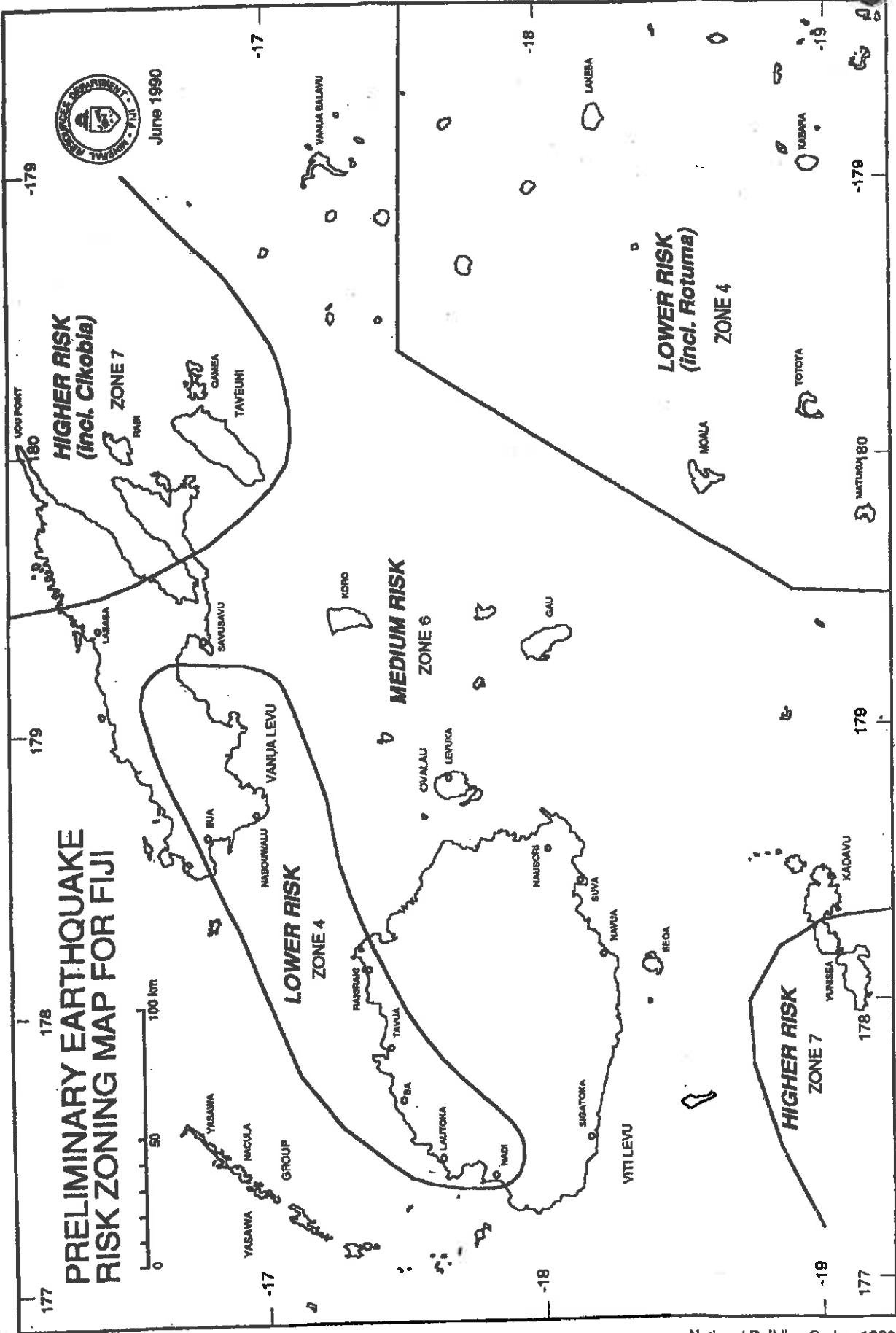

FIGURE B1.2

- (j) **Roof construction:** TR 440 and manufacturer's recommendations.
 - (k) **Particleboard structural flooring:** AS 1860.
 - (l) **External wall cladding:** No structural damage when tested to TR 440 to withstand impact from a 4 kg piece of timber of nominal cross-section 100 mm x 50 mm striking end on at a velocity of 15 m/s.
- B1.4 Human impact against glazing**
- (a) Glazing of windows and other openings and their support systems designed only against wind loads are not safe against human impact. In order to provide for reasonable safety against injury or death resulting from glass breakage and possible falls, glazing and its support framing must be designed for the levels of risk shown in Table B1.4. The impact energy that the glass and its framing must resist for different levels of risk and for different configurations of glazing are given in Figure B1.4.
 - (b) The following must be taken into account while designing glazing against human impact -
 - (i) laminated glass and toughened glass are considered to be safety glass in terms of injury potential from fragments and splinters. Wired glass and heat-strengthened glass are not safety glasses.
 - (ii) annealed or laminated glass which has minor abrasion damage or has been sand blasted on the tension face has its impact strength severely reduced.
 - (iii) the strength of glass can be substantially reduced by the lapse of time.
 - (c) The barrier protection shown in Figure B1.4 must be designed to NZS 4203. The deflection of the barrier must not exceed 50% of the distance between the hand rail and the glass when a concentrated force of 1.2 kN is applied to the face of the barrier.

**TABLE B 1.4
RISK LEVEL FOR CLASS OF BUILDING FOR ASSESSMENT OF REQUIRED STRENGTH OF GLAZING**

HEIGHT OF FALL IN CASE OF GLAZING FAILURE	RISK		
	HIGH	MEDIUM	LOW
more than 6 m	2, 6, 9b	3, 4, 5, 7, 8, 9a	-
3 m to 6 m	-	2, 6, 9b	3, 4, 5, 7, 8, 9a
up to and including 3 m	-	6, 9b	2, 3, 4, 5, 7, 8, 9a

GLAZING CONFIGURATION

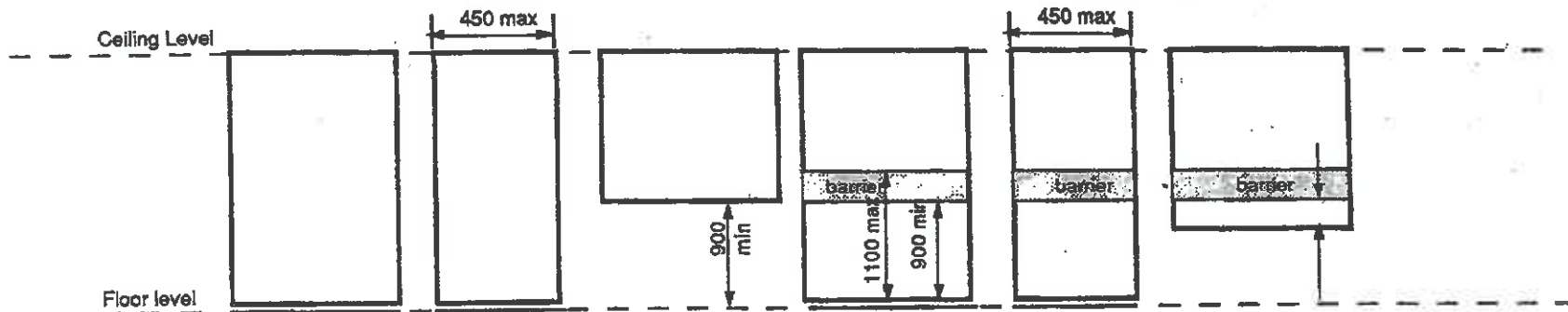

RISK LEVELS						
High	600 Joules for containment Note 2	425 Joules for containment Note 2	Note 1	425 Joules for containment Note 2	250 Joules for containment Note 2	Note 2 breaksafe Note 3
Medium	425 Joules for containment Note 2	250 Joules for containment Note 2	Note 1	250 Joules for containment Note 2	Note 1	Note 1
Low	250 Joules for containment Note 2	150 Joules for containment Note 2	Note 1	150 Joules for containment Note 2	Note 1	Note 1

Notes:

- 1) No specific impact requirement. Select glass as per NZS 4223.
- 2) Containment - fracture of glass gives no significant penetration eg. laminated glass. Containment *required* for impacts up to and including level set.
- 3) Breaksafe - fracture of glass gives either relatively harmless pieces or insufficient penetration to cause injury eg. laminated or toughened glass.
- 4) All dimensions in millimetres.

FIGURE B1.4 CAPACITY REQUIRED OF GLAZING ELEMENTS AGAINST HUMAN IMPACT

DEMOLITION

B2.1 General requirements

All dangerous buildings as detailed in B2.3 must either be restored to *required* standards or be demolished. The planning and execution of demolition must:

- (a) not put at risk the safety and health of the public and of the workers;
- (b) avoid damage to other properties;
- (c) avoid nuisance to others;
- (d) allow continued access to other properties; and
- (e) prevent damage to public services and allow continued operation of such services.

B2.2 Applicable Standard

The requirements of B2.1 are satisfied if demolition is carried out to AS 2601 - The demolition of structures.

B2.3 Dangerous buildings

Any building which has any of the conditions or defects described below must be deemed to be a dangerous building, if such conditions or defects exist to the extent that the life, health, safety or property of the public or its occupants are endangered whenever:

- (a) any *required exit* is not of sufficient width or size or is not so arranged as to provide safe and adequate means of egress in case of fire or other emergency;
- (b) the stress in any materials or member due to all applicable loads, is more than 1.5 times the working stress or stresses allowed for new buildings of similar class and type of construction;
- (c) any portion of the building has been damaged by fire, earthquake, wind, flood or by any other cause, to such an extent that its structural strength or stability is materially less than it was before such catastrophe and is less by 33 percent or more than the minimum requirements for new buildings of similar class and type of construction;
- (d) any portion or member or attachment of the building is likely to fail, or to become detached or dislodged, or to collapse and thereby injure persons or damage property;
- (e) any portion of the building has suffered distortion, cracking or settlement to such an extent that walls or other structural portions have materially less resistance to winds or earthquakes than is *required* in the case of similar new construction;
- (f) the building or any portion of it is likely to collapse or fail to perform the intended function, as a result of:
 - (i) dilapidation, deterioration or decay;
 - (ii) faulty construction;
 - (iii) the removal, movement or instability of any portion of the ground necessary for the purpose of supporting such building;
 - (iv) the deterioration, decay or inadequacy of its foundation; or
 - (v) any other cause;
- (g) the building exclusive of the foundation, shows 33 percent or more damage or deterioration of any supporting member or 50 percent damage or deterioration of its nonsupporting members;
- (h) any building has in any nonsupporting part, member or portion less than 50 percent, or in any supporting part, member or portion less than 66 percent of the
 - (i) strength, or
 - (ii) *fire-resisting* requirements; and
- (i) a building because of inadequate maintenance, dilapidation, decay, damage, faulty construction or arrangement, inadequate light, air or sanitation facilities, or otherwise, is likely to cause sickness or disease.

**NATIONAL
BUILDING
CODE
1990**

DWELLINGS AND OUTBUILDINGS (CLASS 1 AND 10)

SECTION DC

FIRE RESISTANCE

**Performance Requirements
Deemed-to-Satisfy Provisions**

DC1 Fire Resistance and Stability

CONTENTS

PERFORMANCE REQUIREMENTS

DEEMED-TO-SATISFY PROVISIONS

Part		Part	
DC1	Fire Resistance and Stability		
DC1.1	External walls of Class 1 buildings	DC1.5	Exceptions
DC1.2	Class 1 buildings: Construction of external walls	DC1.6	Common walls
DC1.3	Class 10a buildings: External walls	DC1.7	Separating floors
DC1.4	Allowable encroachments	DC1.8	Sarking-type materials

PERFORMANCE REQUIREMENTS

OBJECTIVES

DCP1 A Class 1 or Class 10 building must be so designed and constructed that the following objectives are fulfilled:

- (a) it is protected from fire in any other building; and
- (b) materials used in the construction be such that if there is a fire in the building-
 - (i) the spread of fire and the generation of smoke and toxic gases will be minimised;
 - (ii) stability will be maintained for a period at least sufficient for the occupants to escape and to ensure the safety of fire-fighters; and
 - (iii) there will be little risk of collapse onto adjoining property.

REQUIRED PERFORMANCE

DCP1.1 *External walls* of Class 1 buildings, located within 1.5 m of the allotment boundary or 3 m from other buildings than of Class 10 (a) on the same allotment must -

- (a) remain stable and not allow the passage of destructive heat, flames, smoke or gases through them for an hour, in the event of a fire; and

- (b) not allow the passage of flames, smoke or gases through *windows* for an hour and such *windows* must not be openable.

DCP1.2 The *external wall* of a Class 10 (a) building which is less than 1 m away from the allotment boundary other than with a road alignment or public space must not be *combustible*.

DCP1.3 A *common wall* must -

- (a) if it separates a Class 1 building from any Class other than 10 (a), remain stable and prevent the passage of destructive heat, flames, smoke or gases for an hour, in the event of a fire;
- (b) if it separates a Class 1 building from a Class 10 (a) building on different allotment be not *combustible*.

DCP1.4 The underside of a floor separating 2 *sole-occupancy units* each being a separate domicile must not be *combustible*.

DCP1.5 Any *sarking-type material* used in a Class 1 building must have a *flammability index* of less than 5.



DEEMED-TO-SATISFY PROVISIONS

FIRE RESISTANCE AND STABILITY

DC1.1 External walls of Class 1 buildings

Except as permitted by Clause DC1.4 or DC1.5, an *external wall* of a Class 1 building, and any openings in that wall, must comply with clause DC1.2 if-

- (a) the wall is set back less than 1.5 m from an allotment boundary other than the boundary adjoining a road alignment or other public space; or
- (b) the wall is less than 3.0 m from another building on the same allotment other than a Class 10 building.

DC1.2 Class 1 buildings: Construction of external walls

- (a) *External walls* referred to in Clause DC1.1 must have a FRL of not less than 60/60/60.
- (b) Openings in *external walls* referred to in Clause DC1.1 must-
 - (i) be protected with fire *windows* or glass block or other construction with a FRL of at least - /60/- ; and
 - (ii) not be fitted with openable *windows*.

DC1.3 Class 10a buildings: External walls

An *external wall* of a Class 10a building other than an *open garage* must be of *non-combustible* construction or lined externally with *non-combustible* material if it is set back less than 1.5 m from the allotment boundary other than with a road alignment or public space.

DC1.4 Allowable encroachments

The distance from an allotment boundary or between buildings must be the shortest distance measured from the outermost point of the building or buildings concerned, except that-

- (a) fascia, gutters, downpipes, *non-combustible* eaves lining, and the like;
- (b) masonry chimney backs, flues, pipes, cooling or heating appliances or other services;
- (c) light fittings, electricity or gas meters, aerials or antennae;

(d) pergolas or sun blinds; and

(e) unroofed terraces, landings, steps or ramps, not more than 1 m in height,

may encroach into that distance if thereby the distance to the boundary is not reduced to less than 1 m nor the distance between the buildings to less than 1.5 m.

DC1.5 Exceptions

Clause DC1.1 does not apply to-

- (a) an *external wall* that previously complied with this Part and is reclad, if the recladding does not reduce the distance to the boundary or building by more than 150 mm; or
- (b) an *open garage*.

DC1.6 Common walls

A *common wall* must-

- (a) be of masonry or concrete, or be fully lined with *fire-protective covering* and extend to the underside of a *non-combustible* roof or not less than 450 mm above a roof with a *combustible* lining;
- (b) have a FRL of not less than 60/60/60 if it separates Class 1 buildings, or a Class 1 building and a Class 10 (a) building, on different allotments; or
- (c) be lined with a *non-combustible* material if it separates Class 10a buildings on different allotments.

DC1.7 Separating floors

The underside of a floor separating *sole-occupancy units*, each being a separate domicile and located one above the other, must be lined with material with a FRL of not less than 30/30/30.

DC1.8 Sarking-type materials

Any *sarking-type material* used in a Class 1 building must have a *Flammability Index* of not more than 5.

**NATIONAL
BUILDING
CODE
1990**

DWELLINGS AND OUTBUILDINGS (CLASS 1 AND 10)

SECTION DD

ACCESS AND EGRESS

**Performance Requirements
Deemed-to-Satisfy Provisions**

DD1 Construction of Exits

CONTENTS

PERFORMANCE REQUIREMENTS

DEEMED-TO-SATISFY PROVISIONS

Part

DD1 Construction of Exits

DD1.1 Treads and risers

DD1.2 Curved stairs

DD1.3 Balustrades

Part

DD1.4 Parapets on flat roofs

DD1.5 Number of exits

DD1.6 Ramp in exits

DD1.7 Dimensions of exits

PERFORMANCE REQUIREMENTS

OBJECTIVES AND REQUIRED PERFORMANCE

DDP 1 A Class 1 or 10 (a) building must be so designed and constructed that the following are fulfilled:

- (a) Stairways, ramps and passageways must be such as to provide safe passage for the users of the building.
- (b) Stairways, ramps, floors and balconies, and any roof to which people normally have access, must have bounding walls, balustrades or other barriers

where necessary to protect users from the risk of falling.

- (c) Stairways must provide safe and reasonably comfortable dimensions for goings and risers. In any case the *pitch* of the stairway must be maintained within limits of 23° and 42°.
- (d) If any ramp is used the slope must not exceed 1:8.
- (e) A Class 1 building must have provision for fast exit during any emergency.

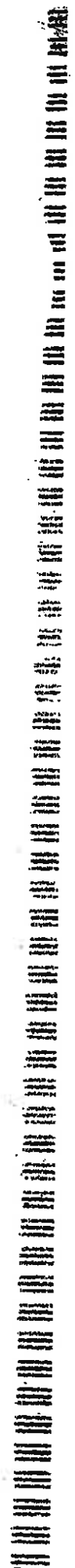

DEEMED-TO-SATISFY PROVISIONS

CONSTRUCTION OF EXITS

DD1.1 Treads and risers

- (a) A stairway must be suitable to provide safe passage in relation to the nature, volume and frequency of likely usage.
- (b) A stairway in any building satisfies (a) if it has:
- (i) not more than 18 risers in each flight;
 - (ii) going and riser dimensions in accordance with Figure DD1.1 and Table DD1.1 that are constant throughout each flight;
 - (iii) risers which do not have any openings that would allow a 100 mm sphere to pass through between the treads;
 - (iv) treads which have a non-slip finish or a suitable non-skid strip near the edge of the nosings;
 - (v) treads of solid construction (not mesh or other perforated material) if the stairway connects more than 3 storeys; and
 - (vi) the tread must not exceed the going by more than 20 mm.

DD1.2 Curved stairs

Curved stairs must comply with the relevant requirements of DD1.1 as well as the following:

- (a) For the purposes of satisfying Table DD1.1 the going must be measured:
- (i) along half way across the width of the stair where the clear width is less than 900 mm; and
 - (ii) 300 mm from each side of the stair where the clear width is 900 mm or more.
- (b) All steps must have the same uniform taper.
- (c) The going at the narrow end of the steps must be not less than 75 mm.
- (d) Winders are not permitted.

DD1.3 Balustrades

- (a) A continuous balustrade must be provided along the side of any stairway or ramp, or any corridor, hallway, balcony, bridge or the like, if
- (i) it is not bounded by a wall; and
 - (ii) the change in level is more than 1 m.

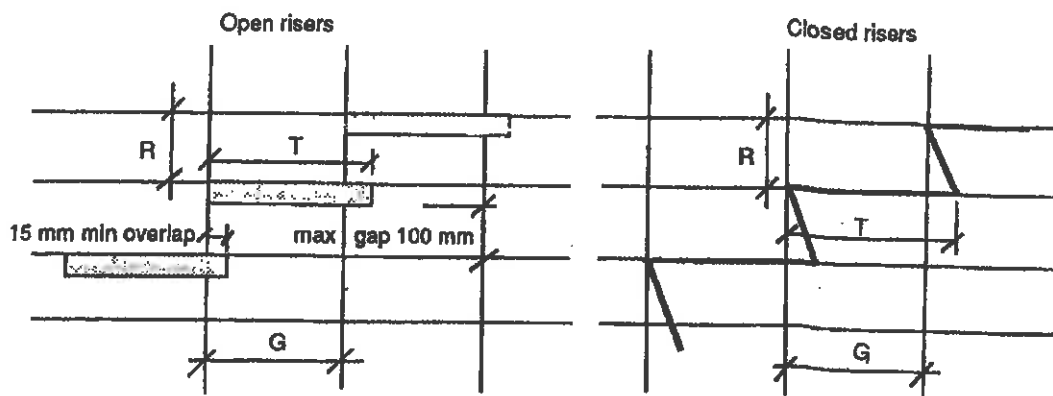

Note: R = Riser
G = Going
T = Tread

FIGURE DD1.1 MEASUREMENT OF RISER GOING AND TREAD

**TABLE DD1.1
RISER DIMENSIONS (mm) TO MATCH GOING**

Pitch	GOING (mm)											
	230	240	250	260	270	280	290	300	310	320	330	
42°												
41°	200											
40°	192	200										
39°	186	194	200									
38°	180	187	195	200								
37°	173	181	188	196	200							
36°	167	174	182	188	196	200						
35°	161	168	175	182	189	195	200					
34°	155	162	168	175	182	188	195	200				
33°	149	156	162	169	175	181	188	195	200			
32°		144	156	162	168	174	181	187	194	200		
31°			150	158	162	167	174	180	186	192	198	
30°				150	156	161	167	173	179	185	190	
29°					150	155	161	167	173	179	183	
28°						150	155	160	165	170	175	
27°							148	153	158	163	168	
26°								146	151	156	161	
25°										149	154	
24°												147

Note:
Actual riser dimension may be selected to suit the inter landing height. However the value of the riser dimension must not be outside the maximum or minimum dimensions shown for each value of going.

- (b) A balustrade must prevent, as far as practicable-
 - (i) children climbing over or through it;
 - (ii) persons accidentally falling from the floor; and
 - (iii) objects which might strike a person at a lower level accidentally falling from the floor surface.
- (c) At balconies a balustrade satisfies (b) if -
 - (i) it has a height of not less than 930 mm above the balcony floor;
 - (ii) the space between balusters or the width of any opening in the balustrade is not more than 100 mm except where the space between the rails or the height of the opening is not more than 100 mm;
- (iii) all parts of the balustrade more than 150 mm and less than 760 mm from the floor or nosings are vertical or otherwise do not provide a toe-hold; and
- (iv) it does not have any openings more than 100 mm wide within 150 mm of the floor level.
- (d) In stairways and ramps (including access bridges and landings) a balustrade satisfies (b) if -
 - (i) it has a height of not less than 865 mm above the nosings of the stair treads and the floor of the landing, balcony, corridor, hallway, access bridge or the like;
 - (ii) the space between balusters or the width of any opening in the balustrade (including any openable window or panel) is not more than 100 mm except where the space between rails or the height of the opening is not more than 100 mm; and

- (iii) all parts of the balustrade more than 150 mm and less than 760 mm from the floor or nosings are vertical or otherwise do not provide a toe-hold.

DD 1.4 Parapets on flat roofs

Where a flat roof or other elevated place has regular access a parapet or balustrade of not less than 1 m height above the surface of the roof or elevated place must be provided. The width of any opening in the parapet or balustrade must not exceed 100 mm.

DD1.5 Number of exits

Every Class 1 building must have two exits. At least one of these exits must provide an easy means of egress in case of any emergency without reducing security to the building. Such emergency exits may take the form of a trap door on

an elevated floor or some such arrangement. Windows and other such openings used as emergency exits must have a minimum clear dimension of 560 mm and a minimum clear area of opening of 0.6 m². The shutter must be capable of opening to 90° to the wall. The top of the window sill must be no more than 900 mm from the floor inside. The height of the window sill from the ground or floor outside must not exceed 1800 mm.

DD1.6 Ramp in exits

A ramp may be used in place of a stairway. The gradient of any such ramp must be no steeper than 1:8.

DD1.7 Dimensions of exits

The clear minimum width of a stairway or ramp must be 760 mm. The unobstructed height throughout must be not less than 2 m.

**NATIONAL
BUILDING
CODE
1990**

DWELLINGS AND OUTBUILDINGS (CLASS 1 AND 10)

SECTION DE

ELECTRICITY

**Performance Requirements
Deemed-to-Satisfy Provisions**

DE1 Electrical Safety

DE2 Amenity

CONTENTS

PERFORMANCE REQUIREMENTS

DEEMED-TO-SATISFY PROVISIONS

Part

DE1 Electrical Safety

DE1.1 General Requirement

DE1.2 Plug Sockets

Part

DE2 Amenity

DE2.1 Light switch layout

PERFORMANCE REQUIREMENTS

OBJECTIVES

All electrical work associated with a Class 1 or 10 building must meet the following objectives

DEP1 Electrical Safety

It must prevent electrocution, burns or fire.

DEP2 Amenity

It must satisfy the reasonable expectations of the occupants by ensuring that it is adequate for their intended use, both current and anticipated.

REQUIRED REFORMANCE

DEP1.1 Electrical safety

The supply system must:

- (a) have suitable devices of adequate interruptive duty to automatically shut off the supply in the event of a fault or overload. Such devices must allow easy reinstatement of the supply after interruption;

- (b) have devices which are clearly identified and easily reached to isolate live parts from the incoming supply;
- (c) when the neutral of the supply is earthed, have socket outlet or plug - socket adaptor construction which would ensure that the live, neutral and earth conductors can only be connected to the corresponding live, neutral and earth conductors of the plug;
- (d) be adequately protected against damage arising from exposure to weather, water or excessive dampness mechanical loads and other such agents expected under normal conditions of use; and
- (e) ensure that the main switch is normally accessible only to the occupants.

DEP2.1 Amenity

The supply system must have an adequate number of plug sockets of minimum 10 Amperes capacity to serve the reasonable anticipated needs of the occupants.



DEEMED-TO-SATISFY PROVISIONS**ELECTRICAL SAFETY****DE1.1 General requirements**

All electrical wiring and installations in or on any class 1 and 10 building must ensure safety from electric shock and fire. This requirement is satisfied if all electrical work associated with the building is done to comply with AS 3000 - Electrical Installations - buildings, structures and premises (known as the SAA Wiring Rules). The capacity of the system must allow for the long term anticipated requirements of the occupants.

- (b) be located so that
 - (i) cords need not be taken across doorways;
 - (ii) trailing cords do not have to cross circulation routes;
- (c) not be located behind door-swings; and
- (d) in the kitchen be located 250 mm above worktops at the back of benches or on a return wall where it exists.

DE1.2 Plug sockets

Plug sockets must:

- (a) have their individual switch;

AMENITY

DE2.1 Light switch layout

The layout of light switches must follow the main night time circulation routes such as from the entrance hall to the living area to the bed-rooms to the bathroom and toilet. Crossing any major space in the dark must be avoided. The switches must be located close to door openings.

**NATIONAL
BUILDING
CODE
1990**

DWELLINGS AND OUTBUILDINGS (CLASS 1 AND 10)

SECTION DF

HEALTH AND AMENITY

**Performance Requirements
Deemed-to-Satisfy Provisions**

- DF1 Damp and Weatherproofing**
- DF2 Cooking and Sanitary Facilities**
- DF3 Room Sizes and Heights**
- DF4 Light and Ventilation**
- DF5 Watersupply Plumbing**
- DF6 Sanitary Plumbing and Drainage**
- DF7 Roof Drainage**

CONTENTS

PERFORMANCE REQUIREMENTS

DEEMED-TO-SATISFY PROVISIONS

Part	Part
DF1 Damp and Weatherproofing	DF5 Watersupply Plumbing
DF1.1 Site drainage	DF5.1 General requirements
DF1.2 Building on land subject to dampness	DF5.2 Means of compliance
DF1.3 Drainage of land external to building	DF5.3 Pipes which are not easy to access
DF1.4 Weatherproofing of roofs and walls	DF5.4 Access to domestic-type water heaters
DF1.5 Pliable roof sarking	DF5.5 Rainwater storage
DF1.6 Water proofing of wet areas in buildings	DF6 Sanitary Plumbing and Drainage
DF1.7 Damp-proof courses and mortars	DF6.1 General
DF1.8 Acceptable damp-proof courses	DF6.2 Means of compliance
DF1.9 Damp-proofing of floors on the ground	DF6.3 Fixture unit ratings
DF2 Cooking and Sanitary Facilities	DF6.4 Trapping of fixtures and appliances
DF2.1 Facilities required	DF6.5 Fixture discharge pipes
DF3 Room Sizes and Heights	DF6.6 Unvented branch drains
DF3.1 Height of rooms	DF6.7 Venting
DF3.2 Reduced height permissible	DF6.8 Design of pipes and drains
DF3.3 Ceiling fans	DF6.9 Gully traps other than floor waste gullies
DF3.4 Floor area	DF6.10 Floor waste gullies
DF4 Light and Ventilation	DF6.11 Inspection openings
DF4.1 Provision of natural light	DF7 Roof Drainage
DF4.2 Methods and extent of natural lighting	DF7.1 Design of roof gutters
DF4.3 Natural light borrowed from adjoining room	DF7.2 Design of downpipes
DF4.4 Artificial lighting	DF7.3 Incompatible metals for gutters
DF4.5 Ventilation of rooms	Specification
DF4.6 Natural ventilation	Specification DF 2.1 Latrines for Areas where there is no Water Supply
DF4.7 Ventilation borrowed from adjoining room	Specification DF 5.5 Rainwater Storage
DF4.8 Restriction on position of WCs and urinals	
DF4.9 Airlocks	
DF4.10 Sub-floor ventflator	

PERFORMANCE REQUIREMENTS

DAMP AND WEATHERPROOFING

OBJECTIVES

DFP1 The design and construction of a Class 1 building must meet the following objectives -

- (a) freedom from unhealthy and uncomfortable damp and wet conditions;
- (b) proper facilities for the preparation and cooking of food and the cleaning of utensils;
- (c) adequate facilities for personal washing and the washing of clothes;
- (d) hygienic toilet facilities with adequate privacy and which will not be a nuisance to anyone;
- (e) sufficient living space for privacy and comfort;
- (f) adequate light and ventilation consistent with the requirements of health hygiene and comfort;
- (g) where a public or private water supply exists, an appropriate safe and hygienic system of plumbing for the supply of water for domestic needs;
- (h) where a reticulated system of water supply is installed in the building, an appropriate system of drainage for the hygienic conveyance of sewage and waste water;
- (i) where a roof drainage system is provided, it must give reasonable protection against the overflow of rainwater into the building; and
- (j) unhealthy ponding of water in the allotment must not be allowed and the erection of the building or any alteration to it must not adversely affect the drainage of other allotments or of any public land.

REQUIRED PERFORMANCE

DFP 1.1 Damp and weatherproofing

Buildings must be so sited and suitable damp and weatherproofing provided where necessary to prevent-

- (a) moisture or damp affecting the stability of the building;
- (b) the creation of any unhealthy or dangerous condition;
- (c) damage or defacement from moisture present at the completion of construction;
- (d) causing undue damage to adjoining property; or

- (e) the accumulation of surface water against the building or beneath the floor.

DFP1.2 Cooking and sanitary facilities

Adequate cooking toilet and washing facilities must be provided for the occupants to allow reasonable comfort, hygiene and privacy.

DFP1.3 Room sizes

The floor area, plan dimensions and ceiling heights of rooms and other spaces must be adequate for living purposes.

DFP1.4 Light and ventilation

The standard of light and ventilation within a building must be adequate for the occupants, having regard to health hygiene and comfort.

DFP1.5 Water supply plumbing

Plumbing for water supply must use materials which do not react with the water and thereby make it unsuitable for domestic use. Suitable precautions must be taken to ensure that unsafe or unhygienic materials have no chance of entering the supply system. The installation of hot water systems must not impair the safety of the users. All concealed and difficult-to-access plumbing work must be suitably protected so that there is no likelihood of damage and leakage. The plumbing must take into account the current and anticipated needs of the users and allow for the simultaneous use of the connected system by others. Where rainwater from the roof run off is the source of supply care must be exercised to ensure that there is no reasonable chance for the water to become contaminated. Allowance must be made for lean years of rainfall.

DFP1.6 Sanitary plumbing and drainage

Sanitary plumbing must be laid to self-cleansing grades consistent with their discharge loading, unless other suitable arrangements are made to ensure that the system is kept free of the accretion of sewage and other waste matter. The size of drains and the layout of their connections must reasonably ensure the current and anticipated needs of the users. The connections to sanitary installations must ensure that foul gases are not allowed to produce unhygienic conditions nor create any nuisance to anyone and are suitably vented.

DFP1.7 Roof drainage

The roof drainage system must be capable of handling peak intensities of rainfall as follows:

- (a) Eaves gutters and downpipes - a 20 year return intensity.
- (b) Internal box gutters, valley gutters and downpipes - a 100 year return intensity.

Any known local variation in rainfall intensity must be taken into account. Sufficient allowance must be made for the possibility of overflow into the building due to ripples and turbulence in the flowing water during cyclonic winds.

DFP1.8 Site drainage

The immediate site around the building must have suitable drainage so that no ponding results. Visible water must not be allowed to remain under or around for more than 1 hour after 10 minutes of maximum rainfall resulting from a storm with a return period of 5 years. Flood waters or waves resulting from a storm or cyclone with a return period of 30 years must not be allowed to enter a building.

DEEMED-TO-SATISFY PROVISIONS

DAMP AND WEATHERPROOFING

DF1.1 Site drainage

The construction of a site drainage system and the position and manner of discharge of a stormwater drain must not-

- (a) result in the entry of water into any building or other allotments;
- (b) affect the stability of any building; or
- (c) create any unhealthy or dangerous condition within or around any building.

DF1.2 Building on land subject to dampness

One or more of the following measures must be carried out if it is warranted by the dampness of the building site:

- (a) The subsoil must be adequately drained.
- (b) The ground under the building must be regraded or filled and provided with outlets to prevent accumulation of water.
- (c) The surface of the ground under the building must be covered with a suitable damp-resisting material.

DF1.3 Drainage of land external to building

A suitable system of drainage must be provided if paving, excavation or any other work on an allotment will cause undue interference with the existing drainage of rainwater falling on the allotment whether the existing drainage is natural or otherwise.

DF1.4 Weatherproofing of roofs and walls

Roofs and external walls must be constructed to prevent rain or dampness penetrating to the inner parts of a building.

DF1.5 Pliable roof sarking

Pliable roof sarking-type material used under roof or wall coverings must comply and be fixed in accordance with-

- (a) AS 1736; or
- (b) AS 1903 and AS 1904.

DF1.6 Water proofing of wet areas in buildings

The following parts of a building must be impervious to water:

- (a) in any building - the floor surface or substrate in a shower enclosure, or within 1.5 m measured

horizontally from a point vertically below the shower fitting, if there is no enclosure;

- (b) The wall surface or substrate-
 - (i) of a shower enclosure, or if the shower is not enclosed, within 1.5 m and exposed to a shower fitting, to a height of 1.8 m above the floor;
 - (ii) immediately adjacent or behind a bath, trough, basin, sink, or similar fixture, to a height of 300 mm above the fixture if it is within 75 mm of the wall.
- (c) The junction between the floor and wall if the wall and floor are required to be impervious to water.
- (d) The junction between the wall and fixture if the wall is required to be impervious to water.

DF1.7 Damp-proof courses and mortars

Moisture from the ground must be prevented from reaching-

- (a) the lowest floor timbers and the walls above the lowest floor joists;
- (b) the walls above the damp-proof course; and
- (c) the underside of a suspended floor constructed of a material other than timber, and the supporting beams or girders.

DF1.8 Acceptable damp-proof courses

A damp-proof course must consist of-

- (a) a material that complies with AS 2904; or
- (b) suitable termite shields placed on piers; or
- (c) other suitable material.

DF1.9 Damp-proofing of floors on the ground

If a floor of a room is laid on the ground or on filling moisture from the ground must be prevented from reaching the upper surface of the floor and adjacent walls by-

- (a) the insertion of a vapour barrier in accordance with AS 2870.1; or
- (b) other suitable means.

COOKING AND SANITARY FACILITIES

DF2.1 Facilities required

Cooking and sanitary facilities must be provided as shown in Table DF2.1.

TABLE DF2.1
PROVISION OF COOKING AND SANITARY FACILITIES

MINIMUM FACILITIES REQUIRED	
In all cases	a) facilities for the preparation and cooking of food, and for the cleaning of utensils.
Where there is piped water supply to the kitchen and ablution areas	(b) a kitchen sink in a kitchen (c) a shower or other adequate personal washing facilities. (d) clothes washing facilities. (e) a closet pan and facilities for washing hands.
Where there is piped watersupply only to a tap in the kitchen or up to a stand- pipe in the vicinity of the building or where there is no piped water supply	(f) a paved raised platform with a paved area and drain around it. (g) a suitable type of privy as per Specification DF2.1.

NOTE:

- i) If any of these facilities are detached from the main building, they must be set aside for the exclusive use of the occupants of the building.
- ii) Where the layout allows it, facilities in (c), (d) and (e) can be in the same room.

ROOM SIZES AND HEIGHTS**DF3.1 Height of rooms**

Minimum heights below the ceiling and any framing excluding minor projections such as cornices, are:

- (i) *habitable room* - average 2.4 m and minimum of 2.1 m; and
- (ii) bathroom, shower room, water closet, laundry, pantry, or the like - 2.1 m.

DF3.2 Reduced height permissible

These heights may be reduced if the reduction does not unduly interfere with the proper functioning of the room.

DF3.3 Ceiling fans

Ceiling fans and other such appliances must be at a minimum vertical clearance of 2.1 m.

DF3.4 Floor area

The minimum *floor area* of any *habitable room* excluding a kitchen must be 6 m². The minimum size of a toilet must be 1.5 m x 0.75 m and of a shower cubicle, 0.74 x 0.74 m.

LIGHT AND VENTILATION

DF4.1 Provision of natural light

Natural lighting must be provided to all *habitable rooms*.

DF4.2 Methods and extent of natural lighting

Direct natural lighting must be provided by *windows* that-

- (a) have an aggregate light transmitting area measured excluding framing members, glazing bars or other obstructions of not less than 10% of the *floor area* of the room;
- (b) face-
 - (i) a court or other space open to the sky; or
 - (ii) an open verandah, open carport, or the like;
- (c) are not less than a horizontal distance of 1 m from any boundary of an adjoining allotment that they face.

DF4.3 Natural light borrowed from adjoining room

Natural lighting to a room may come through a glazed panel or opening from an adjoining room (including an enclosed verandah) if-

- (a) the glazed panel or opening has an area of not less than 10% of the *floor area* of the room to which it provides light;
- (b) the adjoining room has *windows* with an aggregate light transmitting area of not less than 10% of the combined *floor areas* of both rooms,

and the areas specified in (a) and (b) may be reduced as appropriate if direct natural light is provided from another source.

DF4.4 Artificial lighting

Artificial lighting must be provided to sanitary compartments, bathrooms, shower rooms, airlock and laundries, if natural lighting of a standard equivalent to that *required* by DF4.2 is not available and the periods of occupation, or use of the room or space will create undue hazard to occupants seeking egress in an emergency.

DF4.5 Ventilation of rooms

A *habitable room*, *sanitary compartment*, bathroom, shower room, laundry and any other room occupied by a person for any purpose must be provided with natural

ventilation complying with DF4.6. Where it is not practical to provide natural ventilation for any *sanitary compartment*, bathroom, shower or laundry, it is permissible to substitute natural ventilation with a mechanical ventilation system. In such a case the system must satisfy the requirements of AS 1688 - 2.

DF4.6 Natural ventilation

Required natural ventilation must be provided by permanent *windows*, openings, doors or other devices -

- (a) with an aggregate opening or openable size not less than 10% of the *floor area* of the room *required* to be ventilated; and
- (b) which open to-
 - (i) a court, or space open to the sky; or
 - (ii) an open verandah, open carport, or the like.

DF4.7 Ventilation borrowed from adjoining room

Natural ventilation to a room may come through a *window*, opening, ventilating door or other device from an adjoining room (including an enclosed verandah) if -

- (i) the room to be ventilated or from which ventilation is borrowed is not a *sanitary compartment*;
- (ii) ventilation is not borrowed from one bedroom to another or between a bedroom and the kitchen;
- (iii) the *window*, opening, door or other device has a ventilating area of not less than 10% of the *floor area* of the room to be ventilated; and
- (iv) the adjoining room has a *window*, opening, door or other device with a ventilating area of not less than 10% of the combined *floor areas* of both rooms.

NOTE: the ventilating areas specified may be reduced as appropriate if direct natural ventilation is provided from another source.

DF4.8 Restriction on position of WCs and urinals

A room containing a closet pan or urinal must not open directly into-

- (a) a kitchen; or

- (b) a room for storage or consumption of food, except if it is in a building containing only one *habitable room*.

DF4.9 Airlocks

If a room containing a closet pan or urinal is prohibited under DF4.8 from opening directly to another room -

- (i) access must be by an airlock, hallway or other room; or
- (ii) the room containing the closet pan or urinal must be provided with an exhaust fan.

DF4.10 Sub-floor ventilation

- (a) Suitable provision must be made to prevent undue deterioration of the lowest floor of a building because of dampness, other conditions on the allotment or the design of the building.
- (b) The following would satisfy the requirements of (a) -

- (i) where timber is used, the floor framing must be suspended with an absolute minimum of 250 mm and an average minimum of 400 mm clearance from the ground underneath, to the floor and the immediate surrounds of the building. The average clearance must be determined as the average of the clearances at the corners of a 3 m square grid covering the building plan. Subfloor ventilation must be provided with ventilation openings totalling not less than 3% of the peripheral vertical area between the ground and the boundary of the floor. These openings are to be spaced uniformly at not more than 1.8 m apart.

- (ii) where other than timber is used the following must be provided -

Subfloor ventilation if the floor is suspended;

an impervious cover over the ground surface beneath the building; or

the floor members suitably treated.

WATERSUPPLY PLUMBING

DF5.1 General requirements

The plumbing work for water supply must ensure -

- (a) the appropriateness of the materials and products used;
- (b) the correct sizing of water services for the intended use;
- (c) the control of cross-connections and prevention of backflow;
- (d) adequate care in the installation of the services;
- (e) suitable provision of main and subsidiary storage as required;
- (f) adequate connections to sanitary services without endangering health and hygiene; and
- (g) that the installation of hot water systems provide safe and adequate service.

DF5.2 Means of compliance

The requirements of DF5.1 are satisfied if all plumbing for watersupply is carried out to the relevant provisions of -

- (a) AS 3500 - Part 1 for cold water service; and
- (b) AS 3500 - Part 4 for hot water service.

DF5.3 Pipes which are not easy to access

Particular attention is drawn to the provisions in AS 3500 - Parts 1 and 4 which prohibit the installation of pipes and fittings of certain materials in locations which are concealed

or difficult to access. These include pipes made of ABS, galvanised steel, polybutylene and UPVC. Pipes and fittings made of copper, copper alloy, stainless steel, ductile iron, cast iron and polyethylene when used in concealed or difficult to access locations must follow the special precautions specified in AS 3500 - Parts 1 and 4.

DF5.4 Access to domestic-type water heaters

- (a) A household water heater which is installed in a building must-
 - (i) be supported on construction sufficient to carry its full capacity weight and any possible wind or earthquake loads;
 - (ii) be positioned to enable adequate access for operation, maintenance and removal; and
 - (iii) provide suitably for any overflow, especially if installed in a concealed location.
- (b) AS 3500 - Part 4 is the relevant standard for the installation of a household water heater.

DF5.5 Rainwater storage

Where rainwater is collected and stored, the storage and distribution must reasonably ensure that the water is not contaminated by unsafe or unsuitable materials. The capacity of the catchment and storage must be adequate to provide a continued supply of water during years of low rainfall.

The details given in Specification DF5.5 meet the requirements of this clause.

SANITARY PLUMBING AND DRAINAGE

DF6.1 General

DF6.1.1 Requirements

Sanitary plumbing and drainage must ensure -

- the appropriateness of the products and materials used;
- the correct sizing of drainage services for the intended use;
- adequate care in the installation of the services including the provision of appropriate grades; and
- that foul gases are not allowed to produce unhygienic conditions or any nuisance to anyone.

DF6.1.2 Some common terms

Apart from the defined terms given in A1.1 the following terms used in this Section are explained:

- Nominal size (DN)

While converting to metric dimensions some manufacturers of pipes and fittings have used hard conversion whereas others have used soft conversion. For these and other reasons it is impractical to specify exact pipe and fitting dimensions. All pipes and fittings in this Section are therefore specified by their nominal size. This is indicated by the letters "DN" followed by a number.

Since this number is only an approximation of the actual size, it is not subject to exact measurement and must not be used in calculations. The nominal size is thus only a numerical designation of the size which is common to all components in a piping system (other than components such as steel tubes which are designated by their outside diameter and other components by their thread size). It is just a convenient round number for reference purposes and is only loosely related to the manufacturing dimensions.

- Trap

A trap is a device which retains a water seal for preventing the escape of sewer gases from sanitary plumbing. Figure DF6.1.2 shows two common types of fixture traps. There are also traps integral with gullies, water closet pans etc.

The water seal can be broken by self-siphonage or induced siphonage as well as by positive pressure of the gases breaking through the seal. It is also possible for the seal to be dried out by prolonged non-use of the associated part of the system.

The best means of preventing the loss of the seal by siphonage or by positive pressure is to vent the trap to the outside air.

- Fixture discharge pipe

This is the discharge pipe to which any single sanitary fixture is connected.

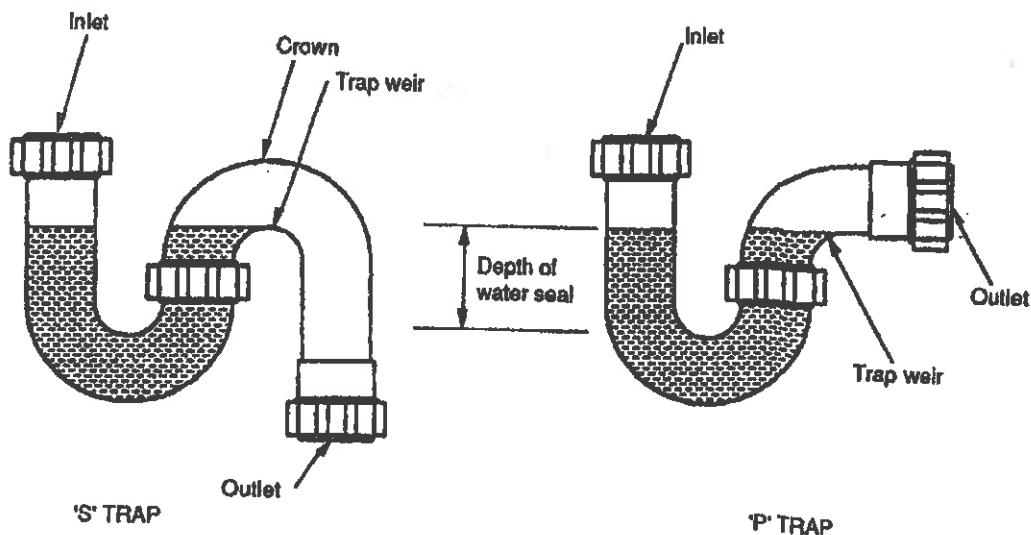

FIGURE DF6.1.2 EXAMPLES OF FIXTURE TRAPS

(d) Gullies

A gully is an assembly used for providing a water seal when handling the discharge from only waste fixtures and not any soil fixture. The water seal prevents the escape of foul gases into the building or into the atmosphere in the vicinity of the assembly.

It is a disconnector gully when it provides a separation through the water seal, between the discharge from waste fixtures and the rest of the sanitary system.

A floor waste gully is a disconnector gully used inside a building with a floor grating or waste outlet fitting on a riser pipe. Discharge pipes from waste fixtures may also connect to a floor waste gully.

An overflow relief gully functions as a self-cleaning trap and is provided with a loosely fitted grating. This allows for the relief of any possible surcharge or overflow from the drain. The riser of the gully may have inlets for discharge from waste fixtures.

DF6.2 Means of compliance

The requirements of DF6.1.1 are satisfied if all sanitary plumbing and drainage works are carried out to the relevant provisions of AS 3500 - Part 2 - Sanitary plumbing and sanitary drainage, as well as this part of the Code.

DF6.3 Fixture unit ratings

In the design of discharge pipes and drains the fixture unit ratings shown in Table DF6.3 must be used. For the fixtures listed in the Table the maximum unvented length of the associated fixture discharge pipe must not exceed 2.5 m except that this may be 6 m for a water closet pan with a DN100 trap and discharge pipe. The length of the pipe is measured along the centre line from the weir of the trap to the point of connection to a graded discharge pipe, drain, stack or other drainage trap.

Fixture	Nominal size of trap outlet and fixture discharge pipe	Fixture unit rating
Basin	DN30 or DN40	1
Bath (with or without shower)	DN40	4
Bidet	DN40	1
* Clothes washing machine	DN40	5
* Dishwashing machine	DN40	3
Floor waste gully - without fixture - with fixture	DN50 DN40 or DN 50	0 as per fixture rating
Laundry trough	DN40 or DN 50	5
Shower	DN40 or DN50	2
Sink - less than 45 litres - more than 45 litres	DN40 DN50	2 3
Water closet pan	DN80 or DN100	5

* (i) When a clothes washing machine connects to a trough trap, only the trough unit fixture rating is considered.
 (ii) When a dishwashing machine connects to a sink trap only the sink fixture unit rating is considered.

DF6.4 Trapping of fixtures and appliances

DF6.4.1 The discharge from all sanitary fixtures and appliances must pass through traps before entering the drain, soil pipe or waste pipe. The fixture trap must retain a water seal of:

- (a) 50 mm for traps of size DN50 or less
- (b) 75 mm for traps of size greater than DN50

The traps must be located as close as possible to the fixture and not farther than 600 mm from the fixture outlet, except in case of permitted fixture pairs and floor waste gullies.

DF6.4.2 The following fixtures may be connected in pairs to a single fixture trap:

- (a) Wash basins
- (b) Sinks
- (c) Laundry troughs
- (d) Showers

The fixture pairs must be connected so that the centre to centre distance between their outlets is no more than 1.2 m.

DF6.5 Fixture discharge pipes

DF6.5.1 Minimum grades

Discharge pipes must be laid to the minimum grades shown in Table DF6.5.1

Nominal size	Minimum grade
DN30	1 in 30
DN40	1 in 40
DN65	1 in 40
DN80	1 in 60
DN100	1 in 60

DF6.5.2 Connections

The connection of any fixture discharge pipe to a graded discharge pipe or between two graded discharge pipes must be made as follows:

- (a) With 45° or sweep junction fittings;

(b) Where the pipes are of different sizes-

- (i) the soffits of both must be in continuous alignment, and
- (ii) where an unequal junction fitting is used, the soffit of the branch pipe must be at the same level or higher than the soffit of the pipe to which it connects; and

(c) The level of the trap or floor waste gully weir must be at a higher level than the soffit of the graded discharge pipe to which it connects.

DF6.5.3 Cleaning eyes

Fixture discharge pipes must have accessible cleaning eyes at all bends.

DF6.6 Unvented branch drains

Where the risk of escape of dangerous and unpleasant gases into occupied premises is minimal the venting of branch drains is not required. However all of the limitations given in the following sub-clauses and illustrated in figure DF6.6 must be met in such cases. (For limitation of length of fixture discharge pipes, see DF6.3.)

DF6.6.1 Limitations on location or nature of connection

- (a) The connection of any unvented branch drain to a vented drain must be located at the ground floor level and the vented drain installed on grade below or above ground;
- (b) In the case of an unvented drain receiving discharge from only waste fixtures, it must connect to a gully;
- (c) An unvented drain other than in (b) must connect to a disconnector gully; or
- (d) The connection must be from a discharge pipe serving a single fixture and the length of the discharge pipe is-
 - (i) less than 3.5 m when serving a waste fixture; or
 - (ii) less than 3.0 m when serving a soil fixture.

DF6.6.2 Limitations on size, length and bends

- (a) The size of any unvented branch drain must comply with the limitations given in Table DF6.6.2

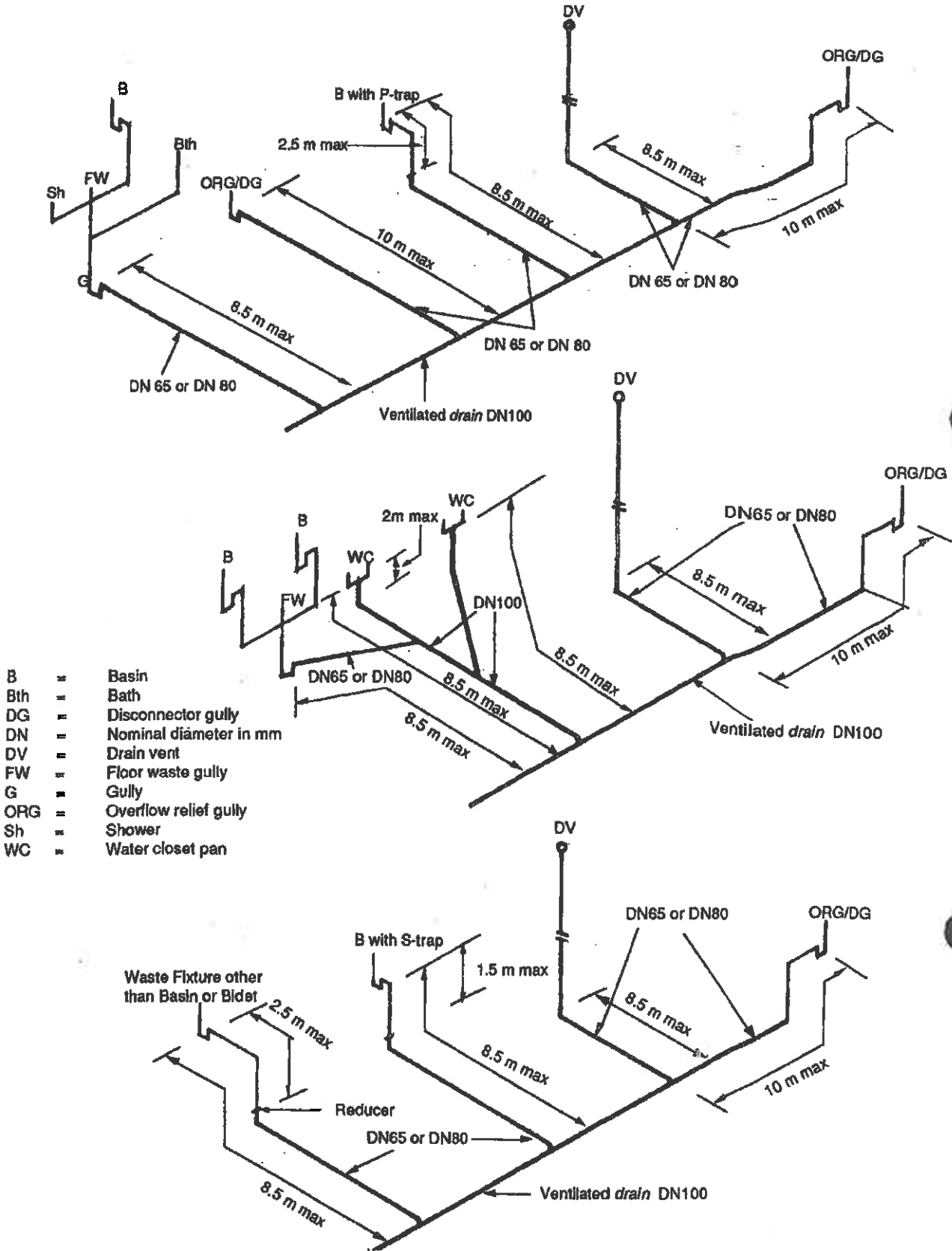

- B = Basin
- Bth = Bath
- DG = Disconnecter gully
- DN = Nominal diameter in mm
- DV = Drain vent
- FW = Floor waste gully
- G = Gully
- ORG = Overflow relief gully
- Sh = Shower
- WC = Water closet pan

FIGURE DF6.6 LIMITATIONS ON UNVENTED BRANCH DRAINS

**TABLE DF6.6.2
SIZE OF UNVENTED BRANCH DRAINS**

Nominal size	Maximum sum of <i>fixture unit</i> loadings discharging into the branch <i>drain</i>
DN65	5 (but not from a water closet pan) or 8 from one floor waste gully
DN80	12 (no more than 1 water closet pan connected)
DN100	30 (no more than 2 water closet pan connected)

(b) The length of an unvented branch *drain* together with that of the fixture discharge pipe must not exceed -

- (i) 8.5 m from the weir of the fixture trap;
- (ii) 10 m to a disconnector gully; and
- (iii) 2.5 m from the reducer to the weir of the trap, where the fixture discharge pipe is of smaller size than the unvented branch *drain*.

(c) The maximum vertical drop from the crown of the trap to the top of the vented *drain* to which the unvented branch *drain* connects must not exceed -

- (i) 1.5 m in the case of basins and bidets; and
- (ii) 2.5 m in the case of all other fixtures.

(d) The total combined number of long bends in a fixture discharge pipe and branch *drain*, up to the connection with a vented *drain* must be limited to:

- (i) 2 horizontal and 2 vertical with basins and bidets; and
- (ii) 2 horizontal and 3 vertical with all other fixtures. The distance between any adjacent horizontal bends must be not less than 300 mm and the vertical drop between two adjacent vertical bends must not exceed 2 m.

Note: A bend of 45° or less is not considered to be a bend for the purposes of this clause.

DF6.7 Venting

In order to prevent the escape of dangerous and unpleasant gases into occupied premises and to ensure that water seals in traps are not destroyed by siphonage, adequate

venting must be provided for all fixture discharge pipes and *drains* except as allowed by DF6.6.

DF6.7.1 Trap vents

The minimum size of a trap vent must be related to the nominal size of the fixture trap as follows:

Size of fixture trap	Size of trap vent
DN30 or DN40	DN30
DN50 to DN100	DN40

Every trap vent must be extended upward at least 50 mm above the flood level rim of the fixture. This may be accomplished in one of the following ways:

- (a) As a vertical vent to open air, the outlet of which is no closer than 900 mm from any opening to the building;
- (b) On an ascending grade of at least 1:80 and then:
 - (i) as a vertical vent to the open air; or
 - (ii) to a connection with a vertical or branch vent.
- (c) Take the vent above the flood level rim of the fixture, then loop it down: either vertically or on a downward grade of 1:80 and connect to a vertical or branch vent.

Trap vents must be located no closer than 75 mm and no farther than 1500 mm from the crown of the trap.

DF6.7.2 Drain vents

(a) General

Vents in *drains* must be provided -

- (i) at the upstream end of any *drain*;
- (ii) at the upstream end of any branch *drain* to which a fixture trap or floor waste gully is connected and if the distance from the weir of the trap to the vented *drain* exceeds 8.5 m;
- (iii) at the upstream end of any DN100 branch *drain* to which 3 or more water closet pans are connected; and
- (iv) at the upstream end of any DN80 branch *drain* to which no more than 2 water closet pans are connected.

(b) Location

The upstream vent of any drain must be connected-

- (i) at or close to the end of the drain; or
- (ii) at the vent extension of a stack located at or near the upstream end of the drain.

In either case it is permissible to have an unvented length of drain upstream of the vent connection if the unvented length complies with DF6.6.

(c) Size of vents

The minimum size of an upstream vent of any drain is DN50. Subject to this, the vent must be sized by using the ratings given in Table D6.7.2.

- (ii) not less than 150 mm above its point of penetration through any roof covering;
- (iii) not less than 3 m above any trafficable roof deck which is within a horizontal distance of 3 m from the vent;
- (iv) not less than 2 m above or 600 mm below any chimney or similar opening within a horizontal distance of 3 m from the vent;
- (v) not less than 5 m from any air intake; and
- (vi) not less than 600 mm above any eave, coping or parapet which is within a horizontal distance of 600 mm from the vent.

**TABLE DF6.7.2
SIZE AND RATING OF DRAIN VENTS**

Fixture units discharging into drain	Vent rating	Vent size
1 to 10 (incl)	0.5	DN40
10 (excl) to 30 (incl)	1	DN50
30 (excl) to 175 (incl)	2	DN65
175 (excl) to 400 (incl)	3	DN80

When two or more vents are directly connected to the drain these can take the place of a single vent provided the sum of their ratings is not less than the rating required for venting the drain.

DF6.7.3 Termination of vents

(a) Vent pipes from waste fixtures discharging into disconnector gullies and from gullies located within buildings must be vented independently and not be interconnected to any other system vent. Such vents must terminate in the open air:

- (i) at a height of at least 50 mm above the overflow level of the associated fixture;
- (ii) at least 900 mm from any opening to the building which is within a horizontal distance of 3 m from the vent; and
- (iii) not less than 150 mm above its point of penetration through any roof covering.

(b) Vents other than in (a) must terminate in the open air:

- (i) not less than 600 mm above any opening into any building which is within a horizontal distance of 3 m from the vent;

DF6.8 Design of pipes and drains

DF6.8.1 Sizing of discharge pipes

Discharge pipes must be not less than the size of the fixture traps to which they are connected. The size must be determined from Table DF6.3 and take into consideration:

- (i) the sum of the fixture unit rating of all fixtures connected to the pipe;
- (ii) the proposed pipe gradient; and
- (iii) the maximum fixture unit loadings given in Table DF6.8.1

**TABLE DF6.8.1
MAXIMUM FIXTURE UNIT LOADINGS FOR GRADED DISCHARGE PIPES**

Grade	Nominal pipe size (mm)				
	40	50	65	80	100
1 in 20	6	15	51	65	376
1 in 30	5	10	29	39	248
1 in 40	4	8	21	27	182
1 in 50	x	x	x	20	142
1 in 60	x	x	x	16	115

Note

- (i) x indicates that the combination of pipe size and gradient is not permitted.
- (ii) Not more than 2 w.c. pans are to be connected to any 80 mm pipe

DF6.8.2 Sizing of drains

The size of a vented *drain* must be determined by taking into account the total number of *fixture units* (obtained from Table DF6.3) discharging into the drain.

(a) Normal grades

The minimum normal grade of *drains* must be as given in Table DF6.8.2A

Nominal size (mm)	Minimum grade
80	1 in 60
100	1 in 60
125	1 in 80
150	1 in 100

(b) Maximum *fixture unit* loadings for vented *drains*

The *fixture unit* loadings for vented *drains* must not exceed the values given in Table DF6.8.2 B for the size and grade of the *drain* shown.

Grade	Nominal pipe size (mm)			
	80	100	125	150
1 in 20	215	515	1450	2920
1 in 30	140	345	1040	2200
1 in 40	100	255	815	1790
1 in 50	76	205	665	1510
1 in 60	61	185	560	1310
1 in 70	50	140	485	1180
1 in 80	42	120	425	1040
1 in 90	x	x	380	935
1 in 100	x	x	340	855
1 in 120	x	x	x	725
1 in 150	x	x	x	595

Note: x indicates that the combination of nominal size and grade is not permitted.

(c) Reduced grades

Where the minimum grades given in Table DF6.8.2A are not achievable *drains* may be laid at the reduced grades given in Table DF6.8.2 C. In such a case the minimum *fixture unit* loadings given in

the Table must be connected in advance of the top end of the reduced grade. Where even these reduced grades cannot be achieved provision must be made for regular and automatic flushing of the *drain*.

Reduced grade	Nominal pipe size (mm)			
	80	100	125	150
	Minimum <i>fixture unit</i> loading			
1 in 70	9	10	See Table DF6.8.2A	
1 in 80	10	18	"	"
1 in 90	x	x	27	"
1 in 100	x	x	38	"
1 in 120	x	x	x	75
1 in 150	x	x	x	160

Note: x means that the grade is not permitted unless special automatic flushing arrangements are made.

(d) A *drain* must not be oversized for the only purpose of using a lower gradient than the minimum gradient given in Table DF6.8.2A. The size of a *drain* must not reduce in the direction of flow.

DF6.8.3 Cover over drains

(a) *Drains* must be protected against any mechanical damage and deformation resulting from the loads over them. Adequate cover must be provided to comply with Table DF6.8.3 unless exempted under (b).

Location	Minimum cover from top of pipe socket to ground surface (mm)	
	Pipes of cast iron or ductile iron	Pipes of other materials
Household driveways	300	450
Other locations where no vehicular loadings are expected	Nil	300

(b) Where it is not practical to provide the minimum cover to Table DF6.8.3, *drains* must be covered by a sandy overlay of at least 50 mm and provided with-

DF6 SANITARY PLUMBING AND DRAINAGE

- (i) 75 mm thick concrete paving where light vehicular traffic may be expected; and
- (ii) 50 mm thick concrete paving at other locations where vehicular traffic is not expected.

The paving must be symmetric to the *drain* alignment and must have a minimum width equal to the depth of the base of the drain from the top of the paving plus 300 mm.

DF6.8.4 Drains close to buildings

(a) *Drains under buildings*

Where it cannot reasonably be avoided *drains* may be laid below ground under buildings in which case-

- (i) inspection openings must be provided at both ends of the *drain* adjacent to the building; and
- (ii) a minimum of 50 mm of sandy overlay provided over the pipe and below a reinforced concrete floor slab; or
- (iii) the *drain* must be protected from damage.

(b) *Proximity of buildings*

- (i) where a *drain* is to be laid parallel to a footing the excavation for it must clear a line at 45° from the extremity of the footing. (See Figure 6.8.4)
- (ii) where a *drain* crosses a strip footing, the angle of crossing must be not less than 45° and the top of the *drain* must clear the bottom of the footing by not less than 50 mm.

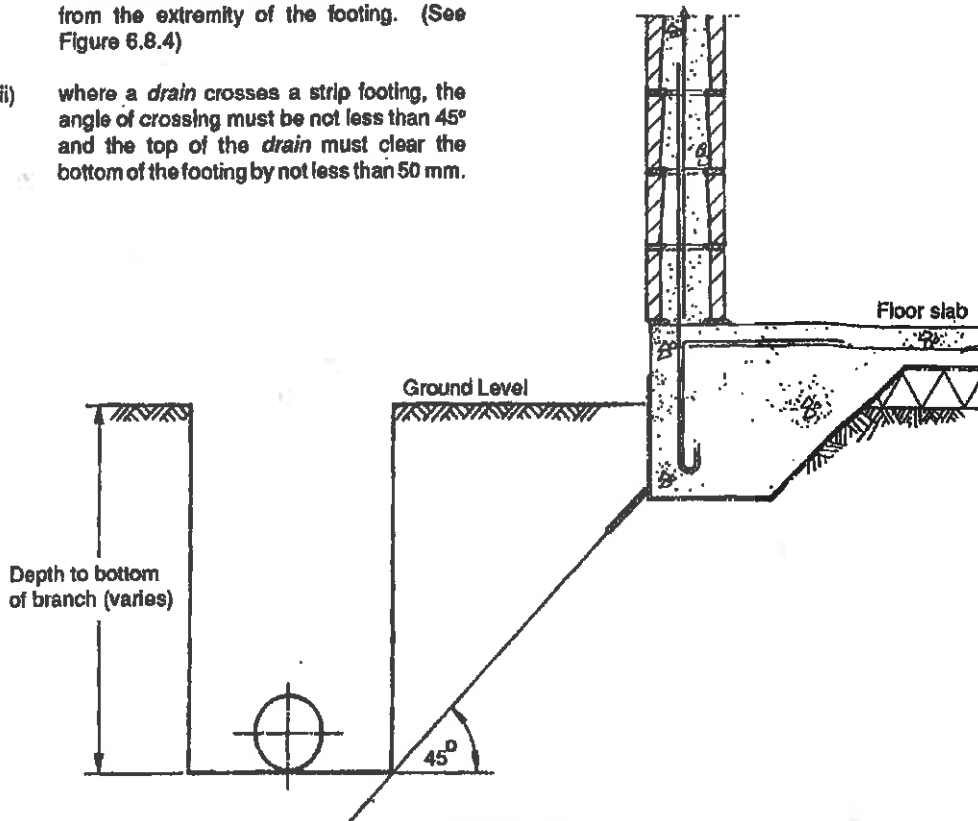

FIGURE DF6.8.4

(c) *Building over drains*

Where it is not practical to divert *drains* in order to avoid erecting buildings over them -

- (i) the restrictions listed in (a) and (b) must be observed; and
- (ii) other appropriate engineering precautions taken against damage.

DF6.9 Gully traps other than floor waste gullies.

Gully traps may be used;

- (a) as overflow relief gullies to provide in the event of sewage surcharge; or
- (b) to provide disconnection between waste discharges and the remainder of the sewerage installation (disconnecter gullies).

DF9.1 General

- (a) A gully must be installed such that -
 - (i) it is supported on a minimum 75 mm thickness of concrete of 17.5 MPa grade; and
 - (ii) it is protected from damage at floor level by a concrete surround of minimum width and depth of 75 mm.

- (b) The following discharges must not be allowed into a gully:
 - (i) from any *soil fixture*; and
 - (ii) any rain water drainage from the roof or ground.
- (c) The gully must have its water seal maintained from a *waste fixture* or floor waste gully. The maximum length of unvented waste pipe discharging into the gully must be 2.5 m from basins or bidets, 6 m from all other waste gullies and fixtures with DN50 or smaller pipes, and 8.5 m from floor waste gullies and fixtures with DN65 or larger pipes.

DF6.9.2 Overflow relief gullies

At least one overflow relief gully must be installed in a *drain* which is connected to a public *sewer*.

(a) Size

The size of the overflow relief gully is related to the size of the main *drain*. For a size of main *drain* of DN80 the gully must also be DN80. For main *drains* of DN100 to 150 size, the gully must be DN100.

(b) Location

An overflow relief gully must be located within the property, external to the building, as far as practicable from the downstream end of the *drain*, and so that the top of the gully is accessible and positioned where any overflow can be easily noticed.

(c) Height

A minimum height of 150 mm must be kept between the top of the overflow gully riser and the lowest fixture connected to the *drain*. The point of measurement on fixtures is given in Table DF6.9.2.

**TABLE DF6.9.2
POINT OF MEASUREMENT OF FIXTURES FOR HEIGHT
ABOVE OVERFLOW LEVEL OF GULLY**

Fixture	Point of measurement
Soil fixture with integral trap	Level of water seal surface
Floor waste gully or shower outlet	Top surface level of grate
Other fixtures	Top surface level of fixture outlet

DF6.9.3 Disconnect or gully traps

Where installed within a building these must:

- (a) have the gully riser extend to floor level and be sealed with an airtight removable cover; and
- (b) a DN50 vent pipe must branch from the riser at an upward grade of not less than 1 in 80 and terminate with a grating at an external wall of the building above any likely flood level. Alternately the vent pipe can terminate as in DF6.7.3(a). No other fixture or appliance must be connected to the vent pipe.

DF6.10 Floor waste gullies

Floor waste gullies are functionally similar to fixture water traps. Shower outlets may be used as floor waste gullies. Any *waste fixture* may be connected to a floor waste gully. No trap is required other than for discharge outlets from basins. For other than basins the maximum length of the untrapped waste pipe must not exceed 1.2 m. If any of the fixtures is trapped, the maximum length of the waste pipe is allowed to be up to 2.5 m. However, the traps must not be vented. With the exception of allowed fixture pairs, each fixture must connect individually with the gully at a grade of not less than 1 in 40.

DF6.10.1 Size

The outlet size of a floor waste gully trap is based on the total *fixture units* of the fixtures and appliances discharging into it. The outlet size must be:

- (a) DN50 for a total *fixture unit* rating of 3 units or less; and
- (b) DN65 to DN100 for a total *fixture unit* rating of 10 or less.

A DN50 outlet and a DN50 riser may be used if the sole function of the gully is to dispose of water spillage and washdown water. All other gullies must have a minimum riser size of DN80 at floor level. A floor waste gully must have an accessible, removable grate.

DF6.10.2 Height of gully riser

The minimum height of the gully riser from the top of the water seal to the floor surface must comply with Table DF6:10.2. The maximum height must not exceed 600 mm.

**TABLE DF6.10.2
MINIMUM HEIGHT OF FLOOR WASTE GULLY RISERS**

Fixture connected	Minimum height from water seal to floor level (mm)	
	Waste pipe entry at 88.5°	Waste pipe entry at 45°
Shower	150	100
Bath (only one)	250	200
Clothes washing machine	300	250
Other waste fixtures	250	150

DF6.10.3 Maintenance of water seal

At least one *waste fixture* must be connected to any floor waste gully in order to maintain the water seal. For this reason the minimum depth of water seal must be 65 mm or the values in DF6.4.1, whichever is more.

DF6.11 Inspection openings

DF6.11.1 General

Inspection openings comprise:

- (a) inspection branches or square junctions; or
- (b) inspection chambers.

DF6.11.2 Location

Inspection openings must be provided:

- (a) outside the building on each branch connecting one or more water closet pans;
- (b) at intervals of not more than 30 m;
- (c) downstream and upstream ends of any section of *drain* that passes under a building;
- (d) where any new section of *drain* is connected to an existing *drain*; and
- (e) at the connection to the public sewer.

Appropriate locations are illustrated in Figure DF6.11.2.

DF6.11.3 Size

- (a) The size of inspection branches or square junctions must be:
 - (i) the same size as the *drain* for drains up to DN150; and

- (ii) not less than DN150 for larger drains.

- (b) The dimensions of inspection chambers must comply with Table DF6.11.3.

**TABLE DF6.11.3
SIZE OF INSPECTION CHAMBERS**

Minimum internal measurement (mm)			
Depth to floor of chamber	Rectangular		Circular
	Length	Width	Diameter
Less than 600	600	450	600
600 to 900	900	600	900
More than 900	1200	750	1050

DF6.11.4 Access for inspection branches and square junctions

Inspection branches and square junctions must be so located that it is possible to use them for inspection and for clearing obstructions in the associated sections of the *drain*. When located inside buildings inspection branches and square junctions must have their openings readily accessible. Such openings must have airtight removable caps or plugs with gaskets, rubber rings or such other accessories to maintain tightness. When the caps or plugs are removed for inspection/maintenance, the gasket/rubber ring must be replaced with a new one.

DF6.11.5 Construction of inspection chambers

- (a) Where required

An inspection chamber is required where an inspection branch or square junction:

- (i) cannot accommodate all the convergent drains; or
- (ii) will not permit proper inspection or the clearing of obstructions.

- (b) Conduits and channels

The conduits in inspection chambers may be open channels of size and shape equal to the associated drains. The floor in inspection chambers must slope at a grade of between 1 in 10 and 1 in 15 towards the channel. Any formed junction must have a centre line radius of not less than 300 mm. A fall of at least 30 mm must be provided in the invert of any channel that curves through 45° or more.

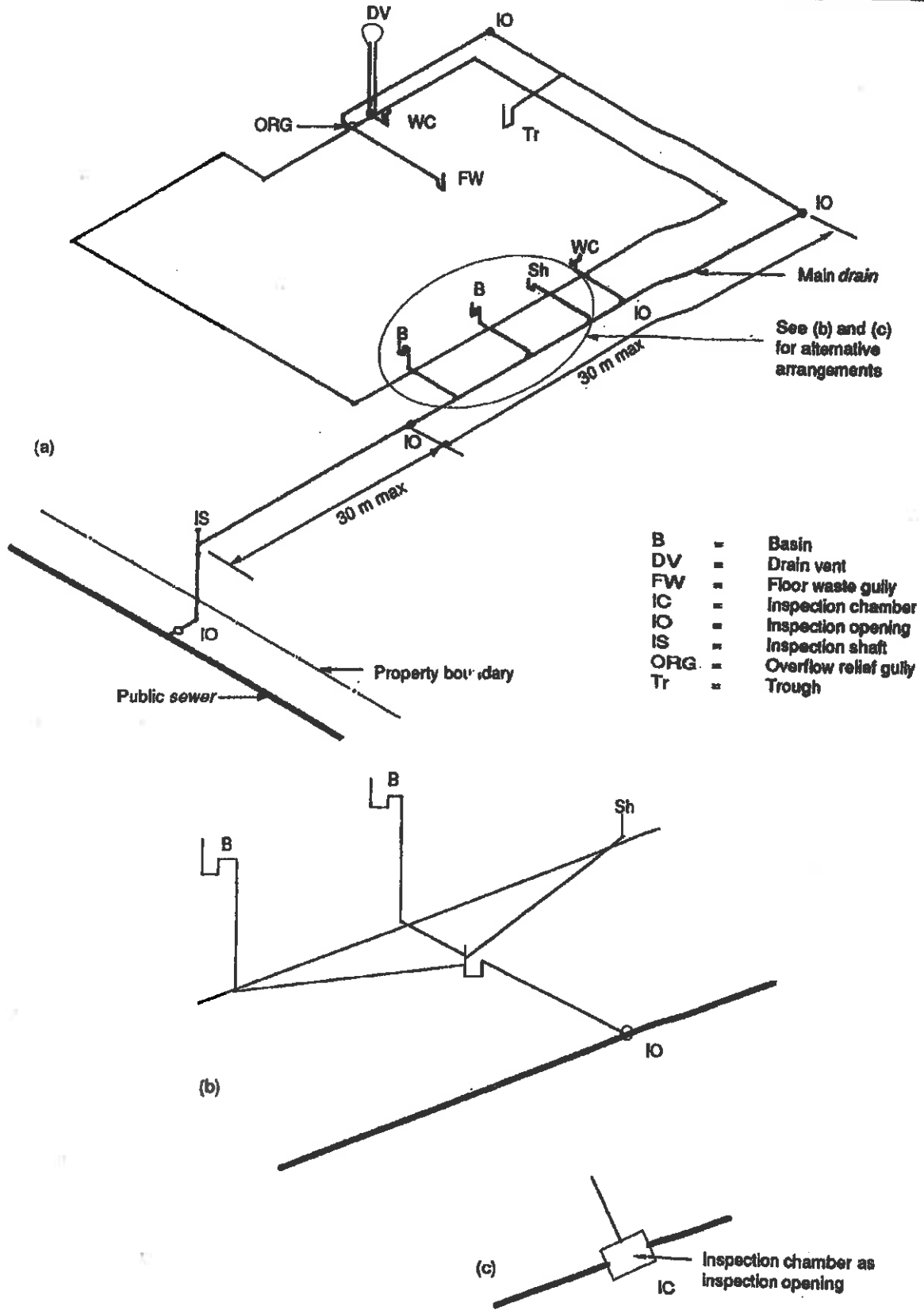

FIGURE DF6.11.2 LOCATION OF INSPECTION OPENINGS

(c) Access opening

A circular or rectangular access opening of 530 mm minimum dimension and fitted with a removable water tight cover must be provided at surface level. The cover must have been designed and installed to take any likely load on it. Where the size of the inspection chamber is larger than the size of the access opening, the top section of the chamber may be suitably tapered. Where this is done the full dimensions of the chamber must be maintained for a height from the chamber floor of at least 1.5 m, and the depth of the narrower shaft at the top not exceed 350 mm. The minimum dimension of the shaft except at the opening must be 600 mm.

(d) Access ladder

Where the depth of the chamber exceeds 1.2 m rungs or rung ladders must be provided to AS 1657.

(e) Materials of construction

Inspection chambers must have their base and walls of a minimum thickness of 150 mm and constructed of :

- (i) base - concrete; and
- (ii) walls - concrete or fully grouted concrete block masonry.

The concrete must be of 20 MPa grade. The walls and base must be suitably reinforced if required. The channels may be formed of half sections of pipes and fittings. Any access rungs or ladder must be of galvanised steel. The cover and any frame to seal it must be of reinforced concrete or cast iron with safe lifting devices.

The walls and base of any inspection chamber must be cement rendered to a smooth finish. The render may contain a suitable water proofing agent to ensure a waterproof finish. Where there is any likelihood of seepage of sub-soil water into the manhole the external surfaces of the wall must be plastered to a waterproof finish or a suitable water proofing agent added to the concrete in the walls and base.

(f) Inserts

The contact area between pipes or fittings and the walls formed around them, as well as holes broken into or formed in the walls of inspection chambers for insertion of pipes or fittings must be made water tight by -

- (i) the application of a suitable bonding agent around the pipes;
- (ii) caulking the annular space between the wall and the pipe or fitting with a stiff mix of one part cement and 2 parts sand;
- (iii) sealing with an epoxy based or other suitable sealant; or
- (iv) a combination of these methods.

DF6.11.6 Junctions

(a) Junctions of drains must -

- (i) be swept in the direction of flow or have an oblique junction fitting with an upstream angle of no more than 60°;
- (ii) not be Y junctions in the horizontal plane; and
- (iii) where unequal junctions are used have the soffit of the branch in level with or higher than the soffit of the larger size.

(b) Square junctions in drains must only be used:

- (i) at the connection of an inspection shaft to a graded drain;
- (ii) as the inlet riser of a gully or a floor waste gully;
- (iii) as an inspection opening; or
- (iv) at the top of a drop junction in place of a bend and inspection opening.

ROOF DRAINAGE

DF7.1 Design of roof gutters

- (a) Roof gutters where provided must be sized using the information given in Table DF7.1.

TABLE DF7.1 GUTTER SIZES				
Type of gutter	Roof catchment area (m ²)			
	10	20	50	100
	Required cross-sectional area of gutter (mm ²)			
Eaves gutter	1700	2950	6160	10700
Internal box and valley gutter	2020	3510	7310	12730

Notes:

- (1) The roof catchment area is the area of the roof drained by one downpipe. It is taken as the area of the roof from ridge to gutter between two adjacent downpipes.
- (2) Values can be interpolated for catchment areas falling between the given figures.
- (3) The gutter sizes do not include any allowance for freeboard. A freeboard of 25 mm for eaves gutters and 35 mm for internal box gutters must be added to the cross-sections derived from the table. No freeboard allowance need be added to valley gutters.
- (b) Gutters must have a minimum slope of:
- (i) 1 in 500 for eaves gutters; and
 - (ii) 1 in 200 for internal box gutters.

These slopes must be increased where there is any material risk of clogging of the gutters and downpipes with leaves and other such matter.

Note:

With high fronted eaves with fascia boards there could be overflow from the back of the gutter into the building if the downpipes or gutters are blocked. One method of preventing such overflow is by providing drainage slots along the front of the gutter at a level lower than the back edge. Another method would be to provide sumps and weirs at the ends of the gutter or where the downpipes take off. The risk of overflow into the building from any internal box gutter can be reduced by providing sumps and weirs at the ends of the gutter.

DF7.2 Design of downpipes

The minimum area of cross-section of a downpipe must be the greater of:

- (a) half the area of cross-section of the gutter it serves; or
- (b) the area calculated for each 10 m² of the roof area drained by it at the rate of:
 - (i) 650 mm² for eaves gutters; and
 - (ii) 930 mm² for internal box gutters.

DF7.3 Incompatible metals for gutters

Direct contact between the following metals must be avoided in order to prevent corrosion:

Zinc or aluminium	}	{ copper or copper alloys
and	}	{ and
alloys of either	}	{ some grades of stainless steel.

LATRINES FOR AREAS WHERE THERE IS NO PIPED WATER SUPPLY

1. Scope

This Specification sets out the requirements in relation to the location and types of latrines in areas where there is no piped water supply.

2. Precautions

Care must be exercised to ensure that:

- (a) disease transmitting flies and other insects do not have access to the excreta.
- (b) there is no nuisance to the public or the neighbours.
- (c) the sub-soil water is not polluted if it is likely to be used for domestic purposes.
- (d) the biological oxygen demand (BOD) of any resulting effluent is limited to the requirements of the Department of Health so that streams rivers and oceans are not polluted.

3. Location

The latrines must be screened from public view and be located not less than:-

- (a) 30 metres from any well or other similar potable source of water.
- (b) 6 metres from the front or street boundary of the allotment.
- (c) 3 metres from any boundary other than the front or street boundary.
- (d) 3 metres from any dwelling within or outside the allotment.

4. Types of latrines

The following disposal methods can be used

1. Dry on-site treatment: dry pit latrines and composting latrines.
2. Wet on-site treatment: wet pit latrines, aqua privies, septic tanks, and biogas plants.

All these disposal methods rely on the reduction of BOD by aerobic bacteria (where free oxygen is available) and/or anaerobic bacteria (where free oxygen is excluded).

4.1 Composting Latrines (Fig 4.1) are of two types, the single-vault continuous operation type and alternative twin-vault batch systems such as the WHO Vietnamese design.

Continuous-operation types utilize aerobic bacteria to act on excreta and vegetable wastes suspended on a rack above the floor of the ventilated vault. Urine is evaporated off or drained away. As the mixture decomposes, it falls through the rack and is removed for use as fertilizer.

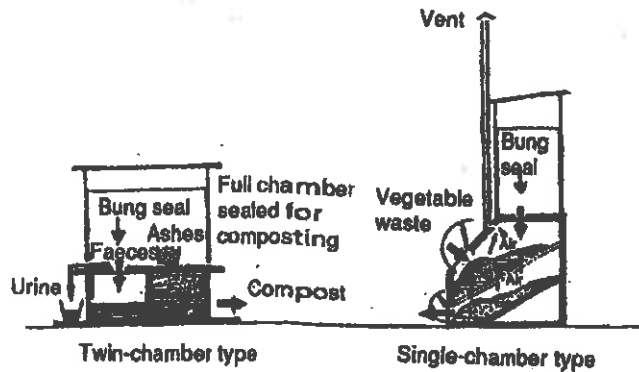

FIGURE 4.1 COMPOSTING LATRINES

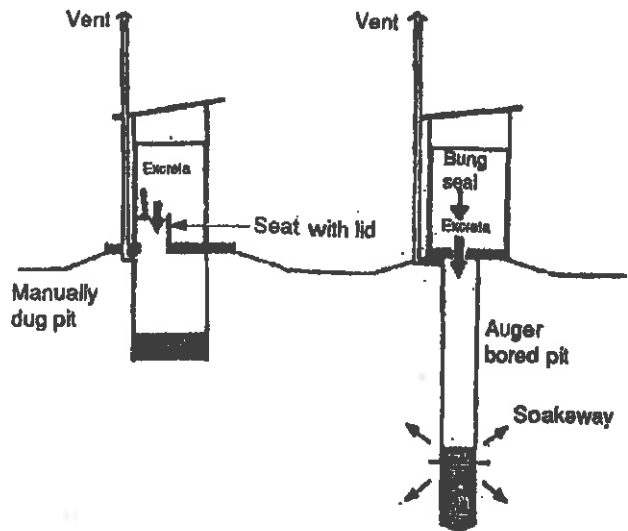

FIGURE 4.2 DRY (NONFLUSH) PIT LATRINES

DF2.1 LATRINES FOR AREAS WHERE THERE IS NO PIPED WATER SUPPLY

In the alternating twin-vault type, one vault at a time receives excreta. Urine is drained away in a separate surface channel. The excreta are covered with loose earth, ashes, or sawdust to reduce odors. When the vault is nearly full, it is sealed with lime mortar and left for a few months to compost by anaerobic bacterial action. Contents are then removed and used for fertilizer. During this time the other vault is used as the latrine. Both types work best in warm climates and with little or no urine-loading.

4.2 Dry Pit Latrines have no flushing facility (Fig 4.2). They are manually dug pits or mechanically bored holes a few meters deep over which a squatting plate with a bung seal or seat with lid is placed. These latrines operate more efficiently when the bottom of the pit is below the water table, which allows excreta to be decomposed by anaerobic bacteria below water level and to soak away into the surrounding ground. However this could lead to the pollution of potable water sources in the area. Gases generated, such as methane, are vented through a tall vent pipe. When pits are dry, a combination of anaerobic and aerobic decomposition takes place. When a pit is almost full, the surface cover is removed and the top of the pit filled with a mixture of lime and earth. A new pit is then dug.

4.3 Wet Pit Latrines are bucket-flushed, water-seal, floor-pan latrines with a soak-away pit in porous soil. Digestion of excreta is by anaerobic bacteria below water level. The lower section of the pit is lined to retain water when the pit does not reach the water table. Gases from the digestion are vented through a tall pipe.

For more details of dry pit and wet pit latrines see Annexure 1 to this Specification.

4.4 Aqua Privies (Fig 4.4) are simplified septic tanks with a single chamber and without a full flush pan. Where bucket-flushed squat plates are used, excreta enters the tank through a short pipe that penetrates below the surface of the liquid in the tank to minimise odours. Alternately,

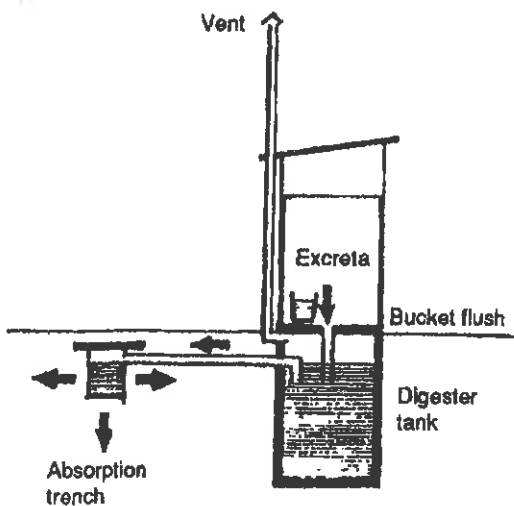

FIGURE 4.4 AQUA PRIVY

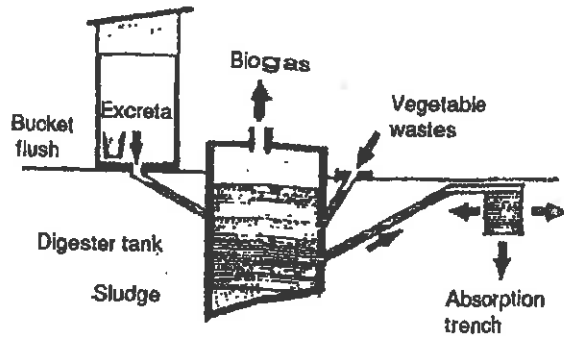

FIGURE 4.6 BIOGAS DIGESTER

excreta may enter through a low-volume, water seal, bucket-flushed floor trap set in the squat plate. Decomposition is by anaerobic bacteria below water level in a permanent tank, which periodically requires desludging. Gases generated in this process of decomposition are vented through a tall vent pipe. Excess effluent from the tank is drained to absorption trenches.

4.5 Septic Tanks can be either single or double chamber. They are generally used with full cistern flush water-seal pans. Single-chamber designs use anaerobic digestion; in double-chamber designs the second chamber is ventilated and uses aerobic bacteria for digestion. The permanent tanks need desludging periodically. The effluent is piped into absorption trenches. For details of septic tanks see Annexure 2 to this Specification.

4.5 Biogas (Gobar Gas) Digestors (Fig 4.6) operate similarly to a single-chamber anaerobic septic tank, but provision is made to trap the gas, which is largely methane, given off during digestion. The methane gas can be used as fuel for cooking and lighting buildings. For efficient gas production, the contents of the digester tank should have a carbon:nitrogen ratio of approximately 30:1. Vegetable wastes are usually added to the excrement to raise the carbon content in the tank. Excess effluent from the tank is often drained into ponds, where algae are grown as feed for domestic animals such as ducks. The digester tank requires desludging periodically.

The choice of latrine is determined by local ground conditions, rainfall, water table, water supply, ground temperature range, and social, cultural, and religious influences within the community.

PIT LATRINES

1 Introduction

Pit latrines can be of two types - dry pit and wet pit.

This specification covers the details of both. When correctly constructed and maintained according to this specification and details available from the Health Department, the nuisance from flies and bad odour could be substantially reduced.

2 Location

Pit latrines whether wet or dry must be located:

- (a) at least 30m away from any well or other potable source of water if the pit does not go through any fissured rock or coral;
- (b) 3 m from any dwelling within or outside the allotment;
- (c) 6 m from any boundary with a street;
- (d) 3 m from boundaries other than with a street;
- (e) preferably at a lower ground than where a potable source of water is located;
- (f) such that it is accessible to the household at all times; and
- (g) so that the prevailing wind around the latrine is not shaded.

Where the pit penetrates through fissured rock or coral through which liquids from the pit might pass unfiltered, the advice of the Health Department must be sought on the location. Otherwise all the fissures must be closed with concrete or cement mortar.

The site must be on firm ground which will not cave in or slump while digging the pit. If there is some problem in this regard, one solution could be to line the affected area with an old drum with both ends removed. The site should not be subject to flooding or remain water-logged.

3 Calculation of dimensions

The pit volume depends on the number of users, the period for which it is used and a freeboard allowance of 0.5 m depth. If the pit remains dry the annual accumulation of sludge is about 0.08 m³/person. In wet pit latrines or where washing water is allowed to enter it, the accumulation rate could be taken as 0.05 m³.

For example, for a family of 5 which plans to use the pit for 5 years, the volume required to hold the sludge would be:

For a dry pit - $5 \times 0.08 \times 5 = 2.0 \text{ m}^3$

For a pit area of 0.6 m x 1.0 m,

the depth required for the sludge = $2.0 / (0.6 \times 1.0) = 3.3 \text{ m}$

Add freeboard allowance = 0.5 m
Total depth required = 3.8 m

For a wet pit, the volume of sludge
= $5 \times 0.05 \times 5 = 1.25 \text{ m}^3$

For a pit diameter of 600mm, area of cross-section
= $0.6 \times 0.6 \times 3.14/4 = 0.28 \text{ m}^2$

Depth of pit for sludge = $1.25 / 0.28 = 4.5 \text{ m}$
Add freeboard = 0.5 m
Total depth = 5.0 m

If these depths are considered impractical either the sectional size of the pit can be slightly increased (for instance, for 700mm diameter the depth of the pit would be 3.8m for a 5 year life) or the depth reduced to cater for a shorter life for the pit.

A cover slab of size 1.4 m x 1.0 m would be appropriate for the dimensions chosen for the dry pit if the sides of the pit are very stable; otherwise the size of the slab must be larger. The pit need not be rectangular in shape. It can be an auger bored circular pit of 600 to 700 mm diameter.

4 Construction

4.1 Digging the pit

The pit may be dug manually in which case it is usually rectangular or square. A power operated or hand auger can be used to dig circular pits. Whichever method is used care must be exercised to ensure that the dimensions at the top remain true. Otherwise there could be difficulty and additional cost in placing the cover slab.

Where it is necessary to close off any fissures or crevices in rock or coral in the pit, the pit dimensions must be sufficient for someone to be lowered down to do the work. Great care must be exercised in lowering anyone. A safety rope must be used and at the first sign of any cave-in or other problem others on top must promptly pull the person from out of the pit. If the fissures are large concrete to a mix of 1 part cement, 2 parts clean sand and 4 parts gravel/coral/stones must be used to close them. If not use cement mortar with 1 part cement and 2 parts sand. The concrete or mortar must be to a stiff mix.

4.2 Foundation

The foundation provides a sealed support for the cover slab and raises it above the surrounding ground. The foundation may be cast in concrete or be made up of concrete block masonry or durable timber. The ground around the pit must be levelled and preferably raised with a layer of gravel, coral or earth before pouring/erecting the foundation.

DF2.1 PIT LATRINES

4.3 Cover slab

Cover slabs are of two types:

- (a) squat type with small platforms for the feet; or
- (b) a pedestal type on which the user can sit.

The cover slab can be purchased from the Health Department or from private suppliers. It could also be locally pre-cast using detailed instructions available from the Department of Health. Figures 4.3 A and B give some details of the cover slab.

The cover slab must be placed over the foundation so that it is fully supported without any gaps. Cement mortar may be used to firmly seat the slab over the foundation. The finished surface of the slab must be at least 150 mm above the immediate surrounds.

4.4 Vent pipe

A 100mm PVC vent pipe may be erected over the pit to remove foul gases generated by the decomposition of the waste matter. The squat slab has a matching PVC insert shown in Figures 4.4A and 4.5 on which the vent pipe can be erected. The vent pipe must be supported to the frame of the shed over the pit. One way of strapping the pipe is also shown in Figure 4.4A. The vent pipe must be at least 2.5 m high and 500 mm above the roof at the point of penetration or the nearest point. The open end of the vent must be covered with durable fly screen to prevent flies and mosquitoes from entering the pit (Figure 4.4B).

Mosquito breeding inside the pit is not a likely problem where a pour-flush water seal is used over the cover slab (see figure 4.3B). In the case of a squat slab a wooden bung seal can be used to cover the squat hole when it is not being used. This would prevent mosquitoes and flies from gaining entry into the pit. In the case of seats without a water seal, a folding lid can be used to keep it covered when it is not in use.

It is good to extend the squat hole or (seat without water seal) into the pit by about 300mm by using an insert. This would reduce the chances of the foul gases escaping through the hole rather than through the vent. (When the restricted space in the shed gets hot from the sun, foul gases would tend to escape through the hole in the slab rather than through the vent).

4.5 The shed

A typical shed is shown in Figure 4.5. Although it could be built of any locally available material, it should be durable and firmly held down. Otherwise it could be blown away during cyclones and act as a wind-borne missile. The shed must afford privacy and have good ventilation. Good ventilation would keep the shed less hot in summer and thereby reduce the chances of foul gases escaping through the hole in the cover slab. The interior of the shed must be shaded from too much light as flies are attracted to light.

5 Maintenance

The pit latrine must be kept clean at all times. However do not use strong disinfectants in large quantities. It is best to use a wet mop or wet rag soaked in diluted disinfectant or cleaning agent to clean the cover slab and seat. If chemicals and cleaning agents are allowed inside the pit, they would drastically affect the bacterial degradation of the waste matter and there could be problems with foul smells and the pit could be filled sooner.

Any erosion of the fill around the foundation must be noted and repaired. The fly screen cover over the vent pipe must also be checked periodically and replaced promptly if damaged. The shed over the pit must be kept in good repair.

6 Pit closure

When the pit is full to within about 0.5 m of the cover slab it must not be used any more. Another pit must be located at least 3 m away (the deeper the pit, the greater the separation distance). The cover slab, vent pipe, and shed can be re-used over the new pit.

The remaining space in the old pit must be filled with earth. It is good to over-fill and form a mound so that enough surplus earth is available when the material subsides with decomposition. The pit can be dug out after a minimum period of one year and the material safely used as a fertiliser.

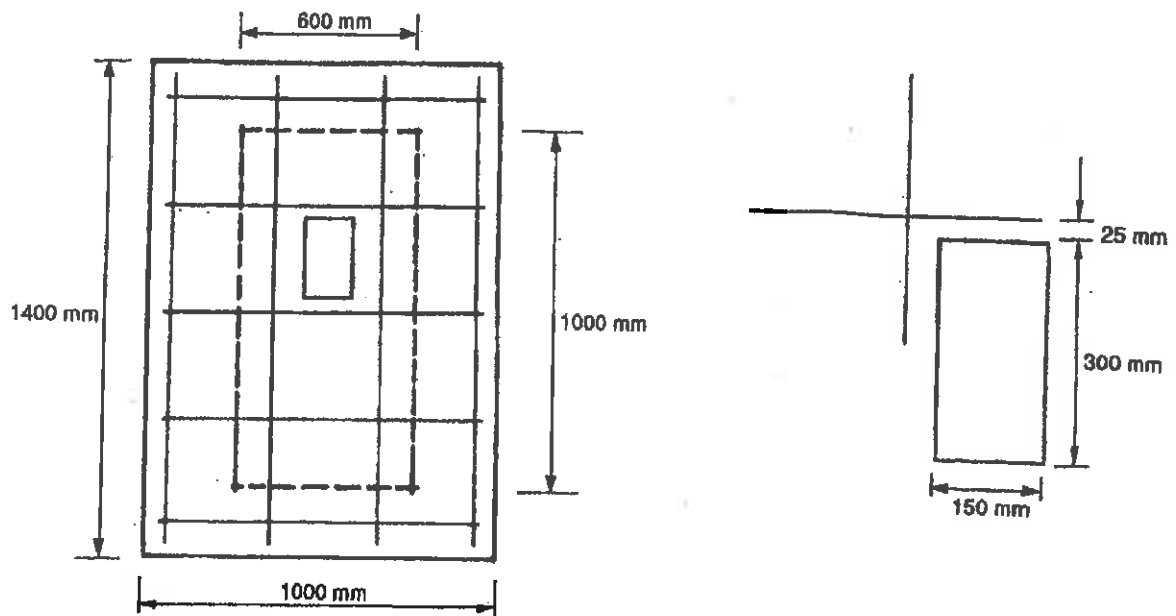

Note: All reinforcement
10 mm bars with 20 mm
cover

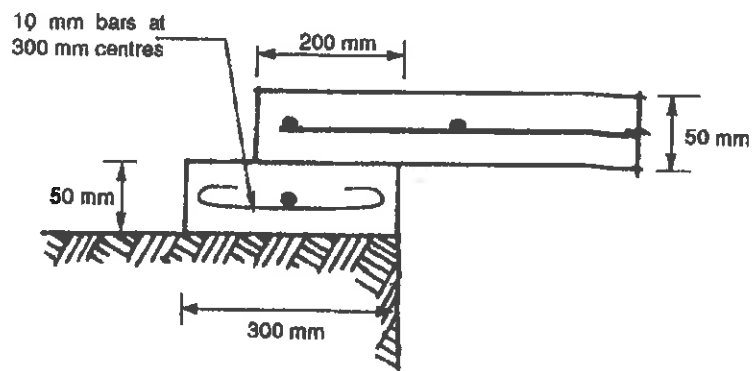

FIGURE 4.3A DETAILS OF SQUAT TYPE COVER SLAB

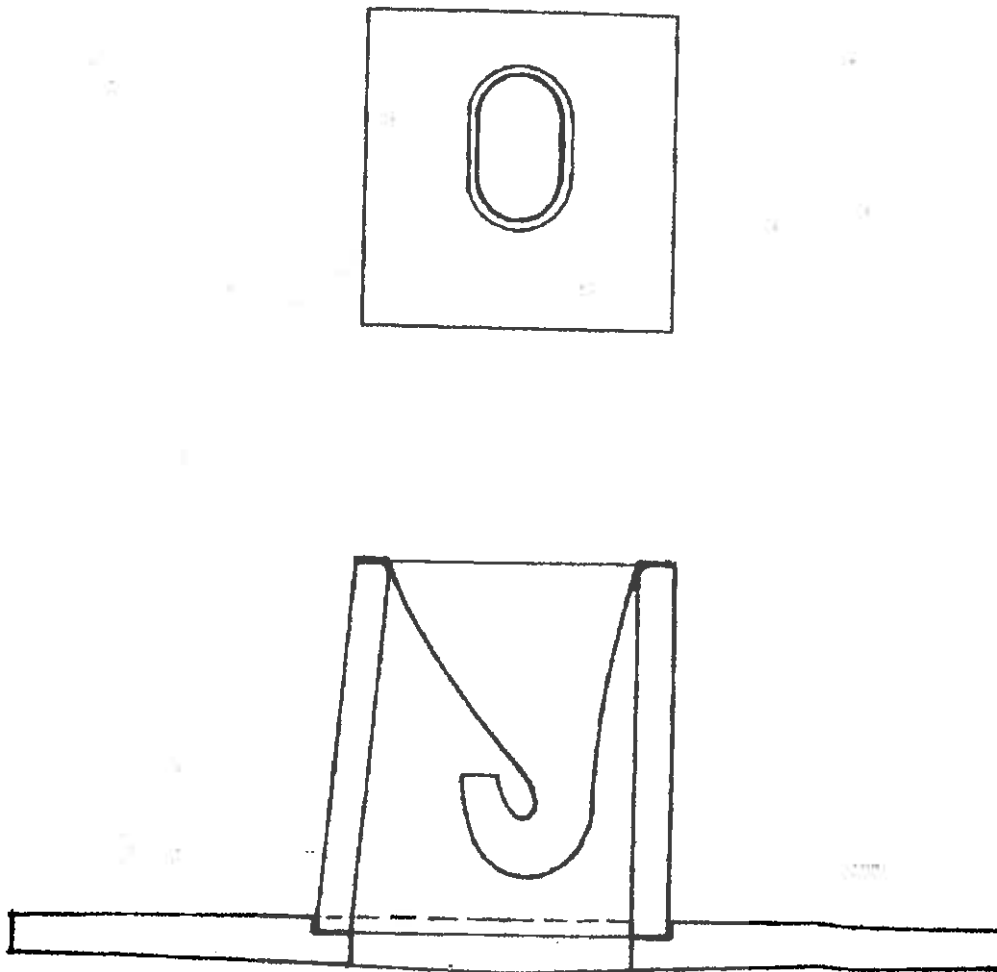

FIGURE 4.3B COVER SLAB WITH POUR-FLUSH WATER SEAL SEAT

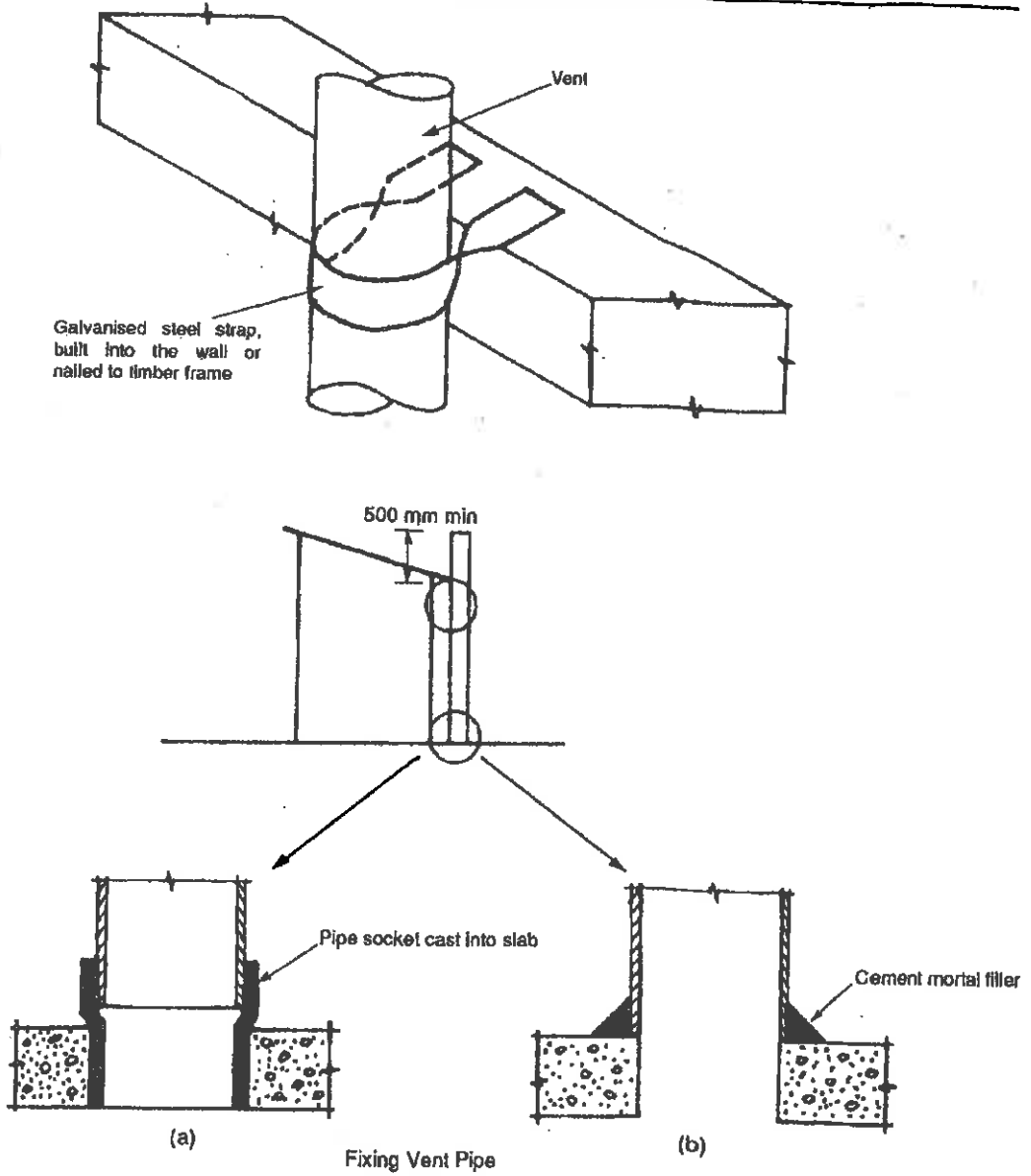

FIGURE 4.4A METHODS OF FIXING THE VENT PIPE

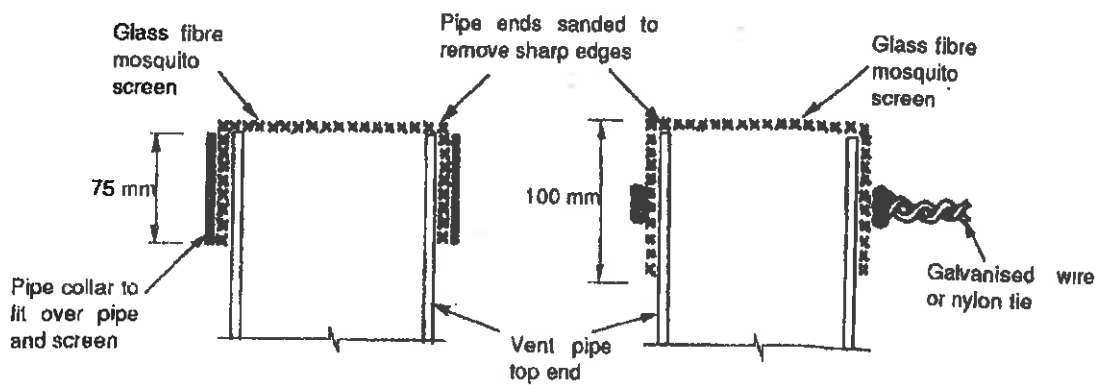

FIGURE 4.4B FIXING OF INSECT SCREEN OVER VENT PIPE

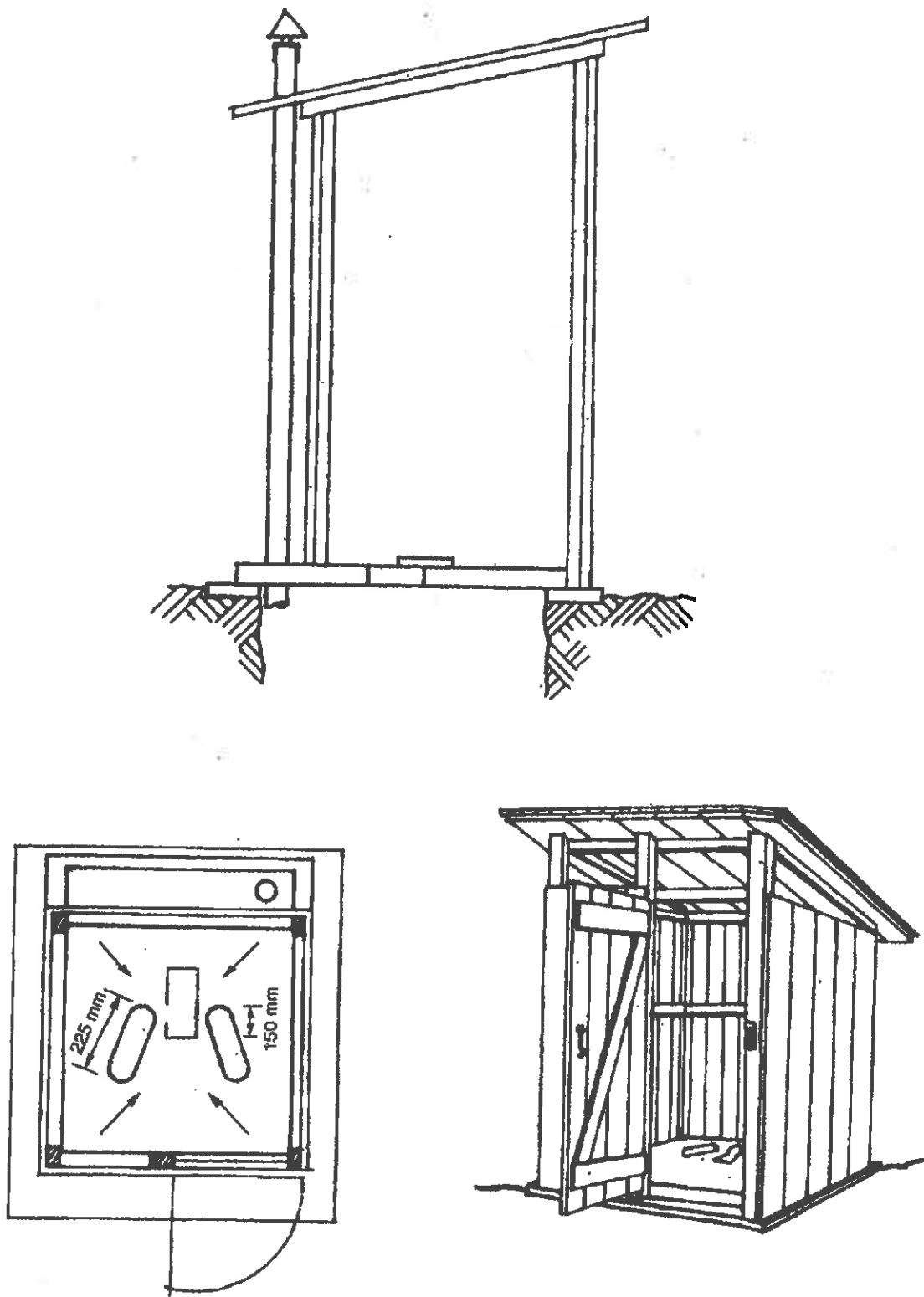

FIGURE 4.5 GENERAL ARRANGEMENT

SEPTIC TANKS FOR DOMESTIC USE

1 Function of a septic tank

The basic function of a household septic tank is to receive normal liquid household wastes and to condition them for such a time, and in such a manner, that the clarified effluent may be percolated efficiently into the subsoil, where it is absorbed and evaporated. In order to perform this basic function, all septic tanks must fulfill the following requirements:

(a) Remove solids

A septic tank must have a primary or liquefying chamber of such shape and size that the rate of flow of all sewage is so reduced that at least the larger solids sink to the bottom and are retained and the clarified effluent is discharged. The inlet and outlet pipes of this primary chamber must be so shaped and located that the scum which forms on the surface of the sewage is not disturbed. The capacity of the tank is usually kept equal to the inflow during 24 hours to allow a day's retention.

(b) Promote bacterial action

To ensure that the solids and liquids in the tank will decompose it is necessary that the tank be designed so that either-

- (i) a variety of bacteria - anaerobic bacteria - which thrive in the absence of free oxygen are present; or
- (ii) a variety of bacteria - aerobic bacteria - which thrive with access to air is also present.

A tank that is designed to achieve the purpose defined in (i) is a single-treatment septic tank, and a tank that is designed to achieve the purpose defined in (ii) is a double-treatment septic tank. A double-treatment tank is generally more expensive. Therefore details of only single-treatment tanks with or without aerobic filters will be included in this Specification.

(c) Store sludge

A fine silt-like sludge accumulates at the base of the primary tank. It follows that the primary tank must be of sufficient size to store sludge for a considerable period; otherwise, if the tank is not cleaned out at frequent intervals, the sludge will eventually be scoured from the tank and clog the outlet drain, the absorption trench or soil and an aerobic filter where provided.

2 Location

Septic tanks and other connected works such as absorption trenches and soak pits must be located at a sufficient distance to prevent contamination of potable water sources and nuisance. Figure 2 shows typical layouts with the minimum separation distances marked on them. It will be seen that a minimum distance of 30 m is required between soak pits and potable water sources whereas this distance is only 15 m in the case of absorption trenches.

Another important consideration in the siting of a septic tank is that an adequately absorbent area must be available for discharging the effluent through absorption trenches or soak pits.

3 Construction

3.1 Septic tanks may be of reinforced concrete or of reinforced block masonry walls over a reinforced concrete base. Tanks of precast concrete construction may be made from rectangular slabs which are assembled on the site, or be of cylindrical construction, either as a single cylinder open at the top, or a stack of short, open-ended cylinders. There are also prefabricated septic tanks made of fibre glass.

3.2 Whatever form of construction or materials are used for the sides and bottoms of septic tanks the resulting work must be impervious to water. For tanks of rectangular section, it is important that all internal angles be well-rounded, so as to minimize shrinkage cracking. Leakage at the corners of tanks of precast concrete construction made from rectangular slabs, or at the joints of precast tanks made from a number of open-ended cylinders, must be detected and corrected in advance.

3.3 Every septic tank of block masonry or concrete construction must be covered with reinforced concrete slabs and removable manhole covers fitted over every compartment. The manholes are used when it is necessary to pump out or otherwise clean the tanks. Inspection openings are also required over the inlet and outlet square junctions. The aerobic filter where provided must be fitted with hard, impervious and durable stone, coral or gravel. These must be graded from 60 mm to 75 mm.

3.4 Design details

The design of the type of septic tank system to be installed will be governed by the results of the investigations of the site and locality, taken in conjunction with the results of the percolation test discussed in clauses 5.2 and 5.3. Where the soil is of a suitable type and is sufficiently absorbent, and where the absorption area is sufficiently large to dispose of the final effluent, a single treatment septic tank

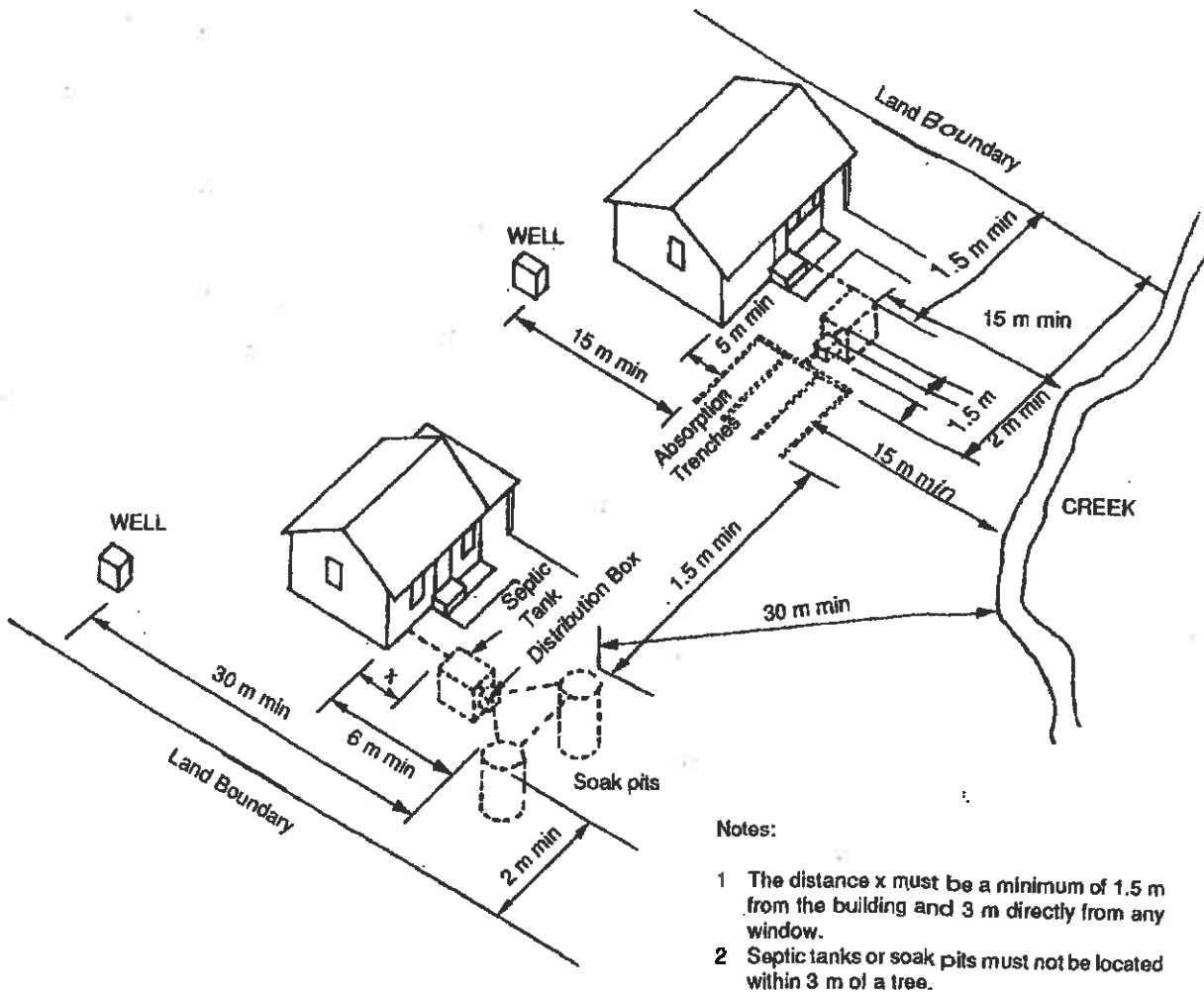

FIGURE 2 TYPICAL LOCATION OF SEPTIC TANK SYSTEMS WITH MINIMUM REQUIRED SEPARATION DISTANCES

will be suitable. If there is any doubt about the porosity of the site and that the effluent might seep on to adjoining premises or public places, then an aerobic filter must be installed with a septic tank. A surface area of one square metre of filtering materials must be provided in aerobic filters for up to every 0.9 m³ of flow of sewage per day. This works out to about 1 m³ of filter for 50 m³ of daily flow of sewage.

Figures 3.4A, B and C and Tables 3.4A and B give details of the dimension required of built-in-situ septic tanks. Table 3.4A also gives the volume of 60-75 mm stones for any aerobic filter that may be provided.

3.5 Figure 3.5 shows an arrangement for aerobic filters. The filter chamber can also serve as a distribution box for the absorption trenches.

4 Grease traps

4.1 The satisfactory disposal of the discharge from kitchen waste fixtures is frequently difficult because it is charged with grease which cannot be satisfactorily dealt with in a septic tank. This difficulty may be overcome by a grease trap located near the kitchen through which all discharge from the kitchen must pass before entering the drain to the septic tank. For satisfactory working of the trap it is necessary that both laundry and roof waters, and liquid and powder detergents, be excluded from it. A grease trap constructed as shown in Fig. 4.1 has been found effective in arresting grease. Alternatively, a smaller precast concrete or other type of grease trap may be installed

The capacity of the grease trap below the level of the invert of the outlet must be not less than the total capacity of the sinks and dishwashers served. The cover over the trap should be removable to facilitate the cleaning of the trap.

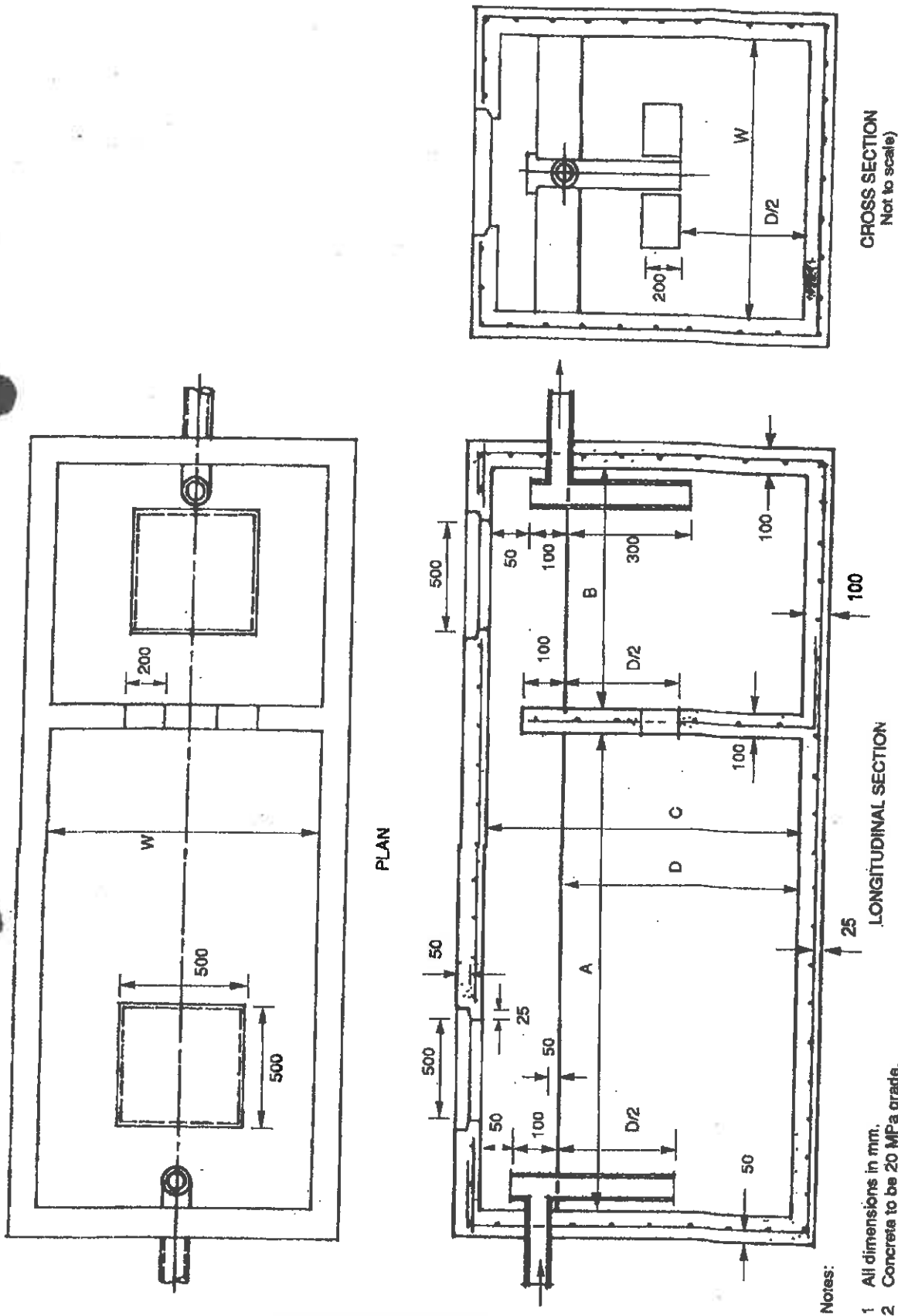
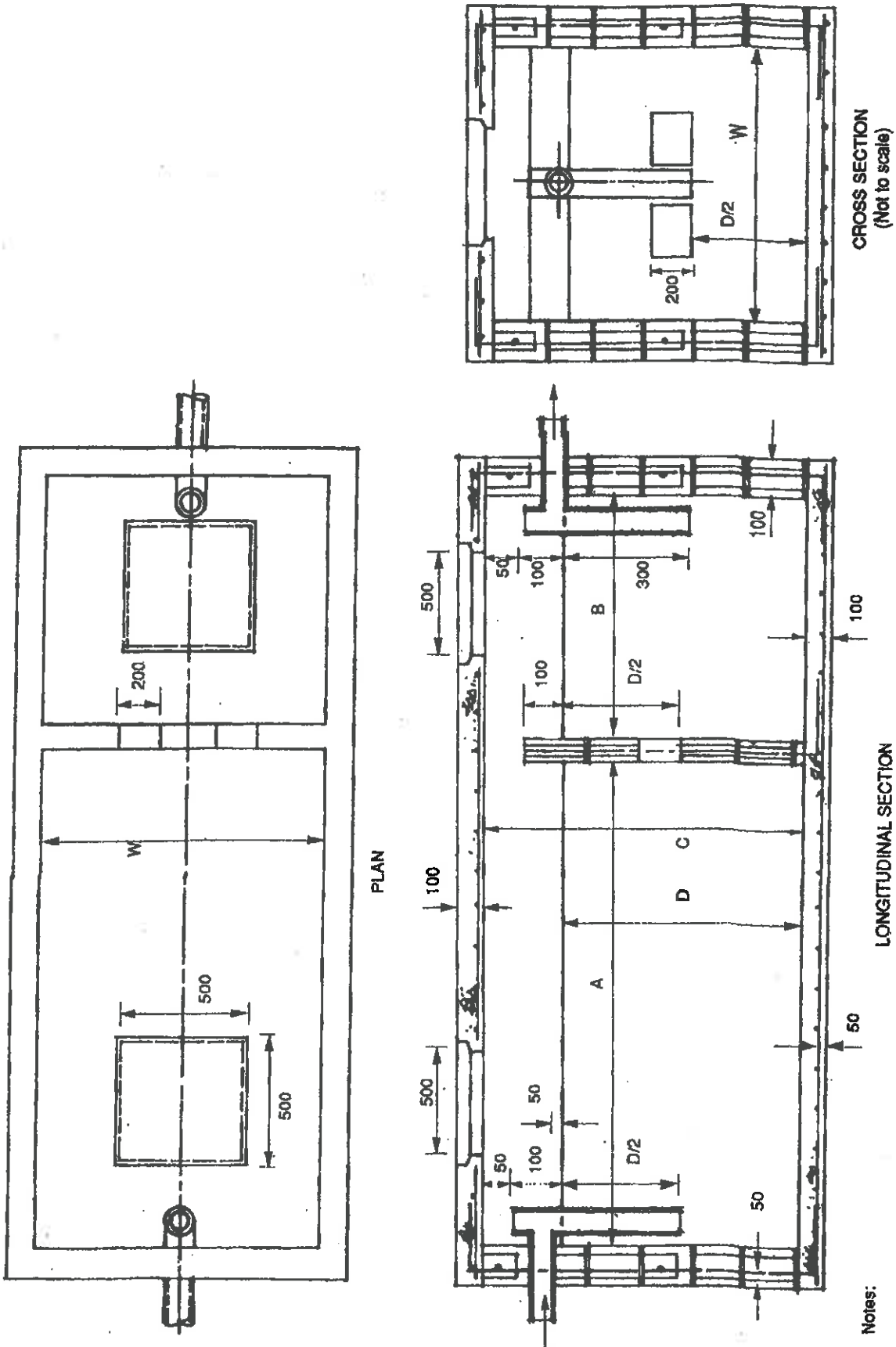

FIGURE 3.4A DETAILS OF REINFORCED CONCRETE SEPTIC TANK



Notes:

- 1 All dimensions in mm.
- 2 Concrete to be 20 MPa grade.
- 3 Reinforcement - 665 mesh or D10 at 250 c/s both ways all around.

FIGURE 3.4B DETAILS OF REINFORCED BLOCK MASONRY SEPTIC TANK

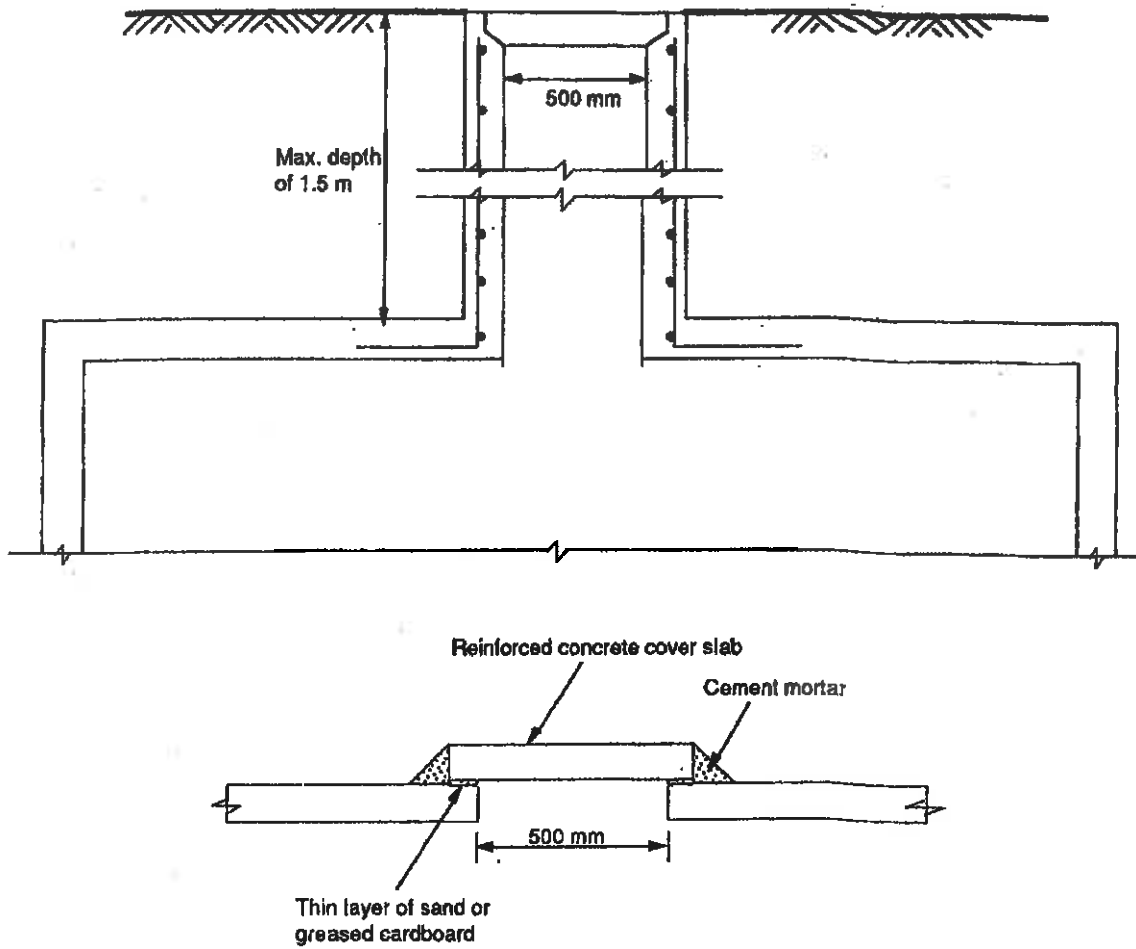

FIGURE 3.4C TWO ALTERNATIVE METHODS OF PROVIDING MANHOLE COVERS

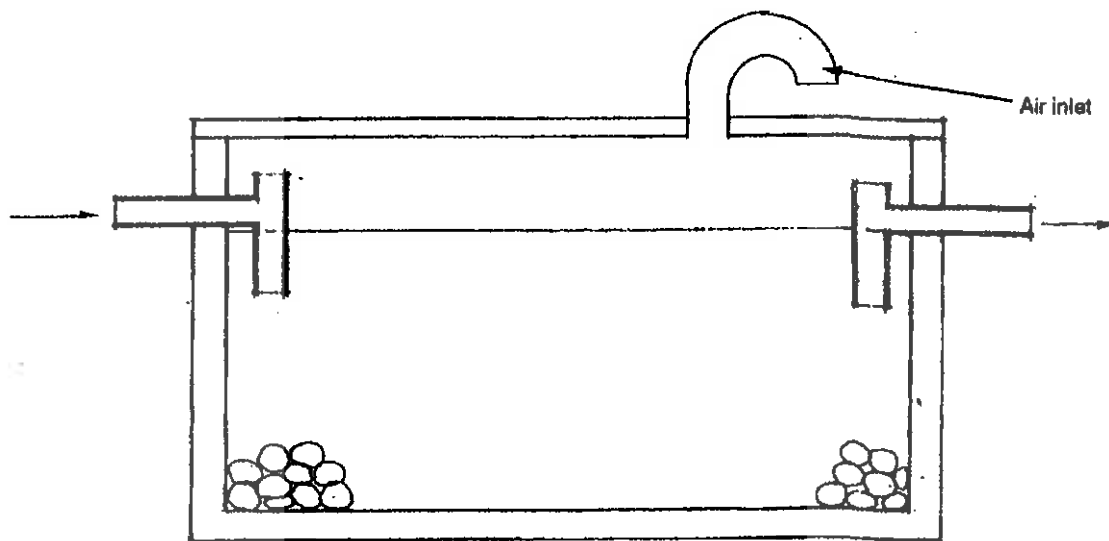

FIGURE 3.5 AEROBIC FILTER

TABLE 3.4A
SEPTIC TANK DIMENSIONS AND VOLUMES OF AEROBIC FILTER

No. of Persons	ONLY SOIL WASTE						
	A	B	C	D	W	V(m ³)	F(m ³)
8	1000	400	1000	850	800	0.95	0.02
10	1000	600	1000	850	800	1.22	0.02
12	1000	600	1000	850	800	1.22	0.02
15	1000	600	1200	1050	800	1.34	0.03
25	1200	800	1200	1050	1000	2.10	0.05
50	1600	800	1400	1250	1000	3.00	0.06
100	2400	1200	1400	1250	1200	5.40	0.11
150	2600	1400	1600	1450	1400	8.12	0.16
200	3000	1600	1600	1450	1600	10.67	0.21
300	3400	1800	1800	1650	1800	15.44	0.31
400	4000	2200	1800	1650	2000	20.46	0.41
500	4200	2200	1800	1650	2400	25.34	0.51
600	4400	2400	2000	1850	2400	30.19	0.61

No. of Persons	ALL DOMESTIC WASTE						
	A	B	C	D	W	V(m ³)	F(m ³)
8	1400	800	1000	850	1000	1.87	0.04
10	1400	800	1200	1050	1000	2.31	0.05
12	1800	800	1200	1050	1000	2.73	0.06
15	1800	800	1200	1050	1200	3.28	0.07
25	2000	1200	1400	1250	1400	5.80	0.11
50	3200	1600	1600	1450	1600	11.14	0.22
100	4000	2000	1800	1650	2200	21.78	0.44
150	5000	2400	2000	1850	2400	32.86	0.66
200	5600	2400	2000	1850	3000	44.40	0.89
300	6600	3400	2000	1850	3600	66.60	1.33
400	8000	4000	2000	1850	4000	88.80	1.78
500	8200	4200	2000	1850	4800	110.11	2.20
600	9000	4800	4000	1850	5200	132.76	2.66

V = Volume of Septic Tank; F = Volume of Aerobic Filter; For details of A, B, C, D and W see Figures 3, 4A and B

TABLE 3.4 B
REINFORCEMENT FOR MASONRY SEPTIC TANKS

Block wall thickness	Height of Tank (m)	Vertical bars	Horizontal bars
150	1.0	D10 @ 600	D12 @ 600
	1.2	D12 @ 600	D12 @ 600
	1.4	D12 @ 400	D12 @ 600
200	1.6	D12 @ 400	D12 @ 600
	1.8	D16 @ 600	D12 @ 600
	2.0	D12 @ 400 fill all cells	D16 @ 600

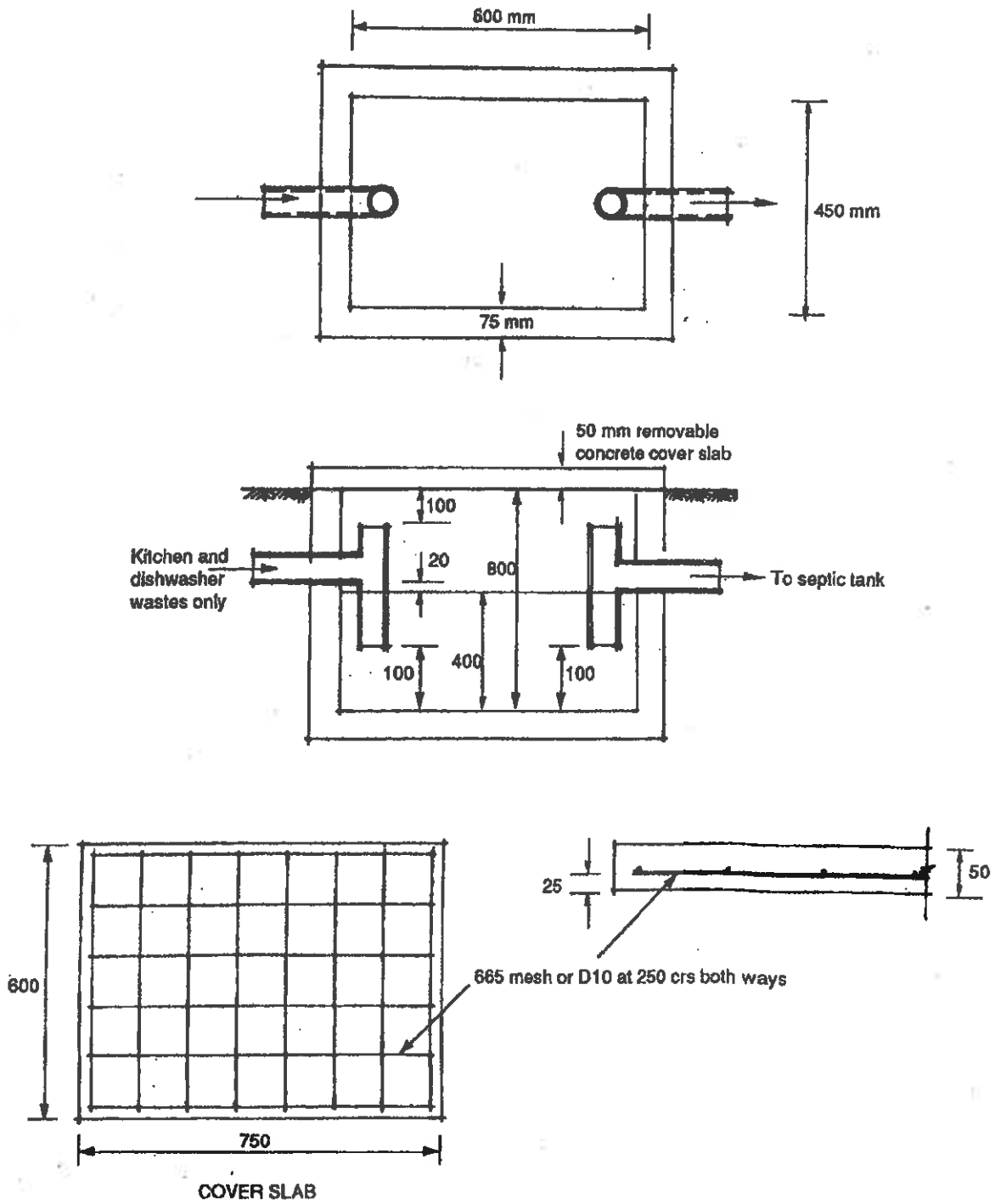

Notes:

- 1 All dimensions in mm.
- 2 Concrete to be 20 MPa grade
- 3 Reinforcement - 665 mesh or D10 at 250 crs both ways all around.

FIGURE 4.1 DETAILS OF A GREASE TRAP

4.2 If grease traps are not regularly cleared of the accumulated grease it would give rise to the blocking of drains, unsightly overflow through the sides of the cover slab of the trap and unpleasant odour.

5 Effluent absorption area

5.1 An important factor when considering the installation of a septic tank is to determine whether the soil is suitable to absorb the effluent, and whether the soil is of adequate depth and area. Generally, it can be said that the most suitable soil for an absorption area is a sandy or silty loam, and the most unsuitable soil, hard impervious clay, or rock. Where an impervious stratum such as rock or clay is present, it may not be possible to provide an absorption trench. If the slope of the ground allows the provision of imported absorbent fill of sufficient thickness, it will still be possible to have a trench or soak pit.

5.2 The absorption rate of the soil may be ascertained by carrying out the following percolation test:

At a number of representative spots within the area to be used for installation of the absorption drains, dig holes 300 mm square to the depth of the absorption drain. Pour water into the holes to a depth of 150 mm or more, and allow the water to soak away. Again pour water into the holes to a depth of 150 mm and record the times taken for the surface of the water to fall 25 mm.

5.3 The recommended dosage of effluent in litres per metre of absorption trench per day, according to the time taken for the water surface to fall 25 mm in the test is given in Table 5.3, and the minimum length of the absorption trench in metres may be determined from the formula at the base of the Table.

TABLE 5.3
LENGTH OF ABSORPTION TRENCH FOR DIFFERENT
ABSORPTION RATES

Time for water level in test to fall by 25 mm (minutes)	Dosage of effluent in litres per metre of trench per day (E)
1	75
2	60
5	45
10	30
20	18
30	15
60	11

NOTES:

- (a) Length of absorption trench in metres = $1000 \sqrt{V/E}$, Where V is the volume given in cubic meters in Table 3.4A.
- (b) If the time taken for a fall in level of 25 mm is more than 60 minutes the soil is not suited for absorption trench method of disposal.

6 Absorption trenches

6.1 Typical dimensions for an absorption trench are approximately, width 450 mm and minimum depth of 400 mm. The trenches are packed with 75 mm size hard stone, gravel or coral to a height of 150 mm, over which a line of perforated pipes is laid along the centre of the trench, commencing about 300 mm from the beginning of the trench and thereafter running the full length of the trench. The drain pipe conveying the effluent to the trench extends into the trench and butts against the first perforated pipe.

6.2 The joints between the pipes in the trench must not be sealed. The pipes should be surrounded and covered with 75 mm broken hard stone or hard coral to within a few millimetres from the top of the trench, over which should be placed a protective covering of old iron, bag, bark or the like, before covering the trench with soil or turf.

6.3 The absorption trench may also be constructed of concrete slabs laid in such a manner that there are many vertical joints left open so as to allow the effluent to escape. Concrete slabs are used to cover the top of the trench, and these may themselves be covered by soil or turf.

6.4 The absorption trench should be constructed along the general contour of the ground. It must be so positioned that the prepared ground level at the trench is lower than the invert of the outlet pipe from the septic tank so as to prevent the effluent back-flooding into the septic tank. Typical absorption trenches are shown in Fig. 6.4 A and their general layout in Fig 6.4 B.

6.5 Moisture-seeking shrubs or other vegetation planted in the vicinity of the trench will assist in the absorption of the effluent, but care should be taken in selecting the shrubs so that their roots are not likely to interfere with the efficiency of the trench. Roof water, and as far as possible surface and ground water, must be excluded from absorption trenches, so as to maintain their efficiency.

7 Soak pits

Where sufficient area for absorption trenches is not available, but there is sufficient depth of absorbent material, soak pits may be used. A typical arrangement is shown in Figure 7. Old bitumen drums with the ends removed are shown arranged in tiers. The drums are pierced at about 200 mm centres with a pick or so. They are surrounded by 75 mm hard stone, gravel or coral. The effluent is drained into the drums. The minimum thickness of stone surrounding the drums must be 300 mm. The actual dimensions of the soak pit will depend on the nature of the soil and the volume of effluent.

In general a soak pit is not as effective or desirable a means of disposal as absorption trenches.

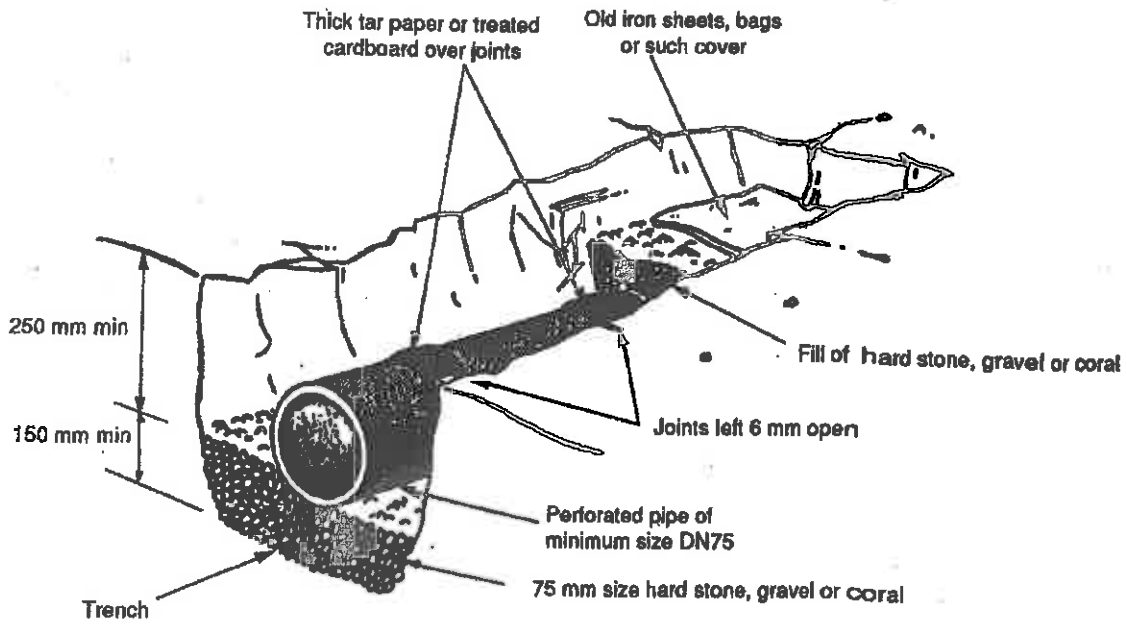

FIGURE 6.4A EXAMPLE OF AN ABSORPTION TRENCH

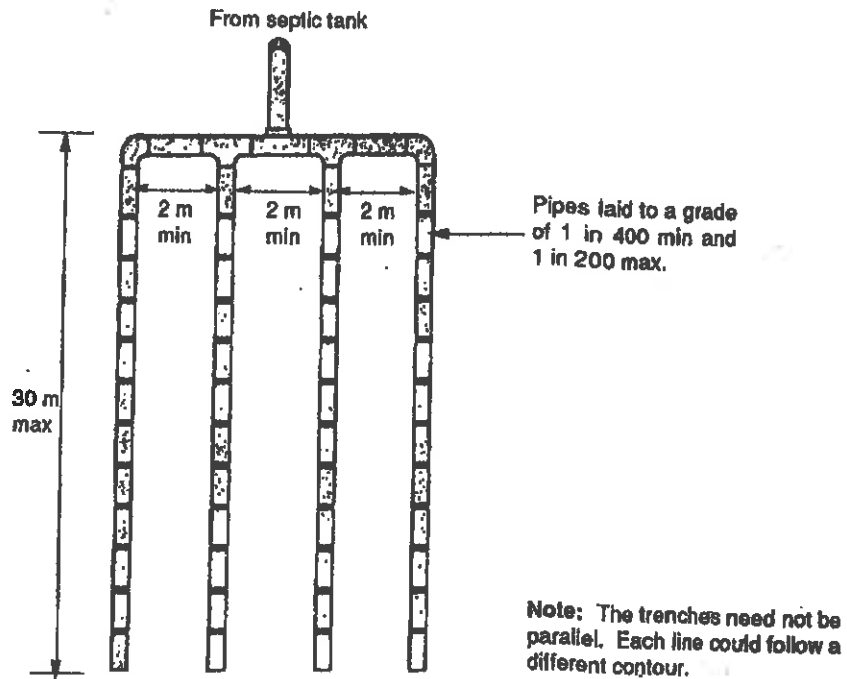

FIGURE 6.4B GENERAL LAYOUT OF ABSORPTION TRENCH

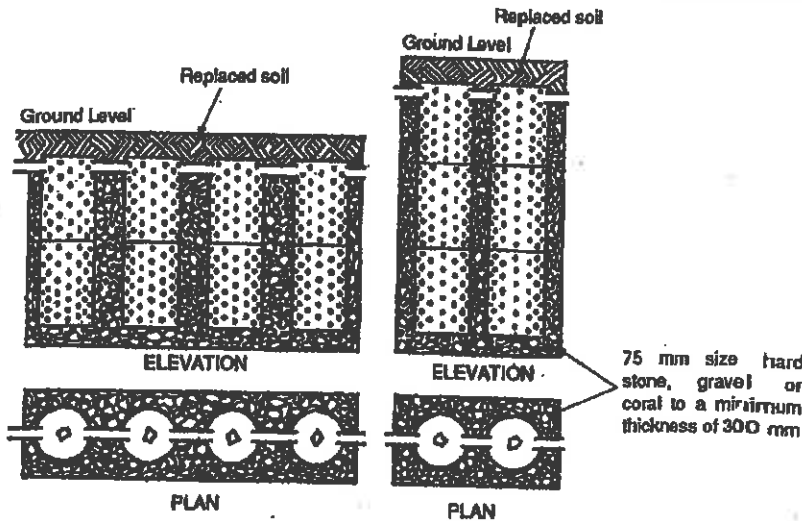

FIGURE 7 TWO ARRANGEMENTS OF DRUMS USED IN SOAK PITS

8 Special circumstances

8.1 Site conditions can necessitate the adoption of special measures, such as:

- (a) Importation of suitable soil and its retention to act as an absorption area. Alternatively, it may be necessary for wastes from the kitchen, laundry and bathroom to by-pass the septic tank and be absorbed in an area away from that used to absorb the effluent from the septic tank.
- (b) It may be necessary to construct a number of trenches as a grid, to distribute the effluent over as wide an area as possible. A distributor may be incorporated in the effluent-drain system, to direct the effluent to any desired trench. Typical examples of distribution boxes are shown in figure 8.1.
- (c) On some sites it may be necessary to locate the absorption area up-hill from the septic tank, and to install an electric pump. The pump is operated by a float switch and automatically pumps the effluent up

to the absorption trench when the effluent in the tank reaches a nominated level. The cost of installing and maintaining such a pump should be considered.

- (d) In some areas where there are many septic tanks, a drainage system can be made available to take the effluent away from each septic tank, either by gravity or by pumping, to an absorption area, public sewerage, or treatment ponds.

9 Vents

A vent is required in order to allow ventilation through the septic tank and drainage system. Vents are usually of PVC capable of withstanding ultra violet radiation, and are normally taken off at the head of the house drain farthest away from the septic tank. At various stages in the operation of a septic tank, offensive odours may be given off. The height and location of the vent outlet must be a minimum of 150 mm above its point of penetration through any roof covering and 600 mm above the top of any opening situated within a radius of 3 m from the vent.

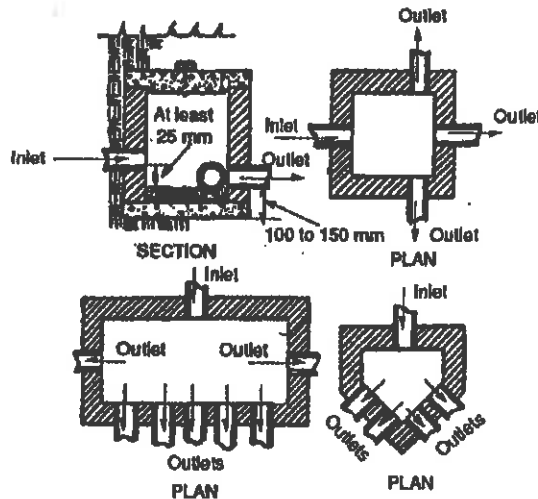

FIGURE 8.1 EXAMPLES OF DISTRIBUTION BOXES

RAINWATER STORAGE

1. Introduction

Rainwater collection from the roof depends on a number of factors. Unless these are suitably matched the supply would not be satisfactory. The factors are:

- (a) the average annual rainfall and its variability through the year;
- (b) the roofing material and the available area of the roof;
- (c) the daily rate of consumption of water;
- (d) the storage volume and the material of the tank; and
- (e) the desired reliability of the supply.

2. Relationship of rainfall, its variability, roof area and storage volume

The higher the average annual rainfall, the smaller the collection area of roof required for a given rate of consumption. In order to allow for variation in actual rainfall from the monthly averages, it is advisable to have the available roof area to be twice the theoretical area.

If the pattern of rainfall is fairly uniform through the year, the size of storage tank for a given rate of consumption would be relatively smaller. The tank size could be as small as to hold 50 days consumption where rainfall is quite uniform through the year. Where most (such as 75%) of the annual rainfall occurs in 3 or 4 months it will be necessary to size the tank to hold 100 to 120 days of consumption. This assumes that the available roof collection area is twice the theoretical area. Where the available roof area is less than about 1.4 times the theoretical area, the required storage volume tends to increase very steeply. The size of the tank determined from these considerations should normally give an average reliability of supply with a failure rate of about once every 5 years. If an average chance of failure of supply of once a year is acceptable, the calculated tank size can be reduced by about 30% in areas of high rainfall and by 40% in areas of lower rainfall.

3. Design

The theoretical relationship outlined in para 2 can be expressed as:

$$A = 365 \times C/R \text{ where}$$

A is the roof area acting as the catchment in square metres,

C, the daily average consumption of water by the household in litres, and

R, the average annual rainfall in millimetres

However, for the reasons stated earlier the practical value of the roof catchment is:

$$A = 2 \times 365 \times C/R = 730 C/R$$

In order to assess the size of the storage tanks Fiji has been divided into 2 categories - areas with a more uniform spread of rainfall and those with rainfall concentrated over 3 or 4 months of the year. In the case of the areas with a more uniform rainfall, it is estimated that a storage capacity of 80 days consumption would be adequate to provide a reasonably reliable supply with the risk of failure of only once in 5 years. For a similar level of reliability in areas with an uneven spread rainfall, the estimated storage is equal to 100 days consumption.

Taking a family size of 5 members, each consuming no more than 30 litres per day of the stored water, the minimum roof area and storage capacity required in representative regions in Fiji have been calculated for the average rainfall in those regions. These are shown in Table 3. If the family size and/or daily consumption is different, the required roof area and tank size can easily be calculated from the Table.

**TABLE 3
MINIMUM ROOF AREA AND TANK CAPACITY FOR
RAINWATER COLLECTION**

Total tank capacity of 15 kilolitres (3400 gallons)		Total tank capacity of 12 kilolitres (2700 gallons)	
Minimum roof catchment to drain into storage (m ²)			
64	50	40	30
Sigatoka/Nadi	Ba	Suva/Nausori	Navua
Lautoka	Vanua Levu	Rakiraki	Monasavu
Lau group	Kadavu	Taveuni	Rotuma
Yasawa group			

Example: If the family size considered in say, Rotuma is 7 and the daily consumption per head is 20 litres, the required roof catchment = $30 \times 20 \times 7 / (30 \times 5) = 28 \text{ m}^2$
Tank size = $12 \times 20 \times 7 / (30 \times 5) = 11.2 \text{ kilolitres (2500 gallons)}$

Note: If a risk of failure of supply once a year is acceptable, the tank size can be reduced by 30%.

4. Effect of roofing material and the environment

Rainwater in general is very pure and hence many metals dissolve in it much faster than in land based water. For instance if any lead is used in the roof for flashing or in the form of lead-based paint, the rainwater would leach the lead into the storage tank. If this happened, the water would not be potable. The nature of the materials used in the roof must be ascertained and their safety confirmed before a decision is taken to use the run-off from the roof. In general galvanised iron sheets, zinc-aluminium coated sheets and a number of other products are safe.

As far as possible leaves and twigs must not be allowed to fall on the roof. The leached extracts from some leaves would make the water unfit for consumption. In addition the organic matter from leaves and twigs would encourage the growth of micro-organisms in the tank, thereby polluting the water. Accumulation of any dust on the roof, such as from industrial activity nearby would also make the water unfit.

5. Tank material

Tanks are generally made of galvanised or zinc-aluminium coated steel plates and sometimes of fibre glass. Whereas suitable fibre glass would be inert and therefore not affected by the rainwater, galvanised steel could. The greater the purity of the stored water, the greater the risk of the galvanising getting leached out very fast. If the roofing sheets are of galvanised steel, the stored water would already contain some of the zinc from the roofing material and hence the tank would last longer. This is not the case where the roofing is of zinc-aluminium coated or painted steel or of some other man-made material.

In order to prevent the corrosive effects of pure rainwater on the tank coating, suitably formulated metaphosphates are commercially available. These produce a protective film inside the tank and thus extend the life of metal coated

tanks. Such methods must be used from the very first filling of the tank. There are also plastic protective coatings compatible with potability which are applied to metal tanks. The inside of the tank must not be painted with any ordinary paint.

In no case must lead be used in any form such as in sheets for flashing or as paint etc on roofs from which water is collected.

6. Erection of rainwater tanks

It is best to erect the tank in a shady location but away from falling leaves which could clog the strainer, and in the case of translucent material like fibre glass, have a dark colour to exclude light. Organic growth could develop on the sides of tanks in the presence of light and warmth. When the tank is part empty the organic growth would decay and give off gases, discolour the water, and produce corrosive acids. The absorption of the gases and acids could also give the water an unpleasant flavour.

The overflow pipes fitted to tanks for the disposal of excess inflow of rainwater must be adequate to prevent uncontrolled overflow. Such pipes must not terminate very close to storm water drains and soak pits as otherwise unpleasant gases might enter the tank. The pipe end and all openings to the tank must be fitted with strong, durable mesh to prevent birds, mosquitoes and other insects gaining entry into the tank.

No copper pipe should be used with any metal water tank. The inlet pipe must discharge the water through a durable strainer fitted well above the high water level. The inlet must not be close to the tank wall. Where tanks are interconnected each tank must receive at least some of the water directly from the roof. No tank must get its supply entirely from other tanks. It is convenient to have individual domestic tanks of no greater capacity than 4 or 5 kilolitres (1000 gallons).

**NATIONAL
BUILDING
CODE
1990**

DWELLINGS AND OUTBUILDINGS (CLASS 1 AND 10)

SECTION DG

ANCILLARY PROVISIONS

**Performance Requirements
Deemed-to-Satisfy Provisions**

DG1 Minor Structures and Components

DG2 Fireplaces, Chimneys and Flues

CONTENTS

PERFORMANCE REQUIREMENTS

DEEMED-TO-SATISFY PROVISIONS

Part

Part

DG1 Minor Structures and Components

DG2 Fireplaces, Chimneys and Flues

DG1.1 Swimming pools

DG2.1 General requirements

DG1.2 Poultry and other Domestic Animal Houses

DG2.2 Open fireplaces deemed-to-satisfy

DG1.3 Fences

PERFORMANCE REQUIREMENTS

OBJECTIVES AND REQUIRED PERFORMANCE

This Section contains more specific requirements for particular parts of Class 1 and 10 buildings.

Parts of buildings and structures must be so designed and constructed that the following requirements in addition to those listed for Sections B, DC, and DF where relevant, are fulfilled.

DGP1 Minor Structures and Components

DGP1.1 Swimming pools-

- (a) Suitable means for the disposal of waste and drainage must be provided to a *swimming pool*.
- (b) Access by unsupervised young children to *swimming pools* must be restricted.

DGP1.2 Aesthetics

Any minor structure such as fencing awnings and the like must be suited to the general surroundings as well as the occupancy of the building and the neighbourhood.

DGP1.3 Animal houses

Accommodation for animals and poultry must not lead to unsanitary conditions for the occupier or neighbours and the public. The accommodation must be such that the animals or poultry are not subjected to serious discomfort or overcrowding.

DGP2 Fireplaces, Chimneys and Flues

Fireplaces, chimneys and flues must be adequately constructed or separated to prevent-

- (a) ignition of nearby parts of the building; or
- (b) escape or discharge of smoke to the inside of the building or to adjacent *windows, ventilation inlets, or the like*.

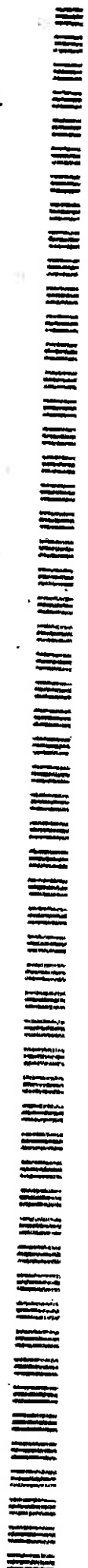

DEEMED-TO-SATISFY PROVISIONS

MINOR STRUCTURES AND COMPONENTS

DG1.1 Swimming pools

- (a) **Drainage:** A *swimming pool* must have suitable means of drainage.
- (b) **Safety fencing:** A *swimming pool* with a depth of water more than 300 mm must have suitable barriers or safety fencing in accordance with AS 2818 and AS 1926 to restrict access by young children-
- (i) to the allotment or the immediate pool surrounds if there is only one Class 1 building on the allotment; or
 - (ii) to the immediate pool surrounds if the *swimming pool* is associated with a number of Class 1 buildings on the same allotment.

DG1.2 Poultry and other Domestic Animal Houses

A building used for keeping domestic birds or animals must be not less than:

- (a) 12 m from any Class 1 building;

- (b) 10 m from any boundary ; and
- (c) 20 m from the boundary adjoining an allotment containing or intended to contain any building other than a Class 1 building.

The floor of the building must be constructed of suitable material. Suitable arrangements must be made for the collection and disposal of animal wastes, so that they do not create a nuisance or encourage the breeding of flies and other pests. The size and general arrangements in the building must be conducive to the welfare of the poultry or animals.

DG1.3 Fences

Any fencing or free standing wall must be suited to the occupancy of the building within. It must not detract from the general aesthetic appearance of the surroundings. If any barbed wire or other such is used it must be at a height of not less than 2 m above the finished level of any existing or intended adjacent footpath.

FIREPLACES, CHIMNEYS AND FLUES

DG2.1 General requirements

A chimney or flue must be constructed-

- (a) to withstand the temperatures likely to be generated by the appliance to which it is connected;
- (b) so that the temperature of the exposed faces will not exceed a level that would cause damage to nearby parts of the building;
- (c) so that hot products of combustion will not-
 - (i) escape through the walls of the chimney or flue; or
 - (ii) discharge in a position that will cause fire to spread to nearby *combustible* materials or allow smoke to penetrate through nearby-*windows*, ventilation inlets, or the like;
- (d) in such a manner as to prevent rainwater penetrating to any part of the interior of the building;
- (e) such that its termination is not less than:
 - (i) 600 mm above any point of penetration of or contact with the roof; and
 - (ii) 900 above any opening or openable part in any building, which is within 3 m horizontal distance of the chimney or flue; and
- (f) so that it is accessible for cleaning.

DG2.2 Open fireplaces deemed-to-satisfy

An open fireplace, or solid-fuel burning appliance in which the fuel-burning compartment is not enclosed, satisfies DG2.1 if it has-

- (a) a hearth constructed of stone, concrete, masonry or similar *non-combustible* material so that-
 - (i) it extends not less than 300 mm beyond the front of the fireplace opening and not less than 150 mm beyond each side of that opening;
 - (ii) it extends beyond the limits of the fireplace or appliance not less than 300 mm if the fireplace or appliance is free-standing from any wall of the room;
 - (iii) its upper surface does not slope away from the grate or appliance; and
 - (iv) *combustible* material situated below the hearth (but not below that part required to extend beyond the fireplace opening or the limits of the fireplace) is not less than 155 mm from the upper surface of the hearth;
- (b) walls forming the sides and back of the fireplace up to not less than 300 mm above the underside of the arch or lintel which-
 - (i) are constructed in 2 separate leaves of solid masonry not less than 180 mm thick, excluding any cavity; and
 - (ii) do not consist of concrete block masonry in the construction of the inner leaf;
- (c) walls of the chimney above the level referred to in (b)-
 - (i) constructed of masonry units with a net volume, excluding cored and similar holes, not less than 75% of their gross volume, measured on the overall rectangular shape of the units, and with an actual thickness of not less than 90 mm; and
 - (ii) lined internally to a thickness of not less than 12 mm with rendering consisting of 1 part cement, 3 parts lime, and 10 parts sand by volume, or other suitable material; and
- (d) suitable damp-proof courses or flashing to maintain weatherproofing.

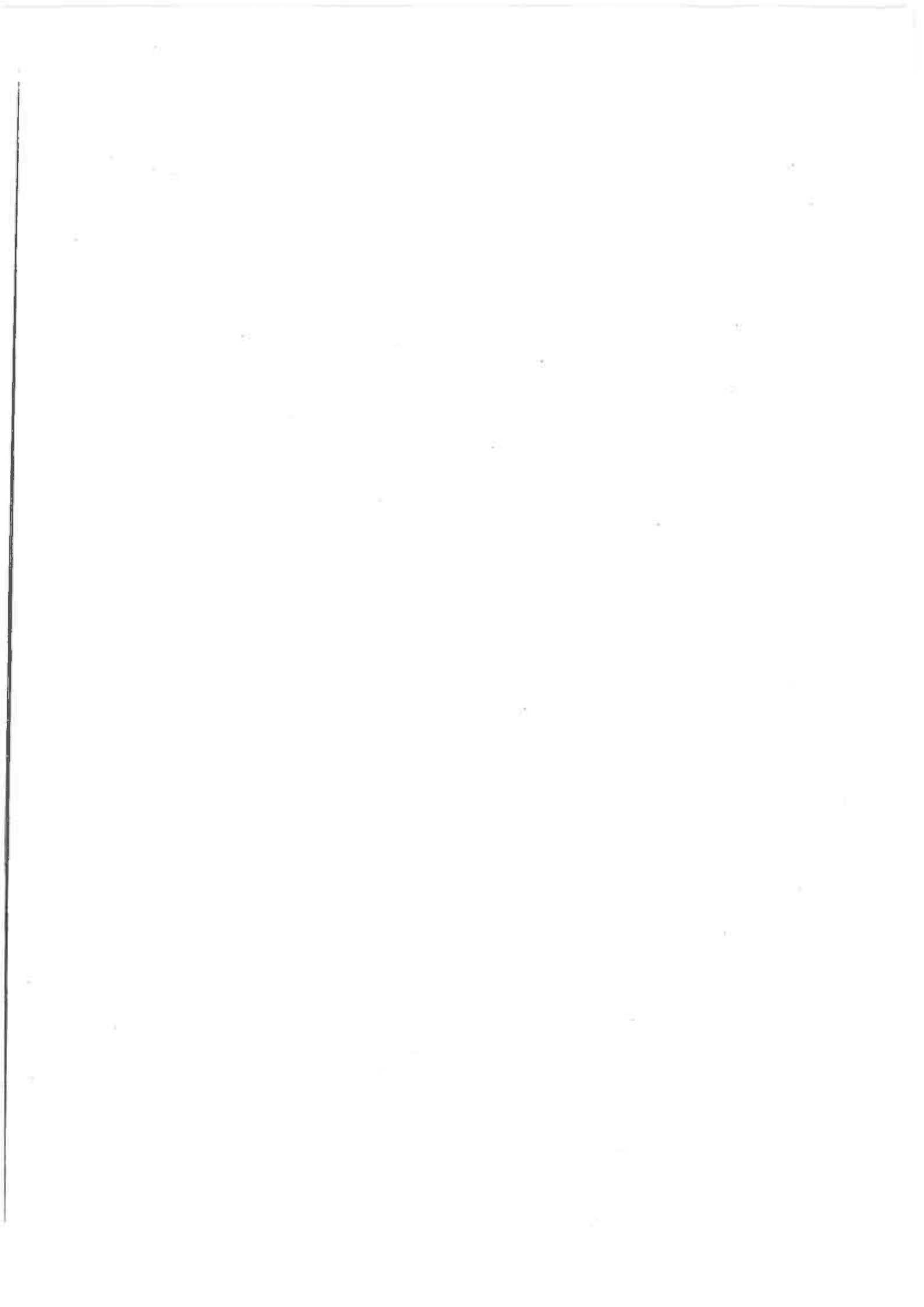

NATIONAL
BUILDING
CODE
1990

PUBLIC BUILDINGS AND GROUP DWELLINGS (CLASS 2 TO 9)

SECTION **NC**

FIRE RESISTANCE

**Performance Requirements
Deemed-to-Satisfy Provisions**

- NC1 Fire Resistance and Stability**
- NC2 Compartmentation and Separation**
- NC3 Protection of Openings**

CONTENTS

PERFORMANCE REQUIREMENTS

DEEMED-TO-SATISFY PROVISIONS

Part	Part
NC1 Fire Resistance and Stability	NC3.4 Acceptable methods of protection
NC1.1 Type of construction required	NC3.5 Doorways in fire walls
NC1.2 Calculation of rise in storeys	NC3.6 Sliding fire doors
NC1.3 Mixed Types of construction	NC3.7 Protection of doorways in horizontal exits
NC1.4 Open spectator stands and indoor sports stadiums	NC3.8 Openings in fire-isolated exits
NC1.5 Lightweight construction	NC3.9 Service penetrations in fire-isolated exits
NC1.6 Early Fire Hazard indices	NC3.10 Openings in fire-isolated lift shafts
NC2 Compartmentation and Separation	NC3.11 Bounding construction: Class 2, 3 and 4 buildings
NC2.1 Application	NC3.12 Openings in floors for services
NC2.2 General floor area limitations	NC3.13 Openings in shafts
NC2.3 Large isolated buildings	NC3.14 Openings for service installations
NC2.4 Requirements for open spaces and vehicular access	NC3.15 Installation deemed-to-satisfy
NC2.5 Class 9a buildings	
NC2.6 Separation of openings in external walls	Specifications
NC2.7 Separation by fire walls	Specification NC1.1 Fire-Resisting Construction
NC2.8 Separation of classifications in the same storey	Specification NC1.5 Structural Tests for Lightweight Construction
NC2.9 Separation of classifications in different storeys	Specification NC1.6 Early Fire Hazard Indices
NC2.10 Separation of lift shafts	Specification NC3.4 Fire Doors, Smoke Doors, Fire Windows and Shutters
NC2.11 Stairways and lifts in one shaft	Specification NC3.15 Penetration of Walls, Floors and Ceilings by Services
NC2.12 Separation of equipment	
NC2.13 Electricity substations	
NC3 Protection of Openings	
NC3.1 Application of Part	
NC3.2 Protection of openings in external walls	
NC3.3 Separation of openings in different fire compartments	

PERFORMANCE REQUIREMENTS

OBJECTIVES

The design and construction of buildings must fulfill the following objectives -

NCP1 Fire Resistance and Stability

- (a) A building must be constructed so that it is protected from fire in any other building.
- (b) Materials used in the construction must be such that if there is a fire in the building -
 - (i) the spread of fire and the generation of smoke and toxic gases will be minimised;
 - (ii) stability will be maintained for a period at least sufficient for the occupants to escape and to ensure the safety of fire-fighters; and
 - (iii) there will be little risk of collapse onto adjoining property.

NCP2 Compartmentation and Separation

Buildings must be constructed to localise the effects of fire to the areas of origin. Adequate levels of passive fire protection must be provided so that sufficient time is available for the users and others to escape from the effects of fire and as an alternative, to allow the users to stay safely within unaffected compartments for the duration reasonably required to put out the fire by active means.

NCP3 Protection of Openings

Openings must be protected and service penetrations must be fire-stopped to maintain separation and compartmentation.

REQUIRED PERFORMANCE

NCP 1.1 In order to maintain the structural adequacy and stability of any building for a sufficient time for the safety of the users fire lighters and others, the following must be ensured -

- (a) the loadbearing elements must have the FRL appropriate to their function in the building, the expected fire load density, the fire risk, the height of the building, its location with reference to the availability of external fire fighting resources, and the fire control measures available within the building;
- (b) the FRL of structural elements must be at least equal to that of other elements to which they provide support; and
- (c) the collapse of elements with a lower FRL must not result in the collapse of elements with a higher FRL.

NCP2.1 The size of a fire compartment must also be consistent with the fire severity of the fire load density it contains and the likely spread of fire between it and any other compartment, storey or building.

Building compartment size and separating construction must be such that the potential size of a fire and the spread of fire and smoke are limited in order to -

- (a) protect the occupants of one part of a building from the effects of fire elsewhere in the building;
- (b) control the spread of fire or smoke to adjoining buildings; and
- (c) facilitate access to the building by fire-fighters.

NCP 3.1 Openings of any nature in the envelope surrounding fire compartments must be so protected that they do not allow the passage of dangerous amounts of heat, flames, smoke and gases in the event of a fire within or outside the compartment and for a period sufficient to -

- (a) allow the safe evacuation of all affected people; and
- (b) allow fire fighters to fight the fire.

The sufficiency of the duration allowed must take into account the nature of occupancy of the building as well as the proximity of other buildings and their occupancy.

DEEMED-TO-SATISFY PROVISIONS

FIRE RESISTANCE AND STABILITY

NC1.1 Type of construction required

- (a) The minimum Type of *fire-resisting construction* of a building must be that give in Table NC1.1, except as allowed for -
- (i) *open spectator stands* and indoor sports stadiums in NC1.4; and
- (ii) *lightweight construction* in NC1.5
- (b) Type A construction is the most fire-resistant and Type C the least fire-resistant of the Types of construction.

(ii) 2 storeys in any other case; and

- (b) a storey is not counted if-
- (i) it is situated at the top of the building and contains only service units or equipment; or
- (ii) it is situated partly below the finished ground and the underside of the ceilings is not more than 1 m above the average finished level of the ground at the *external wall*, or if the *external wall* is more than 12 m long, the average for the 12 m part where the ground is lowest.

TABLE NC1.1
TYPE OF CONSTRUCTION REQUIRED

RISE (in storeys)	CLASS OF BUILDING OR PART								
	2	3	4	5	6	7	8	9	
5 OR MORE	A	A	A	A	A	A	A	A	
3 or 4	B	B	B	B	B	B	B	B	
1 or 2	C	C	C	C	C	C	C	C	

Note:

1. See Specification NC1.1 for details of Types A, B and C construction.

NC1.2 Calculation of rise in storeys

In calculating the *rise* in storeys-

- (a) a *storey* that has an average internal height of more than 6 m is counted as-
- (i) *one storey* if it is the only *storey* above the ground; or

NC1.3 Mixed Types of construction

A building may be of mixed Types of construction if no part of the building is supported by, or vertically over, a part of less *fire-resisting Type*.

NC1.4 Open spectator stands and indoor sports stadiums

An *open spectator stand* or indoor sports stadium which has only changing rooms, sanitary facilities or the like below the tiered seating, need not comply with the other provisions of this Part if it contains not more than 1 tier of seating and is of Type C and *non-combustible construction*.

NC1.5 Lightweight construction

Lightweight construction must comply with Specification NC1.5 if it is used in construction which is *required* to be *fire-resisting*.

NC1.6 Early Fire Hazard Indices

The Early Fire Hazard Indices of materials and assemblies inside Class 2 to 9 buildings must comply with Specification NC1.6.

COMPARTMENTATION AND SEPARATION

NC2.1 Application

This Part does not apply to an *open-deck carpark* or *open spectator stand*.

NC2.2 General floor area limitations

- (a) The size of any *fire compartment* in a Class 5, 6, 7, 8 or 9b building must not exceed the relevant maximum *floor area* and volume set out in Table NC2.2 except as permitted in NC2.3.
- (b) A part of a building which contains only heating, ventilating, or lift equipment, water tanks, or similar service units is not counted in the *floor area* or volume of a *fire compartment* if it is situated at the top of the building.

**TABLE NC2.2
MAXIMUM SIZE OF FIRE COMPARTMENTS**

	TYPE OF CONSTRUCTION OF BUILDING		
	Type A	Type B	Type C
CLASS 5,6, 7, 8 or 9b:	max floor area - 2000 m ² max volume - 12000 m ³	1500 m ² 9000 m ³	1000 m ² 6000 m ³

Note: Subject to the requirements of table NE1.6 and if fully protected with a *sprinkler system* and water supply to NZS 4541 these areas and volumes of the *fire compartment* can be increased to a maximum of -

- (i) 8 times where the *sprinkler system* has two independent water supplies to Class A; and
- (ii) Where the *sprinkler system* has a single water supply to Class C,
- 2000 m² in Class 2, 3 and 5 with a *rise* of no more than 4 *storeys*
 - 4 times in all other classes.

NC2.3 Large isolated buildings of Class 5,6,7,8 or 9b

The *floor area* of a *fire compartment* in a large isolated building may exceed that specified in Table NC2.2 to the following limits and conditions-

- (a) Up to 18000 m² if -
- (i) the building is Class 7 or 8, it contains not more than 2 *storeys* and an *open space* complying with NC2.4(a) not less than 18 m wide is provided around the building; or

- (ii) the building is of any Class and is protected throughout with a *sprinkler system* and perimeter vehicular access complying with NC2.4(b) is provided.

- (b) More than 18000 m² if -

- (i) the building is protected throughout with a *sprinkler system* and perimeter vehicular access complying with NC2.4(b) is provided;

- (ii) if the ceiling height of the *fire compartment* is not more than 12 m, it has a smoke exhaust system in accordance with specification NE2.6 or smoke-and-heat vents and the space below the roof is divided into compartments in accordance with AS 2665; and

- (iii) if the ceiling height is more than 12 m, it has a smoke exhaust system in accordance with Specification NE2.6.

- (c) If more than one building is on the allotment -

- (i) each building complies with (a) or (b); or

- (ii) if the buildings are closer than 6 m to each other and no building is more than 45 m from the required vehicular access, they are regarded as one building and collectively comply with (a) or (b).

NC2.4 Requirements for open spaces and vehicular access

- (a) An *open space* required by NC2.3 must -

- (i) be wholly within the allotment except as in (ii);

- (ii) include vehicular access in accordance with (b);

- (iii) be next to the boundaries of the allotment, and may include any road, river, or public place adjoining the allotment;

- (iv) not be used for the storage or processing of materials; and

- (v) not be built upon, except for guard houses and service structures (such as substations and pump houses) which may encroach upon the width of the space if they do not unduly impede fire-fighting at any part of the perimeter of the allotment or unduly add to the risk of spread of fire to any building on an adjoining allotment.

- (b) The vehicular access *required* by this Part-
- (i) must be capable of providing emergency vehicle access and passage from the public road;
 - (ii) must have a minimum unobstructed width of 6 m and in no part be built upon or used for any purpose other than vehicular or pedestrian movement;
 - (iii) may be substituted by a public road if the building faces and is accessible from the road, and is no further than 45 m from it;
 - (iv) must be such that reasonable pedestrian access from the vehicular access to the building is available; and
 - (v) must be of adequate load bearing capacity and unobstructed height to permit the operation and passage of Fire Brigade vehicles.

NC2.5 Class 9a buildings

The building must be divided into *fire compartments* with a maximum *floor area* of 1700 m² and further -

- (a) *Ward areas* must be subdivided with walls of minimum FRL of 60/60/60 into *floor areas* of not more than 850 m² and again subdivided into parts of 425 m² maximum *floor area* with smoke proof walls complying with (c);
- (b) other than *ward areas* must be subdivided into parts with a maximum *floor area* of 425 m² with smoke proof walls complying with (c);
- (c) a wall *required* to be smoke-proof must -
 - (i) be *non-combustible* and extend to the underside of the floor above or of the roof covering;
 - (ii) only have doorways which are fitted with smoke doors complying with Specification NC3.4 and which do not extend higher than 800 mm from the underside of an imperforate roof covering, floor or ceiling above it; and
 - (iii) not incorporate any other opening which is not smoke-proof; and
- (d) *Fire compartments* must be separated from the remainder of the building by *fire walls* and -
 - (i) in Type A construction - floors and roof or ceiling as *required* in Specification NC1.1;
 - (ii) in Type B construction - floors with a FRL of not less than 90/90/90, and if fully protected with a *sprinkler system* of 60/60/60; and

- (iii) in Type C construction - floors with a FRL of not less than 60/60/60.

NC2.6 Separation of Openings in external walls

In any building which is other than -

- fully protected with a *sprinkler system*;
- an *open deck car park*; or
- of one or two *storeys* rise,

if any part of a *window* or other opening in an *external wall* (except openings in the same stairway) is situated above another opening in the *storey* next below, the opening must be protected by -

- (a) a slab or other horizontal construction that-
 - (i) projects outwards from the external face of the wall not less than 1100 mm;
 - (ii) extends along the wall not less than 450 mm beyond the openings concerned; and
 - (iii) is non-combustible and has a FRL of not less than 60/60/60; or
- (b) a spandrel which -
 - (i) is not less than 1100 mm in height;
 - (ii) extends not less than 600 mm above the upper surface of the intervening floor; and
 - (iii) is of *non-combustible* material having a FRL not less than 60/60/60; or
- (c) providing the *window* or opening in the upper *storey* with a glazing system with a FRL of not less than -/60/30. Any gap in the construction which separates the two *storeys* must be packed with a *non-combustible* material that will withstand the relative thermal or structural movements of the walling and glazing without loss of seal.

Note: These requirements are separate from the structural requirements for glazing at B1.3 and B1.4.

NC2.7 Separation by fire walls

A part of a building separated from the remainder of the building by a *fire wall* is treated as a separate building if -

- (a) the *fire wall* -
 - (i) extends through all *storeys* and spaces in the nature of *storeys* that are common to that part and any adjoining part of the building;
 - (ii) is carried through to the underside of the roof covering; and

NC2 COMPARTMENTATION AND SEPARATION

(iii) has the relevant FRL prescribed by Specification NC1.1 for each of the adjoining parts, and if these are different, the greater FRL;

(b) any openings in a *fire wall* comply with Part NC3;

(c) timber purlins or other *combustible* material do not pass through or cross the *fire wall*; and

(d) where the roof of one of the adjoining parts is lower than the roof of the other part, the *fire wall* extends to the underside of-

(i) the covering of the higher roof, or not less than 6 m above the covering of the lower roof;

(ii) the lower roof if it has a FRL not less than that of the *fire wall* and no openings closer than 3 m to any wall above the lower roof;

(iii) the lower roof if its covering is *non-combustible* and the lower part has a *sprinkler system*; or

(iv) the design of the building must otherwise restrict the spread of fire from the lower part to the higher part.

NC2.8 Separation of classifications in the same storey

If a building has parts of different classifications located alongside one another in the same *storey* -

(a) each building element in that *storey* must have the higher FRL prescribed in Specification NC1.1 for that element for the classifications concerned; or

(b) the parts must be separated in that *storey* by a *fire wall* with whichever is the greater of the higher FRL prescribed in Specification NC1.1 for the classifications concerned.

NC2.9 Separation of classifications in different storeys

If parts of different classification are situated one above the other in adjoining *storeys* they must be separated as follows:

(a) Type A or B construction - The floor between the adjoining parts must have a FRL not less than that prescribed in Specification NC1.1 for the classification of the lower *storey*.

(b) Type C construction - The underside of the floor (including the sides and underside of any floor beams) must have a *fire-protective covering*.

NC2.10 Separation of lift shafts

Any lift (other than if wholly in an *atrium*) must be separated from the remainder of the building by enclosure in a *shaft* with its FRL as prescribed by specification NC1.1 if it connects more than -

(a) Two *storeys* in an unsprinklered building; or

(b) Three *storeys* in a sprinklered building.

The openings for the lift landing doors and services must be protected in accordance with Part NC3.

NC2.11 Stairways and lifts in one shaft

A stairway and lift must not be in the same *shaft* if either the stairway or the lift is *required* to be in a *fire-resisting shaft*.

NC2.12 Separation of equipment

A wall having a FRL of not less than 60/60/60 must bound a room housing equipment comprising -

(a) lift motors and lift control panels;

(b) the main electrical switchboard in a building with an *effective height* of more than 25 m;

(c) *required* stair pressurizing equipment; or

(d) boilers, emergency batteries, emergency generators or central smoke control plant, except -

(i) equipment located in a separate *storey* (or in the topmost *storey*) and separated from the remainder of the building by floor construction having a FRL of 60/60/60;

(ii) smoke control exhaust fans located in the air stream if they are constructed for high temperature operation in accordance with Specification NE2.6; or

(iii) equipment that is otherwise adequately separated from the remainder of the building.

NC2.13 Electricity substations

If an electricity substation is situated within a building

(a) it must be separated from any other part of the building by construction having a FRL of not less than 120/120/120;

(b) doors windows and any other openings on an *external wall* need not have a FRL if such openings are no closer to a *fire source feature* or *exit* than 3 m. Any other doorways including those opening to any other part of the building must be protected with *self-closing* - 120/60 fire doors;

- (c) electricity supply cables between a main and the substation, and between the substation and the main switchboard, must be enclosed or otherwise protected by construction having a FRL of not less than 120/120/120; and
- (d) any openings, fans or grilles for natural or mechanical ventilation must be located only on an external wall unless protected with an automatic -/120/60 fire shutter.
-

PROTECTION OF OPENINGS

NC3.1 Application of Part

- (a) This Part does not apply to -
- (i) control joints, weep holes, and the like, in masonry construction, and joints between pre-cast concrete panels, if they are not larger than necessary for the purpose; or
 - (ii) non-combustible ventilators for sub-floor or cavity ventilation, if each does not exceed 45x10° mm² in face area and is spaced not less than 2 m from any other ventilator in the same wall.
- (b) This Part applies to openings in building elements required to be fire-resisting, including doorways, windows (including any associated fanlight or infill panel) and other fixed or openable glazed areas that do not have the required FRL.

NC3.2 Protection of openings in external walls

Openings in an external wall that is required to have a FRL must -

- (a) be not less distant from a fire-source feature to which it is exposed than -
- (i) 1 m in a building not more than 1 storey in rise; or
 - (ii) 1.5 m in a building more than 1 storey in rise;
- (b) be protected in accordance with NC3.4 if it is situated closer from a fire-source feature to which it is exposed than -
- (i) 3 m from a side or rear boundary of the allotment;
 - (ii) 6 m from the far boundary of a road adjoining the allotment; or
 - (iii) 6 m from another building on the allotment that is not Class 10; and
- (c) if required to be protected under (b), not occupy more than 1/3 of the area of the external wall of the storey in which it is located unless -
- (i) they are in a Class 9b building used as an open spectator stand; or
 - (ii) they face a public road and are located in a storey at ground level.

NC3.3 Separation of openings in different fire compartments

Unless they are protected in accordance with NC3.4, the distance between openings in external walls in compartments separated by a fire wall must not be less than that set out in Table NC3.3.

**TABLE NC3.3
DISTANCE BETWEEN OPENINGS IN DIFFERENT COMPARTMENTS**

ANGLE BETWEEN WALLS	MINIMUM DISTANCE BETWEEN OPENINGS
0° (walls opposite)	6 m
more than 0° to 45°	5 m
more than 45° to 90°	4 m
more than 90° to 135°	3 m
more than 135° to 180°	2 m

NC3.4 Acceptable methods of protection

- (a) Where protection is required, doorways, windows, and other openings must be fitted with suitable -
- (i) Doorways - - /60/30 self-closing or automatic fire doors and fire shutters;
 - (ii) Windows - - /60/30 fire windows (automatic or permanently fixed in the closed position) or - /60/30 automatic fire shutters;
 - (iii) Other openings - construction having a FRL not less than - /60/30;
- These methods of protection may be replaced with specifically engineered external drenchers provided an adequate supply of water can be ensured.
- (b) Fire doors, smoke doors, fire windows and fire shutters satisfy (a) if they comply with Specification NC3.4.

NC3.5 Doorways in fire walls

The aggregate width of openings for doorways in a fire wall which are not part of a horizontal exit must not exceed 1/2 of the length of the fire wall, and each doorway must be protected by -

- (a) Two fire doors or fire shutters, one on each side of the doorway, each of which -
- (i) has a FRL of not less than 1/2 that *required* by Specification NC1.1 for the *fire wall*; and
 - (ii) is *self-closing* unless provided with an *automatic* release mechanism for any hold-open device which will close the door upon actuation of any of the fire/smoke detection systems installed on both sides of the *fire wall*;
- (b) a fire door on one side and a fire shutter on the other side of the doorway, each of which complies with (a); or
- (c) a single fire door or a non metallic fire shutter, which-
- (i) has a FRL of not less than that *required* by Specification NC1.1 for the *fire wall*; and
 - (ii) is *self-closing* unless provided with an *automatic* release mechanism for any hold-open device which will close the door upon actuation of any of the fire/smoke detection systems installed on both sides of the *fire wall*.

NC3.6 Sliding fire doors

If a doorway in a *fire wall* is fitted with a sliding fire door which is open when the building is in use -

- (a) it must be held open with a fusible link, or an electromagnetic device which when de-activated, allows the door to be fully closed not less than 20 seconds, and not more than 30 seconds, after release; and
- (b) thermal or smoke detectors as appropriate must be installed on each side of the doorway, in accordance with NZS 4232; and
- (c) an audible warning device located near the doorway and a red flashing warning light of a suitable intensity on each side of the doorway must be activated when a *required* detector or *sprinkler system* in the part of the building served by the door is activated; and
- (d) signs must be installed on each side of the doorway located directly over the opening stating -

"WARNING - SLIDING FIRE DOOR"

in capital letters not less than 50 mm high in a colour contrasting with the background.

NC3.7 Protection of doorways in horizontal exits

A doorway that is part of a *horizontal exit* must be protected-

- (a) in a Class 7 or 8 building - by 2 fire doors, one on

each side of the doorway, each with a FRL of not less than 1/2 that *required* by Specification NC1.1 for the *fire wall*; or

- (b) in all classes of buildings, by a single fire door which has a FRL of not less than that *required* by Specification NC1.1 for the *fire wall*,

and each door must be *self-closing*, or provided with *automatic* release of any hold-open device upon detection of smoke or fire.

NC3.8 Openings in fire-isolated exits

- (a) A doorway that does not open to a road or open space must be protected by a *self-closing* or *automatic* -/60/30 fire door if it opens to a *fire-isolated* stairway, *fire-isolated* passageway or *fire-isolated* ramp.
- (b) A window in an *external wall* of a *fire-isolated* stairway, *fire-isolated* passageway or *fire-isolated* ramp must be protected in accordance with NC3.4 if it is within 6 m of, and exposed to -
 - (i) a *fire-source feature*; or
 - (ii) another *window* or other opening in a wall of the same building, unless they both serve the same *fire-isolated* enclosure.

NC3.9 Service penetrations in fire-isolated exits

Fire-isolated exits must not be penetrated by any service other than-

- (a) electrical wiring associated with a lighting or pressurizing system serving the *exit*;
- (b) ducting associated with the pressurizing system if it -
 - (i) is constructed of material having a FRL of not less than 60/60/60 where it passes through any other part of the building; and
 - (ii) does not open into any other part of the building; or
- (c) water supply pipes for fire services or domestic use.

NC3.10 Openings in fire-isolated lift shafts

- (a) Doorways - If a lift *shaft* is *required* to be *fire-isolated* under Part NC2, an entrance doorway to that *shaft* must be protected by - /60/30 fire doors that -
 - (i) comply with AS 1735.11; and
 - (ii) are set to remain closed except when discharging or receiving passengers, goods or vehicles.

NC3 PROTECTION OF OPENINGS

- (b) **Lift indicator panels** - A lift call panel, indicator panel or other panel in the wall of a fire-isolated lift shaft must be backed by construction having a FRL of not less than 60/60/60 if it exceeds 35x10³ mm² in area.

NC3.11 Bounding construction: Class 2, 3 and 4 buildings

- (a) A doorway in a Class 2 or 3 building must be protected if it provides access from a *sole-occupancy unit* to-
- (i) a *public corridor*, public hallway, or the like;
 - (ii) a room not within a *sole-occupancy unit*;
 - (iii) the landing of an internal non-fire-isolated *stairway* that serves as a *required exit*; or
 - (iv) another *sole-occupancy unit*.
- (b) A doorway in a Class 4 part must be protected if it provides access to any other internal part of the building.
- (c) Protection for a doorway must be at least -
- (i) in a building of Type A or B construction - a *self-closing* - /30/30 fire door; and
 - (ii) in a building of Type C construction - a *self-closing* tight fitting solid core door not less than 35 mm thick in a rebated frame.
- (d) Other openings in *internal walls* which are required to have a FRL to inhibit the lateral spread of fire must not reduce the *fire-resisting* performance of the wall.

NC3.12 Openings in floors for services

In a building of Type A and B construction, services associated with the functioning of the building and passing through a floor must either be installed in *shafts* complying with Specification NC1.1 or protected in accordance with NC3.14.

NC3.13 Openings in shafts

In a building of Type A or B construction, an opening in a wall providing access to a ventilating, pipe, garbage or other service *shaft* must be protected by -

- (a) if it is in a *sanitary compartment* - a door or panel which, together with its frame, has a FRL of not less than - /30/-; or
- (b) a *self-closing* - /30/- fire door or hopper; or

- (c) an access panel having a FRL of not less than - /30/-.

NC3.14 Openings for service installations

An electrical, electronic, plumbing, mechanical ventilation or air-conditioning, or other service that penetrates a building element (other than an *external wall* or roof) that is *required* to have a FRL or a *resistance to the incipient spread of fire*, must be installed so that the *fire-resisting* performance of the building element is not impaired.

NC3.15 Installation deemed-to-satisfy

Installation satisfies NC3.14 if -

- (a) the method and materials used are identical with a prototype assembly of the service and building element which has achieved the *required* FRL or *resistance to the incipient spread of fire*;
- (b) it complies with (a) except for the *insulation* criterion relating to the service when -
- (i) the service is farther than 100 mm from any *combustible* material; and
 - (ii) it is not located in a *required exit*;
- (c) in the case of ventilating or air-conditioning ducts or equipment the installation is in accordance with AS 1668.1;
- (d) the service is a metal pipe installed in accordance with Specification NC3.15 and it penetrates a wall, floor or ceiling, but not a *ceiling required* to have a *resistance to the incipient spread of fire*;
- (e) the service is sanitary plumbing installed in accordance with Specification NC3.15 and it -
- (i) is of metal or UPVC pipe; and
 - (ii) penetrates the floors of a Class 5, 6, 7, 8 or 9b building; and
 - (iii) is in *sanitary compartments* which are separated from other parts of the building by walls with the FRL *required* by Specification NC1.1 for a stair *shaft* in the building and a *self-closing* - /60/30 fire door;
- (f) the service is a wire or cable, or a cluster of wires or cables installed in accordance with Specification NC3.15 and it penetrates a wall, floor or ceiling, but not a *ceiling required* to have a *resistance to the incipient spread of fire*; or
- (g) the service is an electrical switch, outlet, or the like, and it is installed in accordance with Specification NC3.15.

FIRE-RESISTING CONSTRUCTION

1. SCOPE

This Specification contains requirements for the *fire-resisting construction* of building elements.

2. GENERAL REQUIREMENTS

2.1 Exposure to fire-source features

- (a) A part of a building element is exposed to a *fire-source feature* if there is no obstruction to any horizontal line between that part and the *fire-source feature* or a vertical projection of the feature. Where another part of the building obstructs any such horizontal line, the part under consideration will still be considered exposed if the obstruction has -
- (i) a FRL of not less than 30/-/-; or
 - (ii) is transparent or translucent.
- (b) A part of a building element is not exposed to a *fire-source feature* if the *fire-source feature* is -
- (i) an *external wall* of another building that stands on the allotment and the part concerned is more than 15 m above the highest part of that *external wall*; or
 - (ii) a side or rear boundary of the allotment and the part concerned is below the level of the finished ground at every relevant part of the boundary concerned.
- (c) If various distances apply for different parts of a building element-
- (i) the entire element must have the FRL applicable to that part having the least distance between itself and the relevant *fire-source feature*; or
 - (ii) each part of the element must have the FRL applicable according to its individual distance from the relevant *fire-source feature*,

but this provision does not override or permit any exemption from Clause 2.2.

2.2 Fire protection for a support of another part

A part of a building that gives direct vertical or lateral support to another part *required* to have a FRL, must have a FRL in respect of *structural adequacy* not less than the greater of -

- (a) that *required* for the part it supports; or
- (b) that *required* for the part itself,

and be *non-combustible* if the part it supports is *required* to be *non-combustible*.

2.3 Lintels

A lintel must have the FRL *required* for the part of building in which it is situated. It need not have the FRL if it does not contribute to the support of a fire door, fire window or fire shutter, and -

- (a) it spans an opening in -
 - (i) a wall of a building containing only one storey;
 - (ii) a *non-loadbearing* wall of a Class 2 or 3 building; or
- (b) it spans an opening in masonry which is not more than 150 mm thick and -
 - (i) not more than 3 m wide if the masonry is *non-loadbearing*; or
 - (ii) not more than 1.8 m wide if the masonry is *loadbearing* and part of one of the leaves of a cavity wall.

2.4 Attachments not to impair fire-resistance

- (a) A *combustible* material may be used as a finish or lining to a wall or roof, or in a sign, sunscreen or blind, awning, or other attachment to a building element which has the *required* FRL if-
- (i) the material is exempt under clause 7 of Specification NC1.6 or complies with the Early Fire Hazard indices prescribed in clause 2 of the same Specification,
 - (ii) it is not located near or directly above a *required exit* so as to make the *exit* unusable in a fire; and
 - (iii) it does not otherwise constitute an undue risk of fire spread via the facade of the building.
- (b) The attachment of a facing or finish, or the installation of ducting or any other service, to a part of a building *required* to have a FRL must not impair the *required* FRL of that part.

2.5 General concessions

- (a) Steel columns - Except in a fire wall or common wall, a steel column need not have a FRL in a building that contains only one storey.
- (b) Timber Columns - In a building that contains only one storey a timber column may be used provided:
 - (i) in a fire wall or common wall the column has the required FRL.
 - (ii) in all other cases, the column has a FRL of not less than 30/-.
- (c) Structures on roofs - A non-combustible structure situated on a roof need not comply with the other provisions of this Specification if it only contains one or more of the following:
 - (i) Hot water or other water tanks.
 - (ii) Ventilating ductwork, ventilating fans and their motors.
 - (iii) Air-conditioning chillers.
 - (iv) Window cleaning equipment.
 - (v) Lift equipment.
 - (vi) Other service units that are non-combustible and do not contain combustible fluids.

- (ii) ventilating, pipe, garbage, or similar shaft that is not for the discharge of hot products of combustion.

must be of non-combustible construction and if of lightweight construction comply with Specification NC1.5;

- (e) any flooring and floor framing in a lift pit must be non-combustible; and
- (f) the FRLs specified in Table 3 for an external column apply also to those parts of an internal column that face and are within 1.5 m of a window and are exposed through that window to a fire-source feature.

3.2 Concessions for floors

The following floors need not comply with clause 3.1:

- (a) A floor laid directly on the ground.
- (b) In a Class 2, 3, 5 or 9 building if the space below is not a storey, does not accommodate motor vehicles, is not a storage or work area, and is not used for any other ancillary purpose.
- (c) It is a timber stage floor in a Class 9b building laid over a floor having the required FRL if the space below the stage is not used as a dressing room, store room, or the like.
- (d) It separates 2 storeys within the same sole-occupancy unit in a Class 2 building.

3. TYPE A FIRE-RESISTING CONSTRUCTION

3.1 Fire-resistance of building elements

In a building required to be of Type A construction-

- (a) each part mentioned in Table 3, and any beam or column in it, must have a FRL not less than that listed in the Table, for the particular Class of building concerned;
- (b) external walls, common walls and floors must be non-combustible;
- (c) any internal wall required to have a FRL must extend to -
 - (i) the underside of the floor next above;
 - (ii) the underside of a roof complying with Table 3; or
 - (iii) a ceiling which is immediately below the roof and has a resistance to the incipient spread of fire to the roof space of 60 minutes;
- (d) (i) an internal wall required to be fire-resisting; and

3.3 Floor loading of Class 5 and 9b buildings: Concession

If a floor in a Class 5 or 9b building is designed for a live load not exceeding 3 kPa -

- (a) the floor next above (including floor beams) may have a FRL of 90/90/90; or
- (b) the roof, if that is next above (including roof beams) may have a FRL 90/60/30.

3.4 Roof superimposed on concrete slab: Concession

A roof not complying with clause 3.1 as to fire-resisting construction may be superimposed on a concrete slab roof if -

- (a) the superimposed roof and any construction between it and the concrete slab roof are non-combustible throughout; and
- (b) the concrete slab roof complies with Table 3.

**TABLE 3
TYPE A CONSTRUCTION: FRL OF BUILDING ELEMENTS**

BUILDING ELEMENT	FRL: (In minutes) <i>Structural Adequacy / Integrity / Insulation</i>	
	CLASS OF BUILDING 2, 3 or 4 part	5, 6, 7, 8 or 9
EXTERNAL WALL or other external building element excluding a roof, where the distance from any <i>fire-source feature</i> to which it is exposed is -		
For <i>loadbearing</i> parts-		
less than 1.5 m	90/90/90	120/120/120
1.5 to less than 3 m	90/60/60	120/90/90
3 or more	90/60/30	120/60/30
For <i>non-loadbearing</i> parts-		
less than 1.5 m	90/90/0	120/120/120
1.5 to less than 3 m	90/60/60	120/90/90
3 m or more	- / - / -	- / - / -
EXTERNAL COLUMN not incorporated in an <i>external wall</i> , where the distance from any <i>fire-source feature</i> to which it is exposed is -		
less than 3 m	90/ - / -	120/ - / -
3 m or more	- / - / -	- / - / -
COMMON WALLS AND FIRE WALLS -		
	90/90/90	120/120/120
INTERNAL WALLS -		
Fire-resisting lift or stair <i>shafts</i> -		
<i>Loadbearing</i>	90/90/90	90/90/90
<i>Non-loadbearing</i>	90/90/90	90/90/90
Bounding <i>public corridors</i> , public hallways and the like -		
<i>Loadbearing</i>	90/90/90	90/ - / -
<i>Non-loadbearing</i>	60/60/60	- / - / -
Between or bounding <i>sole-occupancy units</i> -		
<i>Loadbearing</i>	90/90/90	90/ - / -
<i>Non-loadbearing</i>	60/60/60	- / - / -
Ventilating, pipe, garbage, and like <i>shafts</i> not used for the discharge of hot products of combustion -		
<i>Loadbearing</i>	90/90/90	90/90/90
<i>Non-loadbearing</i>	90/90/90	90/90/90
OTHER LOADBEARING INTERNAL WALLS; and INTERNAL BEAMS, TRUSSES and COLUMNS -		
	90/ - / -	90/ - / -
FLOORS	90/90/90	120/120/120
ROOFS	90/60/30	120/60/30
MAIN ROOF BEAMS	90/ - / -	120/ - / -

3.5 Roofs: Concession

A roof need not comply with Table 3 if -

- (a) in other than a Class 2 or 3 building -
 - (i) it has an *effective height* of not more than 25 m and the roof covering and its supporting members are of *non-combustible* construction; or
 - (ii) the ceiling immediately below the roof has a *resistance to the incipient spread of fire* to the roof space of not less than 60 minutes; or
 - (iii) the building has a *non-combustible* roof covering and the storey immediately below the roof has an *automatic sprinkler system* installed throughout; or
- (c) in a Class 2 or 3 building -
 - (i) all *internal walls* bounding the *sole-occupancy units* on the topmost storey extend to the underside of a *non-combustible* roof covering; or
 - (ii) the *sole-occupancy unit* is the only unit in that storey.

3.6 Rooflights

If a roof is *required* to have a FRL or be *non-combustible*, a rooflight installed in that roof must -

- (a) have an area not more than 20% of roof surface;
- (b) be not less than 3 m from -
 - (i) any boundary of the allotment other than the boundary with a road or public place;
 - (ii) any part of the building which projects above the roof unless that part has the FRL *required* of a *fire wall* and any openings in the wall are protected in accordance with NC3.4;
 - (iii) any rooflight in an adjoining *sole-occupancy unit* if the walls bounding the unit are *required* to have a FRL; and
 - (iv) any rooflight in an adjoining fire-separated section of the building; and
- (c) be installed in a way that will maintain the level of protection to the roof space provided by a *required* ceiling with a *resistance to the incipient spread of fire*.

3.7 Internal columns and walls: Concession

If under Clause 3.5 a roof that does not have a FRL is used in a building with an *effective height* of not more than 25 m,

internal columns which are not those referred to in clause 3.1(f) and *loadbearing internal walls* which are not *fire walls*, in the storey immediately below that roof may have a FRL of 60/60/60.

3.8 Open spectator stands and indoor sports stadiums: Concession

In an *open spectator stand* or indoor sports stadium, the following building elements need not have the FRL specified in Table 3:

- (a) The roof if it is *non-combustible*.
- (b) Columns and *loadbearing* walls supporting only the roof if they are *non-combustible*.
- (c) any *non-loadbearing* part of an *external wall* less than 3 m -
 - (i) from any *fire-source feature* to which it is exposed if it has a FRL of not less than 60/ 60/ 60 and is *non-combustible*; or
 - (ii) from an *external wall* of another *open spectator stand* if it is *non-combustible*.

3.9 Carparks: Concessions

The FRLs in Table 3.9 apply to a carpark instead of those at Table 3.

BUILDING ELEMENT	FRL
Column or beam - less than 4.5 m from a <i>fire-source feature</i> to which it is exposed	60/ - / -
Wall - less than 3 m from a <i>fire-source feature</i> to which it is exposed	60/ 60/ 60
Other steel column - ratio of exposed surface area to mass per unit length not greater than 26 m ² /tonne	- / - / -
Any other column (other than a column supporting only the roof)	60/ - / -
Fire wall or lift or stair shaft	90/90/90
Any other steel floor beam - which is in continuous contact with a concrete floor slab and has a ratio of exposed surface area to mass per unit length not more than 30 m ² /tonne	- / - / -
Any other floor beam	60/ - / -
Floor slab or vehicle ramp	60/ 60/ 60.
Roof and columns supporting only the roof	- / - / -

3.10 Mezzanine floors: Concession

Except in a Class 9b building which is a spectator viewing area that accommodates more than 100 persons under ND1.13, *mezzanine floors* and any supporting building elements need not have a FRL or be *non-combustible* if every wall or column that supports any part of the building other than the *mezzanine floor* or floors within 6 m of a *mezzanine floor* has its FRL increased from that otherwise required, as set out in Table 3.10.

**TABLE 3.10
INCREASED FRLs - CONSTRUCTION SURROUNDING
MEZZANINES**

LEVEL OTHERWISE REQUIRED FOR ANY FRL CRITERION (mins)	INCREASE IN LEVEL TO (not less than):					
30	60
60	90
90	120

The increase in level applies to each FRL criterion (*structural adequacy, integrity or insulation*) relevant to the building element concerned.

3.11 Sprinklers: Concession

Each of the three criteria of the FRL otherwise required under Tables 3 and 3.9 may be reduced by 30 minutes if the building is fully protected with a *sprinkler system*.

4. TYPE B FIRE-RESISTING CONSTRUCTION

4.1 Fire-resistance of building elements

In a building required to be of Type B construction -

- (a) each part mentioned in Table 4, and any beam or column in it, must have a FRL not less than that listed in the Table for the particular Class of building concerned;
- (b) a *common wall*, the flooring and floor framing in any lift pit, and an *external wall* where a FRL is listed in Table 4, must be *non-combustible*;

(c) if a stair *shaft* supports any floor or a structural part of it -

- (i) the floor or part must have a FRL of 60 or more; or
- (ii) the junction of the stair *shaft* must be constructed so that the floor or part will be free to sag or fall in a fire without causing structural damage to the *shaft*;

(d) any *internal wall* which is required to have a FRL must extend to -

- (i) the underside of the floor next above;
- (ii) the underside of a ceiling having a *resistor* to the *incipient spread of fire* to the space above itself of not less than 60 minutes; or
- (iii) the underside of the roof covering if it is *non-combustible*, or 450 mm above the roof covering if it is *combustible*, and must be crossed by timber purlins or *non-combustible* material,

unless the wall bounds a *sole-occupancy unit* in the topmost (or only) *storey* and there is only one unit in that *storey*;

(e) an *internal wall* required to be *fire-resisting* must be of *non-combustible* construction, and if it is of *lightweight construction*, it must comply with Specification NC1.5;

(f) lift, ventilation, pipe, garbage, and similar *shaft* which are not for the discharge of hot products of combustion and not *loadbearing*, must be of *non-combustible* construction in Class 2 to 9 buildings; and

(g) all *external walls* and *fire walls* within 1.5 m of the boundary, excluding a boundary adjoining a public road or stream or other open water channel, must be extended to not less than 450 mm above the adjoining roof line to form a parapet.

**TABLE 4
TYPE B CONSTRUCTION: FRL OF BUILDING ELEMENTS**

BUILDING ELEMENT	FRL: (in minutes) <i>Structural Adequacy / Integrity / Insulation</i>	
	CLASS OF BUILDING	
	2, 3 & 4 part	5, 6, 7, 8 or 9
EXTERNAL WALL or other external building element excluding a roof, where the distance from any <i>fire-source feature</i> to which it is exposed is -		
<i>For loadbearing parts-</i>		
less than 1.5 m	60/60/60	90/90/90
1.5 to less than 3 m	60/60/30	90/90/60
3 to less than 9 m	60/30/-	90/30/30
9.0 to less than 18 m	60/-/-	90/30/-
<i>For non-loadbearing parts-</i>		
less than 1.5 m	60/60/60	90/90/90
1.5 to less than 3 m	60/60/30	90/90/60
3 m or more	-/-/-	-/-/-
EXTERNAL COLUMN not incorporated in an <i>external wall</i> , where the distance from any <i>fire-source feature</i> to which it is exposed is -		
less than 3 m	60/-/-	90/-/-
3 m or more	-/-/-	-/-/-
COMMON WALLS AND FIRE WALLS - 60/60/60 90/90/90		
INTERNAL WALLS -		
<i>Fire-resisting lift or stair shafts -</i>		
<i>Loadbearing</i>	60/60/60	60/60/60
<i>Non-loadbearing</i>	60/60/60	60/60/60
<i>Bounding public corridors, public hallways and the like -</i>		
<i>Loadbearing</i>	60/60/60	60/-/-
<i>Non-loadbearing</i>	60/60/60	-/-/-
<i>Between or bounding sole-occupancy units -</i>		
<i>Loadbearing</i>	60/60/60	60/-/-
<i>Non-loadbearing</i>	60/60/60	-/-/-
OTHER LOADBEARING INTERNAL WALLS and COLUMNS -		
	60/-/-	60/-/-
FLOORS*	60/30/30	60/60/60
MAIN ROOF BEAMS	60/-/-	60/-/-

* See NC2.5(d) for Class 9a buildings

4.2 Carparks: Concessions

The FRLs in Table 4.2 apply to a carpark instead of those at Table 4.

BUILDING ELEMENT	FRL
Column or beam - less than 4.5 m from a fire-source feature to which it is exposed ..	60/-/-
Wall - less than 3 m from a fire-source feature to which it is exposed ..	60/60/60
Other steel column - ratio of exposed surface area to mass per unit length not greater than 26 m ² /tonne ..	-/-/-
Any other column ..	60/-/-
Fire wall or lift or stair shaft ..	60/60/60
Any other steel floor beam - which is in continuous contact with a concrete floor slab and has a ratio of exposed surface area to mass per unit length not more than 30 m ² /tonne ..	-/-/-
Any other floor beam ..	60/-/-

4.3 Sprinklers: Concession

Each of the three criteria of the FRL otherwise required under Tables 4 and 4.2 may be reduced by 30 minutes if the building is fully protected with a *sprinkler system*.

5. TYPE C FIRE-RESISTING CONSTRUCTION

5.1 Fire-resistance of building elements

In a building required to be of Type C construction -

- (a) A building element listed in Table 5, and any beam or column incorporated in it, must have a FRL not less than that listed in the Table for the particular Class of building concerned.
- (b) An external wall that is required by Table 5 to have a FRL may be considered to have a FRL if the outer part of the wall has the required FRL.
- (c) A fire wall or an internal wall bounding a sole occupancy unit or separating adjoining units, if it is of *lightweight construction*, must comply with Specification NC1.5.
- (d) In a Class 2 or 3 building an internal wall which is required by Table 5 to have a FRL must extend -
 - (i) to the underside of the floor next above if that floor has a FRL of at least 30/30/30 or to a *fire protective covering* on the underside of the floor;
 - (ii) to the underside of a ceiling having a *resistance to the incipient spread of fire* to the space above itself of not less than 60 minutes; or
 - (iii) to the underside of the roof covering if it is *non-combustible*, or 450 mm above the adjoining roof covering if it is *combustible*, and must not be crossed by timber purlins or other *combustible* material,

unless the wall bounds a *sole-occupancy unit* in the topmost (or only) storey and there is only one unit in that storey.
- (e) All external walls and fire walls within 1.5 m of the boundary, excluding a boundary adjoining a public road or stream or other open water channel, must be extended to not less than 450 mm above the adjoining roof line to form a parapet.

NC1.1 FIRE-RESISTING CONSTRUCTION

**TABLE 5
TYPE C CONSTRUCTION: FRL OF BUILDING ELEMENTS**

BUILDING ELEMENT	FRL: (in minutes) <i>Structural Adequacy/Integrity/Insulation</i>		
	2	3 or 4 part	5, 6, 7, 8 or 9
EXTERNAL WALL or other external building element excluding a roof, where the distance from any <i>fire-source feature</i> to which it is exposed is -			
less than 1.5 m	60/60/60	60/60/60	60/60/60
EXTERNAL COLUMN not incorporated in an <i>external wall</i> , where the distance from any <i>fire-source feature</i> to which it is exposed is -			
less than 1.5 m	60/-/-	60/-/-	60/-/-
COMMON WALLS AND FIRE WALLS			
	60/60/60	60/60/60	60/60/60
INTERNAL WALLS -			
Bounding <i>public corridors, public hallways and the like</i>	30/30/30	60/60/60	-/-/-
Between or bounding <i>sole-occupancy units</i>	30/30/30	60/60/60	-/-/-
Bounding a stair if <i>required to be rated</i>	30/30/30	60/60/60	-/-/-

Note: See NC2.5(d) for floors of class 9a buildings.

5.2 Carparks: Concessions

The FRLs in Table 5.2 apply to a carpark instead of those at Table 5.

**TABLE 5.2
FRLs FOR CARPARKS**

BUILDING ELEMENT	FRL
Column or beam - less than 1.5 m from a <i>fire-source feature</i> to which it is exposed	60/-/-
Wall - less than 1.5 m from a <i>fire-source feature</i> to which it is exposed	60/60/60
Other steel column - ratio of exposed surface area to mass per unit length not greater than 26 m ² /tonne	-/-/-
Any other column	60/-/-
Any other steel floor beam - which is in continuous contact with a concrete floor slab and has a ratio of exposed surface area to mass per unit length not more than 30 m ² /tonne	-/-/-
Any other floor beam	60/-/-

STRUCTURAL TESTS FOR LIGHTWEIGHT CONSTRUCTION

1. Scope

This Specification contains the tests to be applied and criteria to be satisfied by *lightweight construction*.

2. Definition

Lightweight construction is -

- (a) *fire-resisting construction* which -
- (i) is not in continuous contact with the principal construction that it protects from fire; or
 - (ii) is of sheet or board material, plaster, render, sprayed application, or other material similarly susceptible to damage by pressure or abrasion;
- (b) *fire-resisting construction* which incorporates or comprises -
- (i) concrete containing pumice, perlite, vermiculite, or other soft material; or
 - (ii) masonry having a thickness less than 70 mm.

3. Application

The tests prescribed in this specification apply to construction other than concrete or masonry which need not be tested in accordance with this specification if it is designed -

- (a) in accordance with this Code; and
- (b) to resist, as serviceability loads, the appropriate pressure and impact defined in this Specification.

4. Test methods

Tests must be carried out in accordance with the following:

- (a) **Materials tests** - in accordance with the methods specified for the constituent materials of construction in the Standards adopted by reference in this Code.
- (b) **For resistance to static pressure** - The provisions for testing walls under transverse load in ASTM E72-80, except that the chamber method must not be used.
- (c) **For resistance to impact** - The provisions for testing wall systems in ASTM E695-79 (1985), except that -
 - (i) the points of impact must be set at 1.5 m above finished floor level or 1.5 m above the part of the specimen that corresponds to finished floor level; and

- (ii) the diameter of the impact bag must be between 225 mm and 260 mm and the bag must weigh 27.2 ± 0.1 kg;

- (iii) the mass must be achieved by putting loose, dry sand into the bag and must be adjusted before each series of impact tests; and

- (iv) the method may be used also for walls that depart from the vertical or that are curved and in cases where the pendulum bag and suspension cannot be vertical at the instant of impact on a concave surface or a surface inclined towards the impact, the height of drop is the net height at the point of impact.

(d) **For resistance to surface indentation** - for all materials irrespective of composition: AS 2185.

(e) **For resistance of lift shaft construction to repetitive load** - as for 3(b) except that -

- (i) the load must be applied dynamically at a frequency not less than 1 Hz and not more than 3 Hz; and

- (ii) it is sufficient to test one specimen with the pressure applied from the side of the construction on which the lift will operate.

5. Test specimens

Tests must be carried out on construction in situ or on specimens of the construction in accordance with clause 4 except that -

- (a) test specimens of the construction must be supported at top and bottom (or at each end if tested horizontally) by components identical with, and in a manner identical with, the actual construction; and
- (b) the heights of the test specimens (or lengths, if the specimens are tested horizontally) must be identical with the height between those supports in the actual construction.

6. Criteria of compliance

The following criteria must be adopted to determine compliance with this specification:

- (a) **Material** - Must comply with the applicable Standard adopted by reference in this Code.
- (b) **Damage** - The construction must show no crack, penetration or permanent surface-deformation to a depth of more than 0.5 mm nor must there be any other non-elastic deformation nor fastener failure.

NC1.5 STRUCTURAL TESTS FOR LIGHTWEIGHT CONSTRUCTION

(c) **Deflection - Static pressure** - Under static pressure the deflection of the construction must not be more than -

- (i) 1/240th of the height between supports (the span of the construction as tested);
- (ii) 30 mm; or
- (iii) 20 mm for lift shafts unless the requirements of Clause 15.2(a) of AS 1735.2 are fulfilled.

(d) **Deflection - Impact** - Under impact the instantaneous deflection of the construction must not be more than -

- (i) 1/120th of the height between supports (the span of the construction as tested);
- (ii) 30 mm; or
- (iii) 20 mm for lift shafts unless the requirements of Clause 15.2(a) of AS 1735.2 are fulfilled.

(e) **Surface indentation (AS 2185)** - No impression must be more than 5 mm in diameter.

7. Wall systems

Wall systems that are required to be fire resisting bounding public corridors, public hallways and the like, and between or bounding sole-occupancy units must be subjected to the following tests and must fulfil the following criteria:

- (a) The materials tests of clause 4(a) and the materials properties criteria of clause 6(a).
- (b) A static test by the imposition of a uniformly distributed load (or its equivalent) of 0.25 kPa in accordance with clause 4(b) and the damage and deflection criteria of clauses 6(b) and (c) respectively.
- (c) A dynamic test by the imposition of the impact of the impact bag falling through a height of 100 mm in accordance with clause 4(c) and the damage and deflection criteria of clause 6(b) and (d) respectively.
- (d) The surface indentation test of clause 4(d) and the surface indentation criterion of clause 6(e).

8. Construction bounding means of egress

Construction bounding means of egress including wall systems for use in lift shafts, stair shafts, fire-isolated passageways and fire-isolated ramps that are required to be fire-resisting must be subjected to the following tests and must fulfil the following criteria:

- (a) The materials tests of clause 4(a) and the materials properties criteria of clause 6(a).

(b) A static test by the imposition of a uniformly distributed load (or its equivalent) of 0.35 kPa in accordance with clause 4(b) and the damage and deflection criteria of clauses 6(b) and (c) respectively.

(c) A dynamic test with the impact bag falling through a height of 150 mm in accordance with clause 3(c) and the damage and deflection criteria of clause 6(b) and (d) respectively.

(d) The surface indentation test of clause 4(d) and the surface indentation criterion of clause 6(e).

9. Requirements for certain Class 9b buildings

Wall systems for use in spectator stands, sports stadia, cinemas or theatres, railway or bus stations, or airport terminals in -

- (a) lift shafts or stair shafts;
- (b) external and internal walls bounding public corridors, public hallways and the like, including fire-isolated and non-fire-isolated passageways or ramps,

must be subjected to the following tests and must fulfil the following criteria:

- (i) The materials tests of clause 4(a) and the materials properties criteria of clause 6(a).
- (ii) A static test by the imposition of a uniformly distributed load (or its equivalent) of 1.0 kPa in accordance with Clause 4(b) and the damage and deflection criteria of clauses 6(b) and (c) respectively.
- (iii) A dynamic test with the impact bag falling through a height of 350 mm in accordance with Clause 4(c) and the damage and deflection criteria of clauses 6(b) and (d) respectively.
- (iv) The surface indentation test of clause 4(d) and the criterion of clause 6(e).

10. Lift shafts

In addition to the requirements of clauses 8 and 9, wall systems for use in lift shafts that are required to be fire-resisting must be subjected to dynamic test by the imposition of 10³ cycles of a uniformly distributed load (or its equivalent) between 0 and 0.35 kPa in accordance with clause 4(e) and must fulfil the damage criteria of clause 6(b).

EARLY FIRE HAZARD INDICES

1. Scope

This Specification sets out requirements in relation to the Early Fire Hazard Indices of materials, linings and surface finishes inside buildings.

2. Class 2 to 9 buildings: General requirements

Except where superseded by clause 3 or 4, any material or component used in a Class 2, 3, 5, 6, 7, 8, or 9 building must

- (a) in the case of a *sarking-type material*, have a *Flammability Index* not more than 5;
- (b) in the case of other materials, have -
 - (i) a *Spread-of-Flame Index* not more than 9; and
 - (ii) a *Smoke-Developed Index* not more than 8 if the *Spread-of-Flame Index* is more than 5;
- (c) be completely covered on all faces by concrete or masonry not less than 50 mm thick; or
- (d) in the case of a composite member or assembly, be constructed so that when assembled as proposed in a building -
 - (i) any material which does not comply with (a) or (b) is protected on all sides and edges from exposure to the air;
 - (ii) the member or assembly, when tested in accordance with Specification A2.4, has a *Smoke-Developed Index* and a *Spread-of-Flame Index* not exceeding those prescribed in (b); and
 - (iii) the member or assembly retains the protection in position so that it prevents ignition of the material and continues to screen it from access to free air for a period of not less than 10 minutes.

3. Fire-isolated exits

In a *fire-isolated stairway*, *fire-isolated passageway*, or *fire-isolated ramp* in a Class 2 to 9 building -

- (a) a material, other than a *sarking-type material*, used in a ceiling, as an attachment to a *structural member* or as the finish, surface or lining of a *structural member* must -
 - (i) have a *Spread-of-Flame Index* of 0;
 - (ii) have a *Smoke-Developed Index* of not more than 2; and

- (iii) if *combustible*, be attached directly to a *non-combustible* substrate and not exceed 1 mm in finished thickness;

- (b) a *sarking-type material* used in the form of an exposed wall or ceiling, or as a finish or attachment thereto, must have a *Flammability Index* of 0.

4. Class 2, 3 and 9 buildings: Public areas

A material, other than a *sarking-type material* must have a *Spread-of-Flame Index* of 0 and a *Smoke-Developed Index* not more than 5 if it is used -

- (a) in a Class 2, 3, 9a or 9b building - as a finish, surface, lining or attachment to any wall or ceiling in an internal *public corridor*, hallway, or the like, which is a means of egress to -
 - (i) a stairway *required* to be fire-isolated or an external stairway used instead; or
 - (ii) a passageway, or ramp, *required* to be fire-isolated; or
- (b) in a Class 9b building which is used as a theatre, public hall, or the like -
 - (i) as a finish, surface, lining, or attachment to any ceiling, wall or floor;
 - (ii) as the covering of fixed seating in the audience seating area; or
 - (iii) in a cinema projection room.

5. Acceptable materials

A material complies with clauses 2, 3 or 4 if it is -

- (a) plaster, cement render, concrete, terrazzo, ceramic tile or the like; or
- (b) a *fire-protective covering*.

6. Fire-retardant coatings

When paint or fire-retardant coatings are used in order to make a substrate comply with a *required Spread-of-Flame Index*, *Smoke-Developed Index* or *Flammability Index*, this fact must be clearly marked on an easily visible label or labels and permanently fixed to the building element so that the coating will not be scraped off or otherwise made ineffective, without re-coating to preserve the fire-retardant properties. If any coating used will retain the *required* fire-retardant properties for only a limited period, it must be replaced before the expiry of such period so that the *required* properties are not diminished.

NC1.6 EARLY FIRE HAZARD INDICES

7. Exempted building parts and materials

The requirements in this Specification for a *Spread-of-Flame Index*, *Smoke-Developed Index* or *Flammability Index* do not apply to -

- (a) timber-framed windows;
- (b) solid timber handrails or skirtings;
- (c) timber-faced solid-core or fire doors;
- (d) electrical switches, outlets, cover plates or the like;
- (e) materials used for -
 - (i) roof covering or membranes, or roof insulating material, applied in continuous contact with a substrate;
 - (ii) adhesives; or
 - (iii) damp-proof courses, flashings, caulking, sealing, ground moisture barriers, or the like;
- (f) paint, varnish, lacquer or similar finish, other than nitro-cellulose lacquer;
- (g) a clear or translucent rooflight of glass fibre reinforced polyester if -
 - (i) the roof in which it is installed forms part of a building in Type C construction;
 - (ii) the material is used as part of the roof covering;
 - (iii) it is not prohibited by any other clause of this Code;
 - (iv) it is not closer than 1.5 m from another rooflight of the same type;
 - (v) each rooflight is not more than 14 m² in area; and
 - (vi) the area of the rooflights is not more than 20% of roof surface; or
- (h) any other material which does not significantly increase the hazards of fire.

FIRE DOORS, SMOKE DOORS, FIRE WINDOWS AND SHUTTERS

1. Scope

This Specification sets out requirements for the construction of fire doors, smoke doors, fire windows and fire shutters.

2. Fire doors

A required fire door must comply with NZS 4232, except that -

- (a) it may be fully glazed or incorporate glazing if the tested prototype was similarly glazed;
- (b) the radiation level at a distance of 365 mm from the face of the glazing must not exceed 10 kW/m² during the period corresponding to that for insulation in the required FRL;
- (c) the rise in average temperature on the side of the tested prototype remote from the furnace must not exceed 140°C (except in any glazed part) during the first 30 minutes of the fire test.

3. Smoke doors

A required smoke door -

- (a) may have one or 2 door leaves;
- (b) must swing -
 - (i) in the direction of egress; or
 - (ii) in both directions if the path of travel to exits is in either direction;
- (c) must be self-closing and may be fitted with an automatic release device; and
- (d) must be constructed of -

(i) solid-core timber at least 35 mm thick, glazed panels in a timber frame at least 35 mm thick, or a metal frame, with a mid-rail or suitable crash bar; or

(ii) PVC, or other suitable material;

and if necessary, be fitted with smoke seals.

4. Fire shutters

A required fire shutter must -

- (a) be a shutter that -
 - (i) is identical with a tested prototype that has achieved the required FRL;
 - (ii) is installed in the same manner and in an opening that is not larger than the tested prototype; and
 - (iii) did not have a rise in average temperature on the side remote from the furnace of more than 140°C during the first 30 minutes of the test; or
- (b) is a steel shutter complying with NZS 4232 if a metallic fire shutter is not prohibited by NC3.5.

5. Fire windows

A required fire window must be -

- (a) identical in construction with a prototype that has achieved the required FRL; and
- (b) installed in the same manner and in an opening that is not larger than the tested prototype.

PENETRATION OF WALLS, FLOORS AND CEILINGS BY SERVICES

1. Scope

This Specification prescribes materials and methods of installation for services that penetrate walls, floors and ceilings *required* to have a FRL.

2. Application

- (a) This Specification applies to installations permitted under this Code as alternatives to systems that have been demonstrated by test to fulfil the requirements of NC3.14.
- (b) This Specification does not apply to installations in ceilings *required* to have a *resistance to the incipient spread of fire* nor to the installation of piping that contains or is intended to contain a flammable liquid or gas.

3. Metal pipes

- (a) A metal pipe that is not normally filled with liquid must not penetrate a wall, floor or ceiling within 100 mm of any *combustible* material unless wrapped or fire stopped to satisfy the requirements of Clause 7, and must be constructed of -
 - (i) copper alloy or stainless steel with a wall thickness of at least 1 mm; or
 - (ii) cast iron or steel (other than stainless steel) with a wall thickness of at least 2 mm.
- (b) An opening for a metal pipe must -
 - (i) be neatly formed, cut or drilled;
 - (ii) be no closer than 200 mm to any other service penetration; and
 - (iii) accommodate only one pipe.
- (c) A metal pipe must be wrapped but must not be lagged or enclosed in thermal insulation over the length of its penetration of a wall, floor or ceiling unless the lagging or thermal insulation fulfils the requirements of clause 7.
- (d) The gap between a metal pipe and the wall, floor or ceiling it penetrates must be fire-stopped in accordance with clause 7.

4. Pipes penetrating sanitary compartments

If a pipe of metal or UPVC penetrates the floor of a *sanitary compartment* in accordance with NC3.15(e) of this Code -

- (a) the opening must be neatly formed and no larger than is necessary to accommodate the pipe or fitting; and

- (b) the gap between pipe and floor must be fire-stopped in accordance with clause 7.

5. Wires and cables

If a wire or cable or cluster of wires or cables penetrates a floor, wall or ceiling -

- (a) the opening must be neatly formed, cut or drilled and no closer than 50 mm to any other service opening; and
- (b) the opening must be no larger in cross-sectional area than -
 - (i) 2000 mm² if only a single cable is accommodated and the gap between cable and wall, floor or ceiling is no wider than 15 mm; or
 - (ii) 500 mm² in any other case; and
- (c) the gap between the service and the wall, floor or ceiling must be fire-stopped in accordance with clause 7.

6. Electrical switches and outlets

If an electrical switch, outlet, socket or the like is accommodated in an opening or recess in a wall, floor or ceiling -

- (a) the opening or recess must not -
 - (i) be located opposite any point within 300 mm horizontally nor 600 mm vertically of any opening or recess on the opposite side of the wall; nor
 - (ii) extend beyond half the thickness of the wall; and
- (b) the gap between the service and the wall, floor or ceiling must be fire-stopped in accordance with clause 7.

7. Fire-stopping

- (a) **Material:** The material used for fire-stopping of service penetrations must be concrete, high-temperature mineral fibre, high-temperature ceramic fibre or other material that does not flow at a temperature below 1120°C when tested in accordance with AS 1038.15, and must have -
 - (i) demonstrated in a system tested in accordance with NC3.15(a) of this Code that it does not impair the *fire-resisting* performance of the building element in which it is installed; or

- (ii) demonstrated in a test in accordance with (e) that it does not impair the *fire-resisting* performance of the test slab.
- (b) **Installation:** Fire-stopping material must be packed into the gap between the service and wall, floor or ceiling in a manner, and compressed to the same degree, as adopted for testing under 7(a)(i) or (ii).
- (c) **Hollow construction:** If a pipe penetrated a hollow wall (such as a stud wall, a cavity wall or a wall of hollow blockwork) or a hollow floor/ceiling system, the cavity must be so framed and packed with fire-stopping material that the material is -
- (i) installed in accordance with 7(b) to a thickness of 25 mm all round the service for the full length of the penetration; and
- (ii) restrained, independently of the service, from moving or parting from the surfaces of the service and of the wall, floor or ceiling.
- (d) **Recesses:** If an electrical switch, socket, outlet or the like is accommodated in a recess in a hollow wall or hollow floor/ceiling system -
- (i) the cavity immediately behind the service must be framed and packed with fire-stopping material in accordance with 7(c); or
- (ii) the back and sides of the service must be protected with refractory lining board identical with and to the same thickness as that in which the service is installed.
- (e) **Test:** The test to demonstrate compliance of a fire-stopping material with this Specification must be conducted as follows:
- (i) The test specimen must comprise a concrete slab not less than 1 m square and not more than 100 mm thick, and appropriately reinforced if necessary for *structural adequacy* during manufacture, transport and testing.
- (ii) The slab must have a hole 50 mm in diameter through the centre and the hole must be packed with the fire-stopping material.
- (iii) The slab must be conditioned in accordance with AS 1530.4.
- (iv) Two thermocouples complying with AS 1530.4 must be attached to the upper surface of the packing each about 5 mm from its centre.
- (v) The slab must be tested on flat generally in accordance with Section 10 of AS 1530.4

**NATIONAL
BUILDING
CODE
1990**

PUBLIC BUILDINGS AND GROUP DWELLINGS (CLASS 2 TO 9)

SECTION ND

ACCESS AND EGRESS

**Performance Requirements
Deemed-to-Satisfy Provisions**

- ND1 Provision for Escape**
- ND2 Construction of Exits**
- ND3 Access for People with Disabilities**

CONTENTS

PERFORMANCE REQUIREMENTS

DEEMED-TO-SATISFY PROVISIONS

Part		Part	
ND1	Provision for Escape	ND2.4	Separation of rising and descending stair flights
ND1.1	Application	ND2.5	Open access ramps and balconies
ND1.2	Number of exits required	ND2.6	Smoke lobbies
ND1.3	When smoke or fire-isolated exits are required	ND2.7	Installations in exits and paths of travel
ND1.4	Exit travel distances	ND2.8	Enclosure of space under stairs and ramps
ND1.5	Distance between alternative exits	ND2.9	Width of stairways
ND1.6	Dimensions of exits	ND2.10	Ramps
ND1.7	Travel via smoke or fire-isolated exits	ND2.11	Fire-isolated passageways
ND1.8	External stairways	ND2.12	Roof as open space
ND1.9	Travel by non-fire-isolated stairways or ramps	ND2.13	Treads and risers
ND1.10	Discharge from exits	ND2.14	Landings
ND1.11	Horizontal exits	ND2.15	Thresholds
ND1.12	Non-required stairways, ramps or escalators	ND2.16	Balustrades
ND1.13	Number of persons accommodated	ND2.17	Handrails
ND1.14	Measurement of distances	ND2.18	Fixed platforms, walkways and ladders
ND1.15	Method of measurement	ND2.19	Doorways and doors
		ND2.20	Swinging doors
		ND2.21	Operation of latch
		ND2.22	Re-entry from fire-isolated exits
ND2	Construction of Exits	ND3	Access for People with Disabilities
ND2.1	Application of Part	ND3.1	Application of Part
ND2.2	Fire-isolated stairways and ramps	ND3.2	Access to building
ND2.3	Non-fire-isolated stairways and ramps	ND3.3	Parts of buildings to be accessible
		ND3.4	Concessions

PERFORMANCE REQUIREMENTS

OBJECTIVES

A building must be so designed and constructed that the following objectives are fulfilled:

NDP1 Provision for Escape

There must be adequate means of escape, in case of fire or other emergency from all parts of the building to a place of safety.

NDP2 Construction of Exits

- (a) Stairways, ramps and passageways must be such as to provide safe passage for the users of the building.
- (b) Stairways and ramps must not be uncomfortable or strenuous to use.
- (c) Stairways, ramps, floors and balconies, and any roof to which people normally have access, must have bounding walls, balustrades or other barriers where necessary to protect users from the risk of falling.
- (d) Vehicle ramps and any floor to which vehicles have access must have kerbs or other barriers where necessary to provide protection to pedestrians and to the structure of the building.

NDP3 Access for People with Disabilities

Reasonable provision must be made in the design of a building, having regard to its use and location, to facilitate access and circulation by people with disabilities.

REQUIRED PERFORMANCE

NDP1.1 The design and construction of buildings must allow all occupants in any or all fire compartments to get to-

- (a) any one of more than one exit within 2.5 minutes; or
- (b) in the case of buildings with 3 or fewer stories or a basement of less than 50 m² floor area, to a single exit within 1 minute.

NDP2.1 The design and construction of exits must allow for the following optimum conditions during evacuation in any emergency -

- (a) a density in the exit of 2.0 persons/m² of exit floor area;
- (b) a speed of movement along the slope of the exit of 0.5 m/s; and
- (c) an average flow of 1.18 persons per second per metre effective width of exit.

In the case of occupancies such as hospitals where evacuation needs the assistance of others and/or of equipment, additional consideration must be given to the design of exits.

The pitch of any stairway or slope of a ramp must not be unsafe or uncomfortable.

The size of openings in any bounding wall, balustrade or the like must be such as to prevent very young mobile children from going through them and injuring themselves. These must also be designed to discourage young children under 5 years of age from gaining any foothold and climbing over them.

NDP3.1 People with disabilities must have the facility to gain reasonable access to buildings so that they are not at any material disadvantage when compared with others.

DEEMED-TO-SATISFY PROVISIONS

PROVISION FOR ESCAPE

ND1.1 Application

This Part applies to all buildings except the internal parts of a *sole-occupancy unit* in a Class 2 or 3 building or Class 4 part.

ND1.2 Number of exits required

- (a) **All buildings** - Every building must have at least one *required exit*.
- (b) **Class 2 to 8 buildings** - In addition to any *horizontal exit*, not less than 2 *exits* must be provided from each *storey* if the building has a *rise* of 3 or more *storeys* or an *effective height* of more than 10 m.
- (c) **Basements** - In addition to any *horizontal exit*, not less than 2 *exits* must be provided from any *storey* if egress from that *storey* involves an upward vertical climb within the building of more than 1.5 m, unless-
- (i) in addition to a single *exit* other than a *horizontal exit*, one or more openable or easily breakable *windows* or other openings are available in which case the top of the sill must be no higher than 1.5 m from the floor level of the room. In addition the *windows* or openings must have one clear dimension of at least 600 mm and a minimum opening of 0.6 m². The *windows* or openings must be clear of any surrounding ground by at least 1 m horizontally and the vertical drop from the sill to the ground outside, no more than 2 m; or
- (ii) the area of the *storey* is not more than 50 m² as well as the distance of travel from any point on the floor to a single *exit*, not more than 20 m.
- (d) **Class 9 buildings** - In addition to any *horizontal exit*, and subject to (e) and (f) not less than 2 *exits* must be provided from -
- (i) each *storey* if the building has a *rise* of 3 or more *storeys* or an *effective height* of more than 10 m;
- (ii) any *storey* which includes a *ward area* in a Class 9a building;
- (iii) each *storey* in a Class 9b building used as an *early childhood centre*; and
- (iv) any *storey* or *mezzanine* that accommodates more than 100 persons, calculated under ND1.13.

(e) **Exits from divided wards:** In a Class 9a building, at least one *exit* must be provided from every portion of a *storey* which has been divided in accordance with NC2.5.

(f) **Exits in open spectator stands:** In an *open spectator stand* containing more than one tier of seating, every tier must have not less than 2 stairways or ramps, each forming part of the path of travel to not less than 2 *exits*.

ND1.3 When smoke or fire-isolated exits are required

Every *required exit* other than an external stairway or open ramp must be -

- (a) smoke isolated to the relevant requirements of ND2.6(b) and (c) if it connects 3 or more consecutive *stories*; and
- (b) fire isolated if it connects 5 or more consecutive *stories*.

Exception: These requirements do not apply to *exits* that form part of an *open spectator stand*.

ND1.4 Exit travel distances

- (a) **Class 2 and 3 buildings and class 4 parts:**
- (i) The entrance doorway of any *sole-occupancy unit* must be not more than 6 m from an *exit* or from a point at which travel in different directions to 2 *exits* is available. Further the route of travel within the unit from any point other than from a kitchen or cooking area, to the doorway must not traverse through a kitchen or cooking area; and
- (ii) no point on the floor of a room which is not in a *sole-occupancy unit* must be more than 20 m from an *exit* or from a point at which travel in different directions to 2 *exits* is available, in which case the maximum distance to one of those *exits* must not exceed 40 m from the starting point.
- (b) **Class 5 to 9 buildings:**
- Subject to (c), (d) and (e):
- (i) No point on a floor must be more than 20 m from an *exit*, or a point from which travel in different directions to 2 *exits* is available, in which case the maximum distance to one of those *exits* must not exceed 40 m from the starting point.

ND1 PROVISION FOR ESCAPE

- (ii) In a Class 5 or 6 building, the distance to a single exit serving at the level of access to a road or open space may be increased to 30 m.
- (c) **Class 9a buildings:** In a ward area in a Class 9a building -
 - (i) no point on the floor must be more than 12 m from a point from which travel in different directions to 2 of the required exits is available; and
 - (ii) the maximum distance to one of those exits must not be more than 30 m from the starting point.
- (d) **Open spectator stands:** The distance of travel to an exit in a Class 9b building used as an open spectator stand must be not more than 60 m.
- (e) **Assembly buildings:** In a Class 9b building other than a school or early childhood centre, the distance to one of the exits may be 60 m if -
 - (i) the path of travel from the room concerned to that exit is through another area which is a corridor, hallway, lobby, ramp or other circulation space;
 - (ii) the room is smoke-separated from the circulation space by construction such that -
 - any wall be non-combustible and extend to the underside of the floor above or of the roof covering;
 - only have doorways which are fitted with smoke doors complying with Specification NC3.4 and which do not extend higher than 800 mm from the underside of an imperforate roof covering, floor or ceiling above it; and
 - (iii) the maximum distance of travel does not exceed 40 m within the room and 20 m from the doorway to the room through the circulation space to the exit.

ND1.5 Distance between alternative exits

Exits that are required as alternative means of egress must be -

- (a) distributed as uniformly as practicable within or around the storey served;
- (b) not less than 9 m apart; and
- (c) not more than -
 - (i) 45 m apart in a Class 2 or 3 building or a storey containing a ward area in a Class 9a building; or

- (ii) 60 m apart in all other cases.

ND1.6 Dimensions of exits

In a required exit or path of travel to an exit -

- (a) the unobstructed height throughout must be not less than 2 m;
- (b) if the storey or mezzanine pertains to a Class 2 or 3 buildings or accommodates not more than 100 persons, the unobstructed width except for doorways must be -
 - (i) not less than 1 m; or
 - (ii) 2 m in a passageway from a ward area;
- (c) if the storey or mezzanine accommodates more than 100 persons and not more than 200 persons the aggregate width, except for doorways, must be not less than -
 - (i) 1 m plus 250 mm for each 25 persons (or part) in excess of 100; or
 - (ii) 2 m in a passageway from a ward area in class 9a buildings;
- (d) if the storey or mezzanine accommodates more than 200 persons, the aggregate width, except for doorways, must be increased to -
 - (i) 2 m plus 500 mm for every 60 persons (or part) in excess of 200 persons if egress involves a change in floor level by a stairway or ramp with a gradient more than 1:12; or
 - (ii) in any other case, 2 m plus 500 mm for every 75 persons (or part) in excess of 200;
- (e) in an open spectator stand which accommodates more than 2000 persons the width except for doorways must be increased to 17 m plus a width (in meters) equal to the number in excess of 2000 divided by 600;
- (f) the clear openings of a doorway must be not less than -
 - (i) in ward areas - 1.6 m wide or 1.25 m if it is a horizontal exit;
 - (ii) in areas used by students in a school - 870 mm wide;
 - (iii) the width of exit required by (b), (c), (d) or (e), minus 250 mm, or
 - (iv) in any other case except where it opens to a sanitary compartment or bathroom - 760 mm wide; and
- (g) the required width of exit must not diminish in the direction of travel to a road or open space.

ND1.7 Travel via smoke or fire-isolated exits

- (a) A doorway from a room must not open directly into a stairway, passageway or ramp that is *required* to be smoke or fire-isolated unless it is from -
- (i) a public lobby, *public corridor*, hallway, or the like;
 - (ii) a *sole-occupancy unit* occupying all of a storey; or
 - (iii) a *sanitary compartment*, airlock or the like.
- (b) Each stairway or ramp that is *required* to be smoke or fire isolated must provide independent egress from the storey served and discharge -
- (i) directly, or by way of a *fire-isolated passageway*, to a road or *open space*; or
 - (ii) into a *storey* or space within the confines of the building that is enclosed for not more than 1/3 of its perimeter and used only for pedestrian movement, car parking, or the like, to a point where an unimpeded path of travel not further than 20 m is available to a road or *open space*.
- (c) If more than 2 access doors, other than from a *sanitary compartment* or the like, open to a fire-isolated *exit* in the same storey -
- (i) a smoke lobby in accordance with ND2.6 must be provided; or
 - (ii) the *exit* must be pressurised in accordance with NE2.7.
- (d) A ramp must be provided at any change in level less than 600 mm in a *fire-isolated passageway* in a Class 9 building.

ND1.8 External stairways

An external stairway may serve as a *required exit* instead of a smoke isolated or *fire-isolated stairway* in a building with an *effective height* of not more than 25 m if the stairway (including any connecting bridges) is of *non-combustible* construction throughout, and -

- (a) if any part of the stairway is exposed to, and less than 6 m from, a *window*, doorway or the like in an *external wall*, the stairway must be fully shielded in the affected area from such *window* or doorway by *non-combustible* construction with a FRL of not less than 60/60/60;
- (b) if any part of the stairway is exposed to, and less than 6 m but more than 3 m from, a *window*, doorway or the like in an *external wall* of any building, the *window* doorway or the like must be protected in accordance with NC3.4.

ND1.9 Travel by non-fire-isolated stairways or ramps

- (a) A *non-fire-isolated stairway* serving as a *required exit* must provide a continuous means of travel by its own flights of stairs and landings from every storey served to the level at which egress to a road or *open space* is provided.
- (b) In a Class 2, 3 or 4 building, the distance between the doorway of a room or *sole-occupancy unit* and the point of egress to a road or *open space* by way of any *required* stairway or ramp that is not fire-isolated must not exceed -
- (i) 30 m in a building of Type C construction; or
 - (ii) 60 m in all other cases.
- (c) In a Class 5 to 9 building, the distance from any point on a floor and a point of egress to a road or *open space* by way of a *required non-fire-isolated stairway* or ramp must not exceed 80 m.
- (d) In a Class 2, 3 or 9a building, a *required non-fire-isolated stairway* or ramp must discharge at a point not more than -
- (i) 15 m from a doorway providing egress to a road or *open space* or from a *fire-isolated passageway* leading to a road or *open space*; or
 - (ii) 30 m from one of 2 such doorways or passageways if travel to each of them from the stairway or ramp is in opposite or approximately opposite directions.
- (e) In a Class 5 to 8 or 9b building, a *required non-fire-isolated stairway* or ramp must discharge at a point not more than -
- (i) 20 m from a doorway providing egress to a road or *open space* or from a *fire-isolated passageway* leading to a road or *open space*; or
 - (ii) 40 m from one of 2 such doorways or passageways if travel to each of them from the stairway or ramp is in opposite or approximately opposite directions.
- (f) If 2 or more *exits* are *required* and are provided by means of internal *non-fire-isolated stairways* or *non fire-isolated ramps*, each *exit* must -
- (i) provide separate egress to a road or *open space*; and
 - (ii) be suitably smoke-separated from each other at the level of discharge.

ND1 PROVISION FOR ESCAPE

ND1.10 Discharge from exits

- (a) An *exit* must not be blocked at the point of discharge and where necessary, suitable barriers must be provided to prevent vehicles from blocking the *exit*, or access to it.
- (b) If a *required exit* leads to an *open space*, the path of travel to the road must have an unobstructed width throughout of not less than -
- (i) the minimum width of the *required exit*; or
 - (ii) 1 m;
- whichever is the greater.
- (c) If an *exit* discharges to *open space* that is at a level different from the public road to which it is connected, the path of travel to the road must be by -
- (i) a ramp or other incline having a grade of not more than 1:8 at any part, or 1:14 if *required* by Part ND3; or
 - (ii) a stairway complying with this Code, except if the *exit* is from a Class 9a building.
- (d) The discharge point of alternative *exits* must be located as far apart as practicable.
- (e) In a Class 9b building which is an *open spectator stand* that accommodates more than 500 persons a *required stairway* or *required ramp* must not discharge to the ground in front of the stand.
- (f) In a Class 9b building containing an auditorium which accommodates more than 500 persons, not more than 2/3 of the *required* width of *exits* must be located in the main entrance foyer.

ND1.11 Horizontal exits

Horizontal exits must -

- (a) not be counted as a *required exit*, when -
- (i) between *sole-occupancy units*; or
 - (ii) in a Class 9b building used as an *early childhood centre*, primary or secondary school;
- (b) not comprise more than 50% of the number of *required exits* from any part of a *storey* which has been divided by a *fire wall*; and
- (c) have a clear area on each side of the *fire wall* to

accommodate the total number of persons (calculated under ND1.13) from both parts of the *storey*, of not less than -

- (i) 2.5 m² per patient in a Class 9a building; and
- (ii) 0.5m² per person in any other case.

ND1.12 Non-required stairways, ramps or escalators

Escalators, moving walkways or non-*required* non-*fire-isolated stairways* or pedestrian ramps -

- (a) must not be used in a *ward area* in a Class 9a building;
- (b) may connect any number of *storeys* if they are -
- (i) in an *open spectator stand* or indoor sports stadium;
 - (ii) in a *carpark* or an *atrium*; or
 - (iii) outside a building;
- (c) must not connect, directly or indirectly, more than 2 consecutive *storeys* at any level in a Class 5, 6, 7, 8 or 9 building; and
- (d) in any other case, must not connect more than 2 consecutive *storeys*, provided that one of those *storeys* is situated at a level at which there is direct egress to a road or *open space*.

ND1.13 Number of persons accommodated

The number of persons accommodated in a *storey*, room or *mezzanine floor* must be determined with consideration to the purpose for which it is used and the layout of the *floor area* by -

- (a) calculating the sum of the numbers obtained by dividing the *floor area* of each part of the *storey* by the number of square metres per person listed in Table ND1.13 according to the use of the part, excluding spaces set aside for -
- (i) lifts, stairs, ramps and escalators, corridors, hallways, lobbies, and the like;
 - (ii) service ducts and the like, *sanitary compartments* or other ancillary uses;
- (b) reference to the seating capacity in an *assembly building* or room; or
- (c) any other suitable means of assessing its capacity.

**TABLE ND1.13
AREA PER PERSON ACCORDING TO USE**

TYPE OF USE	m ² per person
Art gallery, exhibition area, museum	4
Bar, cafe, church, dining room	1
Board room	2
Boarding house	15
Computer room for main frame and mini computers	25
Court room - judicial area	10
- public seating	1
Dance floor	0.5
Dormitory	8
Early childhood centre	4
Factory - (a) machine shop, fitting shop, or like place for cutting, grading, finishing or fitting of metals or glass, except in the fabrication of structural steelwork or manufacture of vehicles or bulky products	5
(b) areas used for fabrication and processing other than those in (a)	50
(c) a space in which the layout and natural use of fixed plant or equipment determine the number of persons which will occupy the space during working hours	Area per person determined by the use of the plant or equipment.
Garage - public	30
Gymnasium	3
Hospital ward area	10
Hostel, hotel, motel, guest house	15
Indoor sports stadium - arena	10
Kiosk	1
Kitchen, laundry (other than domestic) and laboratory	10
Library - reading space	2
- storage space	30
Office, including one for typewriting or document copying or with desk-top computers	10
Plant Room for ventilation, electrical or other service units	30
boilers or power plant	50
Reading Room	2
Restaurant	1
School - common staff room	2
individual staff room	10
- general classroom	2
only as for others	
- multi-purpose hall	1
- trade and practical area : primary	4
secondary	As for Workshop
Shop - space for sale of goods - (a) at a level entered direct from the open air or any lower level	3
(b) all other levels	5

TABLE ND1.13 Continued
AREA PER PERSON ACCORDING TO USE

Showroom - display	5
Skating rink, based on rink area	1.5
Spectator stand, audience viewing area :	
- bench seating	450 mm/person
- fixed seating	number of seats
- seating not fixed	1
- standing viewing area	0.3
Storage space	30
Swimming pool, based on pool area	1.5
Switch room, transformer room	30
Telephone exchange - private	30
Theatre dressing room	4
Transport terminal	2
Workshop - for maintenance staff	30 (in the whole area)
- for manufacturing processes	As for factory

ND1.14 Measurement of distances

The nearest part of an *exit* means in the case of -

- (a) A *fire-isolated stairway, fire-isolated passageway, fire-isolated ramp*, the nearest part of the doorway providing access to them.
- (b) A *non-fire-isolated stairway*, the nearest part of the nearest riser.
- (c) A *non-fire-isolated ramp*, the nearest part of the junction of the floor of the ramp and the floor of the storey.
- (d) A doorway opening to a road or *open space*, the nearest part of that doorway.
- (e) A *horizontal exit*, the nearest part of the doorway.

(b) Subject to (d) and (f), the distance from the doorway of a room or *sole-occupancy unit* in a Class 2, 3 or 4 building is measured in a straight line to the nearest part of the *required single exit* or point from which travel in different direction to 2 *required exits* is available.

(c) Subject to (d) and (f), the distance between *exits* is measured in a straight line between the nearest parts of those *exits*.

(d) Only the shortest distance is taken along a corridor, hallway, external balcony or other path of travel that curves or changes direction.

(e) If more than one corridor, hallway, or other similarly defined internal path of travel connects *required exits*, the measurement is along the path of travel through the point at which travel in different directions to those *exits* is available.

ND1.15 Method of measurement

The following rules apply:

- (a) In the case of a room that is not a *sole-occupancy unit* in a class 2 or 3 building or class 4 part of a building, the distance includes the straight-line measurement from any point on the floor of the room to the nearest part of a doorway leading from it, together with the distance from that part of the doorway to the single *required exit* or point from which travel in different directions to 2 *required exits* is available.

(f) If a wall (including a demountable *internal wall*) that does not bound-

- (i) a room; or
- (ii) a corridor, hallway or the like,

causes a change of direction in proceeding to a *required exit*, the distance is measured along the path of travel past that wall.

(g) If permanent fixed seating is provided, the distance is measured along the path of travel between the rows of seats.

CONSTRUCTION OF EXITS

ND2.1 Application of Part

Except for ND2.13 and ND2.16, this Part does not apply to the internal parts of a *sole-occupancy unit* in a Class 2 or Class 3 building or a Class 4 part.

ND2.2 Fire-isolated stairways and ramps

A stairway or ramp (including any landings) that is *required* to be within a *fire-resisting shaft* must be constructed -

- (a) of *non-combustible* materials; and
- (b) so that if there is local failure, it will not cause structural damage to, or impair the fire-resistance of the *shaft*.

ND2.3 Non-fire-isolated stairways and ramps

In a building having a *rise* of more than 2 storeys, *required* stairs and ramps (including landings and any supporting *structural members*) which are not *required* to be within a *fire-resisting shaft*, must be constructed according to ND2.2, or only of -

- (a) reinforced or prestressed concrete;
- (b) steel in no part less than 6 mm thick; or
- (c) timber that -
 - (i) has a finished thickness of not less than 40 mm;
 - (ii) has an average density of not less than 800 kg/m³ at a moisture content of 12%; and
 - (iii) has not been joined by means of glue unless it has been laminated and glued with resorcinol formaldehyde or resorcinol phenol formaldehyde glue.

ND2.4 Separation of rising and descending stair flights

If a stairway serving as an *exit* is *required* to be fire-isolated-

- (a) there must be no direct connection between a flight of stairs rising from a *storey* below the lowest level of access to a road or *open space*; and a flight of stairs descending from a *storey* above that level; and
- (b) any construction that separates or is common to the rising and descending flights of stairs must be *non-combustible* and have a FRL of not less than 60/60/60.

ND2.5 Open access ramps and balconies

A *required* open access ramp or balcony must -

- (a) have ventilation openings to the outside air which -
 - (i) have a total unobstructed area not less than the *floor area* of the ramp or balcony; and
 - (ii) are evenly distributed along the open sides of the ramp or balcony; and
- (b) not be enclosed on its open sides above a height of 1 m except by an open grille or the like having a free air space of not less than 75% of its area.

ND2.6 Smoke lobbies

A smoke lobby *required* by ND1.7 must -

- (a) have a *floor area* not less than 6 m²;
- (b) be separated from the occupied areas in the *storey* by walls which are impervious to smoke, and -
 - (i) have a FRL of not less than 30/30/- (which may be plasterboard, face brickwork, glass blocks or glazing);
 - (ii) extend from floor to floor, or to the underside of a ceiling with a *resistance to the incipient spread of fire* of 60 minutes which covers the lobby;
 - (iii) construction joints between the top of the walls and the floor, roof or ceiling must be smoke sealed with intumescent putty or other suitable material;
- (c) at any opening from the occupied areas, have smoke doors to Specification NC3.4, which are *self-closing* or held open by a fail-safe *automatic* magnetic release device; and
- (d) be pressurised to NE2.7 as part of the *exit* if the *exit* is *required* to be pressurised.

ND2.7 Installations in exits and paths of travel

- (a) Access to service *shafts* and services other than to fire-fighting or detection equipment as permitted in Section NE, must not be provided from a *fire-isolated stairway*, passageway or ramp.
- (b) An opening to any chute or duct conveying hot products of combustion must not be located in any part of a *required exit* or any corridor, hallway, lobby or the like leading to a *required exit*.

ND2 CONSTRUCTION OF EXITS

(c) Gas or other fuel services must not be installed in a *required exit*.

(d) Services or equipment must not be installed in a *required exit* or in any corridor, hallway, lobby or the like leading to a *required exit* if it comprises -

- (i) electricity meters, distribution boards or ducts;
- (ii) central telecommunications distribution boards or equipment; or
- (iii) electrical motors or other motors serving equipment in the building;

unless it is enclosed by *non-combustible* construction or a *fire-protective covering*.

ND2.8 Enclosure of space under fire-isolated stairs and ramps

(a) **Fire-isolated stairways and ramps** - If the space below a *required fire-isolated stairway* or ramp is within the *fire-isolated shaft*, it must not be enclosed to form a cupboard or similar enclosed space.

(b) **Non-fire-isolated stairways and ramps** - The space below a *required non-fire-isolated stairway* (including an external stairway) or ramp must not be enclosed to form a cupboard or other enclosed space unless-

- (i) the enclosing walls and ceilings have a FRL of not less than 60/60/60; and
- (ii) any access doorway to the enclosed space is fitted with a self-closing -/60/30 fire door.

ND2.9 Width of stairways

(a) The *required* width of a stairway must -

- (i) be measured clear of all obstructions such as handrails, projecting parts of balustrades, columns, beams, and the like; and
- (ii) extend without interruption, except for ceiling cornices, to a height not less than 2 m vertically above a line along the nosings of the treads or the floor of the landing.

(b) A *required* stairway that exceeds 2 m in width is counted as having a width of only 2 m unless it is divided by a balustrade or handrail continuous between landings and each division is less than 2 m wide.

ND2.10 Ramps

ND2.10.1 Pedestrian ramps

(a) A *fire-isolated ramp* may be substituted for a *fire-isolated stairway* if the construction enclosing the ramp and the width and ceiling height comply with the requirements for a *fire-isolated stairway*.

(b) a ramp serving as a *required exit* must have a gradient of not more than -

- (i) 1:12 in areas used by patients in a Class 9a building; or
- (ii) 1:14 if required by Part ND3;
- (iii) 1:10 if subject to wetting; or
- (iv) 1:8 in any other case.

(c) The floor surface of a ramp must have a non-slip finish.

ND2.10.2 Service ramps

Service ramps must not be steeper than 1:3. Where they are steeper than 1:8 cleats must be provided at the spacing shown in Table ND2.10.2. Two examples are shown in figure ND2.10.2.

**TABLE ND2.10.2
SPACING OF CLEATS FOR SERVICE RAMPS**

Ramp slope not more than	CLEAT SPACING (mm)	
	Goods carried	No goods carried
1:6	360	460
1:5	330	430
1:4	300	400
1:3	280	380

ND2.11 Fire-isolated passageways

A *fire-isolated passageway* must be enclosed by walls, floors, and ceilings of *non-combustible* construction with a FRL of-

- (a) not less than that *required* for the stairway or ramp shaft if the passageway discharges from a *fire-isolated stairway* or ramp; or
- (b) in any other case - not less than 60/60/60.

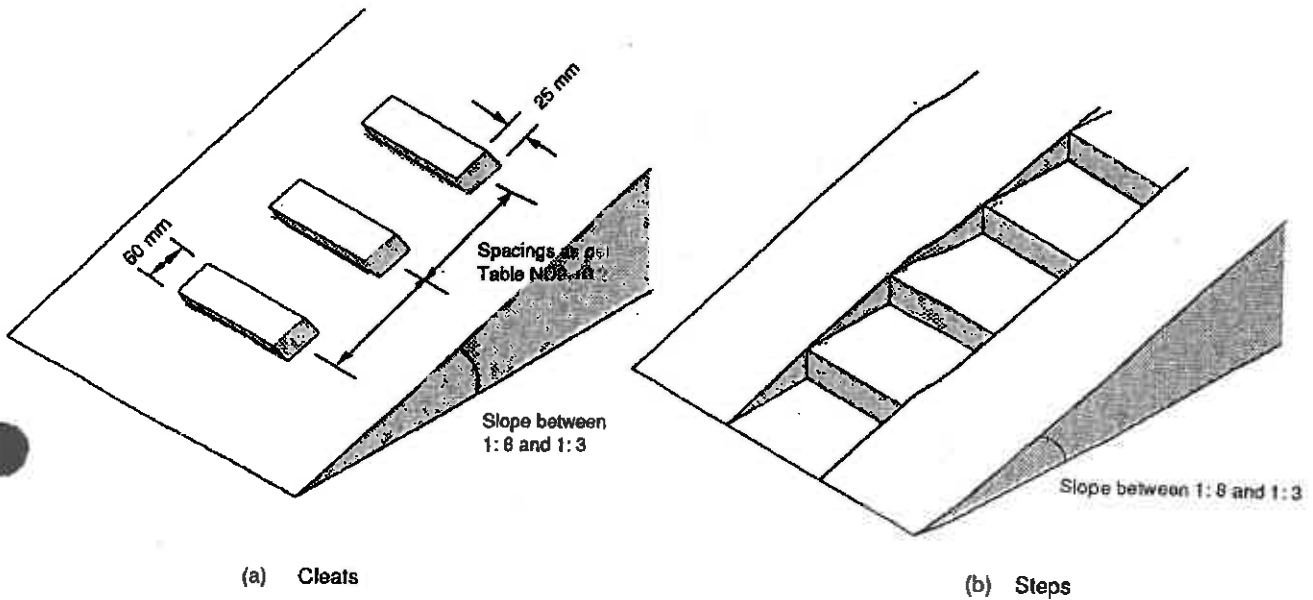

FIGURE ND2.10.2 EXAMPLES OF SERVICE RAMPS WITH CLEATS

ND2.12 Roof as open space

If an *exit* discharges to a roof of a building, the roof must -

- (a) have a FRL of not less than 120/120/120; and
- (b) not have any rooflights or other openings within 3 m of the path of travel of persons using the *exit* to reach a road or *open space*.

ND2.13 Treads and risers

ND2.13.1 Straight flights

- (a) A stairway must be suitable to provide safe passage in relation to the nature, volume and frequency of likely usage.
- (b) A stairway in any building (including a *sole-occupancy unit* in a Class 2 or 3 building or Class 4 part) satisfies (a) if it has -
 - (i) not more than 18 nor less than 2 risers in each flight, except in a Class 9 building subject to ND1.7(d);
 - (ii) subject to (ix), going and riser dimensions in accordance with Figure ND2.13.1 and Table ND2.13.1 that are constant throughout each flight;

- (iii) risers which do not have any openings that would allow a 100 mm sphere to pass through between the treads;
- (iv) treads which have a non-slip finish or a suitable non-skid strip near the edge of the nosings;
- (v) treads of solid construction (not mesh or other perforated material) if the stairway is more than 10 m high or connects more than 3 storeys;
- (vi) in a Class 9 building - not more than 36 successive risers and landings without a change in direction of at least 30°; and
- (vii) a cross fall of between 1:100 and 1:50 where the stairway is subject to wetting;
- (viii) treads not exceed the goings by more than 30 mm; and
- (ix) in a *sole occupancy unit* in a class 2 building or class 4 part, or where it is not part of a *required exit* and to which there is no normal access to the public, going and riser dimensions to Table DD1.1.

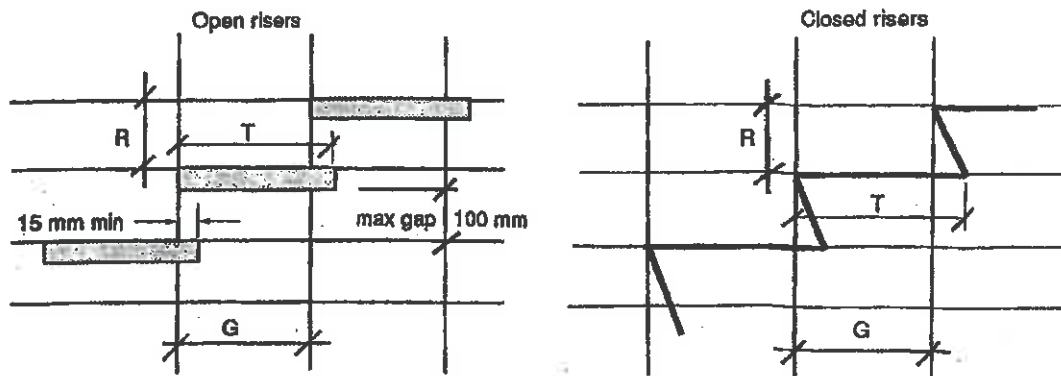

Note: R = Riser
 G = Going
 T = Tread

FIGURE ND2.13.1 MEASUREMENT OF RISER GOING AND TREAD

**TABLE ND2.13.1
 RISER DIMENSIONS (mm) TO MATCH GOING**

Pitch	GOING (mm)								
	250	260	270	280	290	300	310	320	330
37°	188								
36°	182	188							
35°	175	182	189						
34°	168	175	182	188					
33°	162	169	175	181	188				
32°	156	162	168	174	181	187			
31°	150	156	162	167	174	180	186		
30°		150	156	161	167	173	179	185	
29°			150	155	161	167	173	179	183
28°				150	155	160	165	170	175
27°					148	153	158	163	168
26°						146	151	156	161
25°								149	154
24°									147

Notes:

- Actual riser dimension may be selected to suit the inter landing height. However the value of the riser dimension must not be outside the maximum or minimum dimensions shown for each value of going.
- The dimensions shown within the outlined box are preferred because they are less strenuous for individuals on crutches or with minor disabilities.

ND2.13.2 Curved stairs

Curved stairs must comply with the relevant requirements of ND2.13.1 as well as the following:

- (a) For the purposes of satisfying Table ND2.13.1 or Table DD1.1 in the case of stairs in ND2.13.1 (ix), the going must be measured:
 - (i) along half way across the width of the stair where the clear width is less than 900 mm; and
 - (ii) 300 mm from each side of the stair where the clear width is 900 mm or more.
- (b) All steps must have the same uniform taper.
- (c) The going at the narrow end of the steps must be not less than 75 mm.
- (d) Winders are not permitted.

ND2.14 Landings

In a stairway -

- a) landings having a maximum slope of 1:50 may be used in any building to limit the number of risers in each flight and each landing must -
 - (i) be not less than 750 mm long measured 500 mm from the inside edge of the landing; and
 - (ii) have a non-slip finish throughout or a suitable non-skid strip near the edge of the landing where it leads to a flight of stairs below; and
- (b) in a Class 9a building -
 - (i) the area of any landing must be sufficient to move a stretcher, 2 m long and 600 mm wide, at an incline not more than the slope of the stairs, with at least one end of the stretcher on the landing while changing direction between flights; or
 - (ii) the stair must have a change of direction of 180°, and the landing a clear width of not less than 1.6 m and a clear length of not less than 2.7 m.

ND2.15 Thresholds

The threshold of a doorway must not incorporate a step or ramp at any point closer to the doorway than the width of the door leaf unless-

- (a) in patient-care areas in a Class 9a building, the door sill is not more than 25 mm above the finished surface of the ground, balcony or the like to which the doorway opens;

(b) in other cases -

- (i) the doorway opens to a road, open space or external balcony; and
- (ii) the door sill is not more than 190 mm above the finished surface of the ground, balcony, or the like, to which the doorway opens.

ND2.16 Balustrades

- (a) In a Class 2, 3, 4, 5, 6 or 9 building and a Class 7 building used as a public carpark, a continuous balustrade must be provided along the side of any stairway or ramp, or any corridor, hallway, balcony, bridge or the like, if -
 - (i) it is not bounded by a wall; and
 - (ii) the change in level is more than 1 m, except at the perimeter of a stage, rigging loft, loading dock, an area accessible only to maintenance staff, or the like.

(b) A balustrade required by (a) must prevent, as far as practicable-

- (i) children climbing over or through it;
- (ii) persons accidentally falling from the floor; and
- (ii) objects which might strike a person at a lower level accidentally falling from the floor surface.

(c) In low risk areas such as fire-isolated stairways, fire-isolated ramps or external stairways that are provided instead of fire-isolated stairways, other areas used exclusively for emergency purposes and other stairways and ramps (including access bridges and landings), where the change in level is not more than 2 m a balustrade satisfies (b) if -

- (i) the balustrade has a height of not less than 865 mm above the nosings of the stair treads and the floor of the landing, access bridge or the like; and
- (ii) the space between balusters or the width of any opening in the balustrade (including any openable window or panel) is not more than 100 mm except where the space between rails or the height of any opening is not more than 100 mm.

(d) At balconies a balustrade satisfies (b) if -

- (i) it has a height of not less than 930 mm above the balcony floor;
- (ii) the space between balusters or the width of any opening in the balustrade is not more than 100 mm except where the space between rails or the height of the opening is not more than 100 mm;

ND2 CONSTRUCTION OF EXITS

- (iii) all parts of the balustrade more than 150 mm and less than 760 mm from the floor or nosings are vertical or otherwise do not provide a toe-hold; and
 - (e) In stairways and ramps (including access bridges and landings) where the change in level is more than 2 m, a balustrade satisfies (b) if -
 - (i) it has a height of not less than 865 mm above the nosings of the stair treads and the floor of the landing, balcony, corridor, hallway, access bridge or the like;
 - (ii) the space between balusters or the width of any opening in the balustrade (including any openable window or panel) is not more than 100 mm except where the space between rails or the height of the opening is not more than 100 mm; and
 - (iii) all parts of the balustrade more than 150 mm and less than 760 mm from the floor or nosings are vertical or otherwise do not provide a toe-hold.
 - (f) A balustrade or other barrier in front of fixed seating in a mezzanine floor or balcony in a Class 9b building satisfies (b) if it complies with (d), or -
 - (i) it is not less than 700 mm in height above the mezzanine floor or balcony floor and a horizontal projection extends not less than 1 m outwards from the top of the balustrade; and
 - (ii) the space between balusters or the width of any opening in the balustrade is not more than 100 mm except where the space between rails or the height of the opening is not more than 100 mm.
- (iv) fixed at a height of not less than 700 mm above the nosings of stair treads in a Class 9b building that is used as a primary school;
 - (v) in any other case fixed at a height of not less than 865 mm above the nosings of stair treads and the floor surface of the ramp, landing, or the like; and
 - (vi) continuous between stair flight landings and have no obstruction on or above them that will tend to break a hand-hold.
- (c) Handrails in a Class 9a building must be provided along at least one side of every passageway or corridor used by patients, and must be -
 - (i) fixed not less than 50 mm clear of the wall; and
 - (ii) where practicable, continuous for their full length.

ND2.16 Fixed platforms, walkways and ladders

Fixed platforms, walkways, non-required stairways, handrails, balustrades and ladders must comply with AS 1657 in -

- (a) a Class 7 or Class 8 building, or part of a building; and
- (b) lift motor rooms, plant rooms, and the like.

ND2.19 Doorways and doors

A doorway serving as a *required exit*, forming part of a *required exit*, or in a patient-care area of a Class 9a building-

- (a) must not be fitted with a revolving door;
- (b) must not be fitted with a roller shutter or tilt-up door unless -
 - (i) it serves a Class 6, 7 or 8 building or part with a floor area not more than 200 m²;
 - (ii) the doorway is the *only required exit* from the building or part; and
 - (iii) it is held in the open position while the building or part is lawfully occupied;
- (c) must not be fitted with a sliding door unless -
 - (i) it leads directly to a road or open space; and
 - (ii) the door can be opened manually under a force of not more than 10 kg; and

ND2.17 Handrails

- (a) Except in a Class 7 or 8 building other than a *public carpark*, suitable handrails must be provided where necessary to assist and provide stability to persons using a ramp or stairway.
- (b) Handrails satisfy (a) if they are -
 - (i) located along at least one side of the ramp or flight of stairs;
 - (ii) located along each side if it is a Class 9b building that is used as an *early childhood centre* or as a *primary school*, or if the total width of the stairway or ramp is 2 m or more;
 - (iii) not more than 2 m apart in the case of intermediate handrails;

- (d) If fitted with a door which is power-operated -
- (i) it must be able to be opened by hand under a force of not more than 10 kg if there is a malfunction or failure of the power source; or
 - (ii) it must open *automatically* if there is a power failure or on the activation of a fire or smoke alarm anywhere in the part served by the door.

ND2.20 Swinging doors

A swinging door in a *required exit* or forming part of a *required exit* -

- (a) must not encroach-
 - (i) at any part of its swing by more than 500 mm on the *required* width of a *required* stairway, passageway or ramp, including the landings; and
 - (ii) when fully open, by more than 100 mm on the *required* width of the *required exit*, and

the measurement of encroachment in each case is to include door handles or other furniture or attachments to the door;
- (b) must swing in the direction of egress unless -
 - (i) it serves a building or part with a *floor area* not more than 200m², it is the *only required exit* from the building or part and it is fitted with a device for holding it in the open position; or
 - (ii) it serves a *sanitary compartment* or airlock (in which case it may swing in either direction); and
- (c) must not otherwise impede the path or direction of egress.

ND2.21 Operation of latch

A door in a *required exit*, forming part of a *required exit* or in the path of travel to a *required exit* must be readily openable without a key from the side that faces a person seeking egress, by a single-hand downward or horizontal pushing action on a single device which is located between 900 mm and 1200 mm from the floor, unless-

- (a) it serves a *vault*, strongroom, *sanitary compartment*, or the like; or
- (b) it serves only, or is within -
 - (i) a *sole-occupancy unit* in a Class 2 building or a Class 4 part;
 - (ii) a *sole-occupancy unit* in a Class 5, 6, 7 or 8 building with a *floor area* not more than 200 m²; or
 - (iii) a space which is otherwise inaccessible to persons at all times when the door is locked; or
- (c) it serves a bank or other occupancy where special arrangements for security are necessary and it can be immediately unlocked -
 - (i) by operating a fail-safe control switch, not contained within a protective enclosure, to actuate a device to unlock the door; or
 - (ii) by hand by a person or persons, specifically nominated by the owner, properly instructed as to the duties and responsibilities involved and available at all times when the building is lawfully occupied so that persons in the building or part may immediately escape if there is a fire or other emergency; or
- (d) it is fitted with a fail-safe device which *automatically* unlocks the door upon the activation of any *sprinkler system* or smoke or thermal detector system installed throughout the building.

ND2.22 Re-entry from fire-isolated exits

Doors must not be locked from inside a *fire-isolated stairway*, *fire-isolated ramp* or *fire-isolated passageway* enclosure to prevent re-entry to the *storey* or room it serves in -

- (a) a Class 9a building; or
- (b) a building more than 25 m in *effective height* unless all the doors are *automatically* unlocked by a fail-safe device upon the activation of a fire alarm, and at least at every fourth storey the doors are not able to be locked and a sign is fixed on it stating that re-entry is available.

ACCESS FOR PEOPLE WITH DISABILITIES

ND3.1 Application of Part

This Part applies to all Class 3, 5, 6, 7, 8 and 9 buildings.

ND3.2 Access to buildings

Access for people with disabilities must be provided to buildings as set out in Table ND3.2 by means of a continuous path of travel in accordance with AS 1428.1, or NZS 4121 and NZS 4122 -

(a) from the boundary of the allotment;

(b) from any carpark space on the allotment (whether within or outside the building)

(i) that is set aside for people with disabilities using the building; or

(ii) if there are no carpark spaces set aside for them, from any carpark area that serves the building; and

(c) from any other building on the allotment to which access for people with disabilities is required.

**TABLE ND3.2
REQUIREMENTS FOR ACCESS FOR PEOPLE WITH DISABILITIES**

CLASS OF BUILDING	ACCESS REQUIREMENTS
Class 3	To and within -
(a) If the building contains -	
more than 10 units up to 49 units	one sole-occupancy unit.
more than 49 but not more than 99	2 sole-occupancy units.
more than 99 units	3 sole-occupancy units.
(b) If accommodation is provided for more than 10 persons other than in sole-occupancy units -	
up to 49 beds	2 beds.
more than 49 but not more than 99	4 beds.
more than 99	6 beds.
(c) Common areas of buildings that are required to be accessible	the entrance floor and to all public areas on that floor.
Class 5 and 6.. .. .	To and within the entrance floor if its floor area is more than 500 m ² .
Class 7	To and within the entrance floor if the total floor area of the building is more than 3000 m ² .
Class 8	To and within the entrance floor if the total floor area of the building excluding any part used as a laboratory, is more than 1000 m ² .
AND	
Class 5, 6, 7 and 8	To and within any floor if irrespective of floor area, the floor is not more than 190 mm at the point of entrance above or below the adjacent finished ground level; and within any other floor to which vertical access by way of a ramp, step or kerb ramp, or passenger lift is provided.

TABLE ND3.2 Continued
REQUIREMENTS FOR ACCESS FOR PEOPLE WITH DISABILITIES

CLASS OF BUILDING	ACCESS REQUIREMENTS
Class 9a	To and within all areas normally accessible to the public, patients or staff.
Class 9b - An assembly building not being a school or an early childhood centre ..	To and within every room that accommodates more than 100 persons, and if fixed seating is provided, not less than 1 wheelchair space for each 200 seats, or part, with a minimum of 2 spaces; and within any other floor to which vertical access by way of a ramp, step or kerb ramp, or passenger lift is provided.
An early childhood centre	To and within every room used by children.

Note: The calculation of floor area and the number of persons accommodated are in accordance with ND1.13.

For the purposes of this Table, a double bed counts as 1 bed.

ND3.3 Parts of buildings to be accessible

- (a) Access for people with disabilities must be provided-
- (i) from the doorway at the entrance floor providing access to any *sanitary compartment required* for the use of people with disabilities; and
 - (ii) to areas normally used by the occupants, excluding any plantroom, commercial kitchen, cleaners' store room, maintenance accessway, rigging loft, or the like.
- (b) A path of travel providing *required* access must not include a stairway, turnstile, revolving door, escalator or other impediment which would prevent a person in a wheelchair using it.
- (c) Access, finishes and fittings, including passageways, ramps, step or kerb ramps, passenger lifts, signs, doorways and other parts of the building required by this Part must comply at least with the provisions of AS 1428.1, or NZS 4121 and NZS 4122, excluding any references to AS 1735.12.

ND3.4 Concessions

It is not necessary to provide access for people with disabilities -

- (a) to more than 30% of the public space in a restaurant, café, bar, function room, or the like, in a Class 6 or Class 9b building;
- (b) to a *mezzanine* floor or other space not regarded as a *storey* by definition;
- (c) to more than 1 car parking space for each 100 spaces in a *public carpark*; or
- (d) to any area if access would be inappropriate because of the particular purpose for which the area is used.

**NATIONAL
BUILDING
CODE
1990**

PUBLIC BUILDINGS AND GROUP DWELLINGS (CLASS 2 TO 9)

SECTION NE

**SERVICES AND
EQUIPMENT**

**Performance Requirements
Deemed-to-Satisfy Provisions**

- | | |
|------------|--|
| NE1 | Fire Fighting Equipment |
| NE2 | Smoke Control |
| NE3 | Lift Installations |
| NE4 | Emergency Lighting and Exit Signs |
| NE5 | Maintenance of Safety Installations |
| NE6 | Electricity |

CONTENTS

PERFORMANCE REQUIREMENTS

DEEMED-TO-SATISFY PROVISIONS

Part

NE1 Fire Fighting Equipment

- NE1.1 Application of Part
- NE1.2 Fire mains and water supply
- NE1.3 Riser main system
- NE1.4 Where hydrants are required
- NE1.5 Hose reels
- NE1.6 Sprinklers
- NE1.7 Portable fire extinguishers
- NE1.8 Fire and smoke alarms
- NE1.9 Fire control centres
- NE1.10 Fire precautions during construction
- NE1.11 Provision for special hazards

NE2 Smoke Control

- NE2.1 Smoke venting
- NE2.2 Exclusion of smoke from fire-isolated exits
- NE2.3 Natural smoke venting
- NE2.4 Air-handling systems
- NE2.5 Roof vents
- NE2.6 Smoke exhaust systems
- NE2.7 Pressurisation

NE3 Lift Installations

- NE3.1 Application of Part
- NE3.2 Stretcher facility in lifts
- NE3.3 Warning against use of lifts in fire or earthquake
- NE3.4 Emergency lifts

NE4 Emergency Lighting, Exit Signs and Warning Systems

- NE4.1 Application of Part
- NE4.2 Emergency lighting requirements
- NE4.3 Measurement of distance

Part

- NE4.4 Design and operation of emergency lighting
- NE4.5 Exit signs
- NE4.6 Direction signs
- NE4.7 Class 2,3 and 4 buildings: Exemptions
- NE4.8 Design and operation of exit signs

NE5 Maintenance of Safety Installations

- NE5.1 Application
- NE5.2 Maintenance requirements

NE6 Electrical Work

- NE6.1 Safety
- NE6.2 Amenity

Specifications

- Specification NE1.2
Fire Mains and Water Supply Services

- Specification NE1.6
Fire Sprinkler Systems

- Specification NE1.8
Fire Detection and Alarm Systems

- Specification NE1.9
Fire Emergency Control Centres

- Specification NE2.4
Air Handling Systems in Buildings

- Specification NE2.6
Smoke Exhaust Systems

PERFORMANCE REQUIREMENTS

OBJECTIVES

A building must be so designed and constructed that the following objectives are fulfilled:

NEP1 Fire Fighting Equipment

Having regard to the size and use of the building and its Type of construction, adequate in-built and external fire protection services must be provided to-

- (a) restrict fire growth to the compartment of origin;
- (b) prevent fire spread to adjoining buildings or allotments; and
- (c) facilitate the fighting of fire to minimise damage to the building and its contents.

NEP2 Smoke Control

Air-handling systems installed in a building must-

- (a) provide suitable air for the health and safety of the occupants; and
- (b) incorporate reasonable measures to minimise the spread of smoke in the event of fire to escape paths from the building, to other compartments and to enable access by fire fighters.

NEP3 Lift Installations

Lifts where provided must have regard to the nature of any emergency -

- (a) to assist in the evacuation of the occupants; and
- (b) to facilitate access by fire-fighting and other emergency personnel.

NEP4 Emergency Lighting and Exit Signs

- (a) Emergency lighting and exit signs must be provided where necessary to facilitate safe egress in an emergency upon failure of the normal lighting.
- (b) Suitable alarm systems must be provided to alert occupants of an emergency, initiate *automatic* counter measures and summon emergency personnel.

NEP5 Maintenance of Safety Installations

Equipment, installations and components critical to the safety of the building or the occupants must be adequately maintained in such condition that will enable their proper performance.

NEP6 Electrical Work

All electrical work must meet the following objectives -

- (a) It must prevent electrocution, burns or fire.
- (b) It must satisfy the reasonable expectations of the users by ensuring that it is adequate for their intended use, both current and anticipated.

REQUIRED PERFORMANCE

NEP1.1 Active fire fighting

In determining the type and extent of active fire fighting systems that must be provided for a building the following must be taken into account -

- (a) the class of occupancy;
- (b) proximity to *fire-source features*;
- (c) Type of construction in relation to fire resistance;
- (d) size of fire compartments
- (e) *effective height*;
- (f) the flow rate and pressure of available water supply;
- (g) the capacity of the Fire Brigade or other fire fighting organisation that serves the area where the building is located; and
- (h) the technical resources available locally to satisfactorily instal and regularly test and maintain the active fire fighting system.

Fire and smoke alarms

Reliable detection and warning systems must be installed for *automatic* operation in the event of a fire or generation of unacceptable levels of smoke. In the case of -

- (a) all tall buildings;
- (b) buildings of medium size or larger, frequented by the public and where flammable and consumer goods are displayed; and
- (c) occupancies of excessive hazard of moderate size or larger,

the detection systems on initiation must automatically activate suitable fire fighting systems.

NE SERVICES AND EQUIPMENT

NEP2.1 Smoke control

Air handling systems in buildings must be no more complex than what is given in the Deemed-to-Satisfy Provisions unless satisfactory evidence is produced to show that the level of expertise available on an on-going basis would be adequate to keep them regularly tested serviced and maintained in a sound condition. Air handling systems must be such that smoke is not transported from the compartment or locality of origin to escape paths and other fire compartments or storeys to a concentration that might affect the safety of the occupants or hinder the work of fire fighters.

NEP3.1 Lift installations

Lift installations in tall buildings must be capable of transporting stretchers without discomfort. Effective warning must be displayed against the use of lifts during fires or earthquakes. In very tall buildings at least one lift must be such that it can be safely operated during emergencies such as fires and be switched during the emergency for operation by only emergency personnel such as fire fighters.

NEP4.1 Emergency lighting

In moderately tall or higher residential buildings, in other than small buildings where the occupants are transient, and in all other buildings emergency lighting must be provided to clearly indicate exits and the doors guarding such exits must be identifiably marked. Such buildings must also have emergency lighting available to facilitate the occupants to reach the exits without confusion and to safely negotiate the exits until they can be in a road or open space. The route to the exits must be identifiably marked. In hospitals and in areas where emergency personnel operate, there must be adequate emergency lighting to avoid patient trauma or hardship and to permit the staff to carry out emergency functions.

All emergency lighting must automatically operate in the event of any failure of normal lighting for a period long enough for the evacuation of all the occupants, plus a margin. Such lighting must give an adequate level of illumination to allow evacuation without hindrance.

NEP6.1.1 Electrical safety

The supply system must:

- (a) have suitable devices of adequate interruptive duty to automatically shut off the supply in the event of a fault or overload. Such devices must allow easy reinstatement of the supply after interruption;
- (b) have devices which are clearly identified and easily reached to isolate live parts from the incoming supply;
- (c) be constructed and installed to ensure that no part of the system can be subjected to a voltage higher than that for which the system was designed;
- (d) when the neutral of the supply is earthed, have socket outlet or plug - socket adaptor construction which would ensure that the live, neutral and earth conductors can only be connected to the corresponding live, neutral and earth conductors of the plug;
- (e) where it is a common supply system be so compatible that the safety features of the system itself are not impaired;
- (f) where it has a multiple earthed neutral system, have an adequate connection between the neutral conductor and earth at each consumer's premises;
- (g) be adequately protected against damage arising from exposure to weather, water or excessive dampness mechanical loads and other such agents expected under normal conditions of use; and
- (h) ensure that the main switch is normally accessible only to the occupants.

NEP6.1.2 Amenity

The supply system must have an adequate capacity to serve the reasonable anticipated needs of the users.

DEEMED-TO-SATISFY PROVISIONS

FIRE-FIGHTING EQUIPMENT

NE1.1 Application of Part

This Part applies to Class 2,3,4,5,6,7,8 and 9 buildings.

NE1.2 Fire mains and water supply

- (a) Where a permanently charged *fire main* and water supply system are available these must provide a continuous supply of water at sufficient pressures and rates of flow to enable effective fire fighting on any adjoining building. The system must in addition have *hydrants* located free of obstructions at appropriate intervals. The location of the *hydrants* must be suitably marked for ease of identification by the fire service.
- (b) In the case of buildings with a *rise* of 5 storeys or more where an adjoining permanently charged *fire main* and water supply system is not available, adequate on *site* water storage and suitable fire pumps must be provided to give the rates and pressures of flow for fire fighting, as per NZS 4510. The system provided may in addition serve any *required sprinkler system* or other *required water type* in-built fire protection system.
- (c) A *fire main* and water supply system must comply with Specification NE1.2.

NE1.3 Riser main system

Riser mains to NZS 4510 must be provided in buildings with a *rise* of 5 storeys or more. In buildings with a *rise* of up to 8 storeys a *charged dry riser main system* is allowable; for taller buildings a *wet riser main system* is required. Any *wet riser main system* must be connected to a permanently charged *fire main*. In buildings with a *rise* of more than 8 storeys a dedicated *automatic* starting fire pump or pumps in accordance with NZS 4510 must be installed in the system to boost the pressure and/or the rates of flow to the values *required* by the Standard.

NE1.4 Where hydrants are required

(a) General

One or more *hydrants* must be provided -

- (i) in each *storey* with a *floor area* of more than 750 m²;
- (ii) in every *storey* if the building contains 5 *storeys* or more; and
- (iii) on the roof if the building has a *rise* of more than 8 *storeys* except on
a roof having a pitch of more than 10°; or

a roof of a plant room or other subsidiary structure on the main roof.

(b) External hydrants

The configuration and location of a building and of adjacent external *hydrants* must be such that the farthest point on the *storeys* to which direct access from a street is available for the fire service, must be within reach of a 6m spray from the nozzle of a 120 m fire hose.

External *hydrants* must be located -

- (i) not closer than 6 m from a building unless protected from it with a wall having a FRL of not less than 60/60/30 extending at least 2 m each side and 3 m above the *hydrant* outlets; and
- (ii) not more than 20 m unobstructed distance from hard standing access for a fire pump appliance.

(c) Internal hydrants

- (i) The *riser main* system must provide for sufficient number and disposition of internal *hydrants* such that any point on any *storey* is within reach of a 6 m spray from the nozzle of a 45 m fire hose.
- (ii) Internal *hydrants* must be located on the floor not more than 4 m from a *required exit*, or in a *required* stairway, passageway or ramp so as not to encroach on the *required* width of the *exit*.

- (d) *Hydrants* for the ground floor of a building may be external *hydrants*.

NE1.5 Hose reels

Hose reels must be installed in buildings as listed in Table NE1.5 and must -

(a) not be located -

- (i) within a fire-isolated *exit*; or
- (ii) so that the hose will need to pass through the doorway fitted with a fire or smoke door; except a door to a *sole-occupancy unit* in a class 2, 3 or 4 building;

(b) be located -

- (i) not more than 4 m from a *required exit* on each floor of the building (including the ground

**TABLE NE1.5
REQUIREMENTS FOR FIRE HOSE REELS**

OCCUPANCY	FIRE HOSE REELS REQUIRED-
Class 2	if more than 4 residential storeys contained.
Class 3	if more than 2 residential storeys contained.
Class 5,6,7,8 or 9b	(a) any storey if floor area of storey more than 750 m ² ; or (b) if more than 3 storeys contained.
Class 9a	all buildings.
AND All Classes	wherever an internal hydrant is required

floor) and adjacent to any hydrants required within the building; and

- (ii) so that the nozzle end of a fully extended fire hose fitted to the reel and laid to avoid any partitions or other physical barriers will reach every part of the floor;
- (c) serve only the floor on which they are located except that a hose reel may serve a sole-occupancy unit of not more than 2 storeys, or a unit with a mezzanine floor, if the hose reel is located at the level of egress from that unit; and
- (d) comply with NZS 4504 and NZS 4503.

NE1.6 Sprinklers

A required sprinkler system must-

- (a) comply with Specification NE1.6; and
- (b) be installed in buildings as listed in Table NE1.6.

NE1.7 Portable fire extinguishers

Portable fire extinguishers containing an extinguishing agent suitable for the risk being protected must be installed in accordance with NZS 4503 in all buildings except -

- (a) a Class 2 or 3 building; or
- (b) in the case of water-type extinguishers, a building or part of a building served by a fire hose reel.

**TABLE NE1.6
REQUIREMENT FOR SPRINKLERS**

OCCUPANCY	WHEN SPRINKLERS ARE REQUIRED
Occupancies of excessive hazard	in fire compartments with (a) a floor area of more than 2000 m ² ; or (b) a volume more than 10000 m ³ .
Class 6	in fire compartments with- (a) a floor area of more than 2000 m ² ; or (b) a volume more than 12000 m ³ .
All Classes except open-deck carparks	in buildings more than 25 m in effective height or with a rise in excess of 8 storeys. The water supply for the sprinkler system must be to Class A.
Carparks, other than open-deck carparks	(a) if accommodating more than 40 vehicles; (b) if incorporating structural steel members with a FRL less than 60/-/-.

Note: (a) Occupancies of excessive fire hazard are listed in the annexure to Specification NE1.6.

(b) See NC 2.3 for requirements for sprinklers in large isolated buildings.

Table NE1.7 shows the commonly available portable extinguishers and their selection for appropriate class and type of fires.

NE1.8 Fire and smoke alarms

NE1.8.1 A suitable automatic fire and smoke alarm system complying with Specification NE1.8 must be installed in -

- (a) each storey if the building has a rise of 5 to 8 storeys;
- (b) a Class 3 building -
 - (i) if rooms for residential use are above a height of 2 storeys; or
 - (ii) in a special accommodation house or home for the aged, children, sick or physically or mentally disabled persons or the like; and
- (c) a Class 9a building -
 - (i) if more than 20 patients are accommodated in wards or bedrooms; or
 - (ii) in a clinic or day surgery, having areas where surgical procedures are performed at a height of 3 storeys or more.

**TABLE NE1.7
PORTABLE FIRE EXTINGUISHER SELECTION CHART**

Type of Extinguisher Class and Type of Fire		CONTENTS OF EXTINGUISHER ARE			
		Electrically Conductive		Electrically Non-Conductive	
		WATER	FOAM	DRY CHEMICAL	CARBON DIOXIDE
A	Ordinary combustibles (wood, paper, etc)	✓ YES MOST SUITABLE	✓ YES	✓ YES	✓ YES
B	Flammable liquids	X NO	✓ YES SPECIAL FOAM REQUIRED FOR ALCOHOL-TYPE FIRE	✓ YES	✓ YES
C	Flammable gases	X NO	X NO	✓ YES	✓ YES
D	Combustible metals	X NO	X NO	X NO	X NO
USE SPECIAL PURPOSE EXTINGUISHERS ONLY					
(E)	Fire involving live electrical equipment	X NO	X NO	✓ YES	✓ YES

NE 1.8.2 A manually operated evacuation alarm system to the relevant provisions of Specification NE1.8 must be provided in any building of -

- (a) Class 3 containing more than 20 beds where the rooms for residential use are located up to a height of only 2 storeys.
- (b) Class 5 with a rise of 3 or 4 storeys and a storey floor area of more than 500 m²;
- (c) Class 6, 7 or 8 excluding a public carpark with a rise of up to 4 storeys and a storey floor area of more than 500 m²;
- (d) Class 9(a) with a rise of up to 4 storeys ; and
- (e) in the residential part of a school accommodating more than 20 persons at a level above or below the entrance level. Also in all other class 9b buildings (including schools) with a rise of up to 4 storeys and a storey floor area of more than 250 m²; and

Type A, B or C alarm systems are acceptable for Class 3 buildings, Type B or C for Class 6 and 9 other than schools, and a Type A system for Class 7 and 8 buildings and schools.

NE1.9 Fire control centres

A fire control centre facility in accordance with Specification NE1.9 must be provided in-

- (a) all buildings with an effective height of more than 25m; and

- (b) a Class 6,7,8 or 9 building with a total floor area more than 18000 m².

NE1.10 Fire precautions during construction

In a building under construction-

- (a) not less than one fire extinguisher to suit Class A, B and C fires and electrical fires must be provided at all times on each floor adjacent to each required exit or temporary stair or exit and;
- (b) after the building has reached an effective height of 12 m-
 - (i) the required hydrants and hose reels must be operational in at least every storey that is covered by the roof or the floor structure above, except the 2 uppermost storeys; and
 - (ii) any required fire brigade booster connection must be installed.

NE1.11 Provision for special hazards

Suitable additional provision must be made if special problems of fighting fire could arise because of-

- (a) the nature or quantity of materials stored, displayed or used in a building or on the allotment; or
- (b) the location of the building in relation to a water supply for fire fighting purposes.

SMOKE CONTROL

NE2.1 Smoke Venting

Buildings must have a system to control smoke as listed in Table NE2.1.

TABLE NE2.1 REQUIREMENTS FOR SMOKE CONTROL	
BUILDING	SYSTEM
<p><i>Sole-occupancy units</i> in Class 2, 3 or 4 buildings.</p> <p>Single storey buildings where the floor area of a fire compartment or storey does not exceed 500 m² and is not served by a central mechanical ventilation plant.</p>	No requirement
Single storey buildings, or the top storey of multistorey buildings	Either: (a) Windows, panels or the like in accordance with NE2.3; (b) Roof vents in accordance with NE2.5; or (c) Smoke exhaust systems in accordance with NE2.6.
Multistorey buildings excluding the top storey	Windows, panels or the like in accordance with NE2.3.
Class 6 buildings with enclosed malls exceeding 40 m in length.	Smoke exhaust systems in accordance with NE2.6

NE2.2 Exclusion of smoke from fire-isolated exits

Smoke must be excluded from fire-isolated exits in accordance with Table NE2.2.

EXIT TYPE	REQUIREMENT
A required fire-isolated stairway serving any storey above an effective height of 25 m.	Either (a) a pressurisation system in accordance with NE2.7; or (b) open access ramps or balconies in accordance with ND2.5.
A required fire-isolated stairway serving 3 or more below ground storeys.	
A required fire-isolated ramp or fire-isolated passageway having a path of travel more than 60 m along it to a road or open space.	
<p>Note: A below ground storey is one where egress involves an upward vertical climb of more than 1.5m.</p>	

NE2.3 Natural Smoke Venting

Windows, doors, panels, or the like, provided to control the movement of smoke must-

- (a) be as evenly distributed as practicable; and
- (b) be readily openable, except that if windows and panels or the like are provided on the ground level storey, they need only be shatterable.

- (ii) a fire detection and alarm system which complies with AS 1670 or NZS 4512; or
- (iii) smoke detectors spaced not more than 30 m apart and 15 m from any smoke curtain and with not less than one detector for each 500 m² of floor area; or
- (iv) rate of rise heat detectors spaced not more than 15 m apart and 7.5 m from any smoke curtain and with not less than one detector for each 250 m² of floor area.

NE2.4 Air-handling Systems

If an air-handling system is installed in a building it must operate in accordance with Specification NE2.4.

NE2.6 Smoke Exhaust Systems

A required smoke exhaust system must comply with Specification NE2.6.

NE2.5 Roof Vents

Required roof vents must comply with AS 2665, except that-

- (a) smoke curtains may divide the space below the roof into compartments with area not more than 1500 m²;
- (b) all roof vents within the same compartment must open at the same time; and
- (c) roof vents must be activated by-
 - (i) except in a Class 7 or 8 building, a sprinkler system if it is installed throughout the building; or

NE2.7 Pressurisation

A required pressurisation system must-

- (a) comply with AS 1668.1, except that instead of the criterion of 50 Pa pressure differential across each door when all doors are closed it must be 25 Pa;
- (b) not allow openable windows or other openable devices (other than necessary doorways, pressure-controlled relief louvres and windows openable by a key) in the stairway, ramp or passageway; and
- (c) not serve more than one fire-isolated exit system and not form part of any other air-handling system.

LIFT INSTALLATIONS

NE3.1 Application of Part

This Part applies to Class 2, 3, 4, 5, 6, 7, 8 and 9 buildings.

NE3.2 Stretcher facility in lifts

- (a) If passenger lifts are installed in any building with an *effective height* of more than 25 m, at least one lift serving all *storeys* of the building must have a stretcher facility in accordance with (b).
- (b) A lift *required* to comply with NE3.2(a) or NE3.4(b) must accommodate a raised stretcher with a patient lying on it horizontally by providing a clear space 600 mm wide x 2000 mm long x 1200 mm high above the floor level.

NE3.3 Warning against use of lifts in fire or earthquake

A warning sign must-

- (a) be displayed where it can be readily seen-
- (i) near every call button panel for a passenger lift or group of lifts throughout a building; except

- (ii) a small lift such as a dumb-waiter or the like that is for the transport of goods only; and

- (b) comply with the details and dimensions of Figure NE3.3 and consist of-

- (i) incised, inlaid or embossed letters on a metal, wood, plastic or similar plate securely and permanently attached to the wall; or

- (ii) letters incised or inlaid directly into the surface of the material forming the wall.

NE3.4 Emergency lifts

- (a) Among the lifts serving every *storey* of a building with an *effective height* of 75 m or more, at least one must be capable of being used as an emergency lift.

- (b) An emergency lift *required* by (a) must-

- (i) Comply with AS 1735.2;

- (ii) be of sufficient size to take a stretcher facility in accordance with NE3.2(b); and

- (iii) have a rating of at least 612 kg.



FIGURE NE3.3 WARNING SIGN FOR PASSENGER LIFTS

EMERGENCY LIGHTING, EXIT SIGNS AND WARNING SYSTEMS

NE4.1 Application of Part

This Part applies to Class 2, 3, 4, 5, 6, 7, 8 and 9 buildings.

NE4.2 Emergency lighting requirements

An emergency lighting system must be installed-

- (a) in every *fire-isolated stairway, fire-isolated ramp or fire-isolated passageway* located in Class 2 buildings of 5 stories or more, Class 3 buildings containing 30 beds or more, a building with Class 4 parts located at or higher than 15 m effective height, and in all Class 5, 6, 7, 8 and 9 buildings;
- (b) in every storey of a Class 5, 6, 7, 8 or 9 building where the storey has a floor area more than 500 m²-
- (i) in every passageway, corridor, hallway, or the like, which is part of the path of travel to an exit;
- (ii) in any room having a floor area more than 250 m² if it does not open to a corridor or space which has emergency lighting;
- (c) in every passageway, corridor, hallway, or the like, having a length of more than 6m from the entrance doorway of any *sole-occupancy unit* in a Class 2 building of 5 stories or more, in a Class 3 building containing 30 beds or more, in a Class 4 part located at or above 15 m effective height, to the nearest doorway opening directly to-
- (i) a *fire-isolated stairway, fire-isolated ramp or fire-isolated passageway*;
- (ii) an external stairway serving instead of a smoke or *fire-isolated stairway* under ND1.8;
- (iii) an external balcony leading to a *fire-isolated stairway, fire-isolated ramp or fire-isolated passageway*; or
- (iv) a road or open space;
- (d) in every required non-fire isolated stairway, ramp or passageway connecting more than 3 consecutive storeys in other than Class 2 buildings;
- (e) in a *sole-occupancy unit* in a Class 5, 6, or 9 building if -
- (i) the floor area of the unit is more than 500 m²; and
- (ii) an exit from the unit does not open to a road or open space or to an external stairway, passageway, balcony or ramp, leading directly to a road or open space;
- (f) in every room or space to which there is public access in every storey in a Class 6 or 9b building where-
- (i) the floor area in that storey is more than 1000 m²;
- (ii) any point on the floor of that storey is more than 30 m from the nearest doorway opening directly to a stairway, ramp, passageway, road or open space;
- (iii) egress from that storey involves a vertical upward climb within the building of more than 1.5m; or
- (iv) the storey provides a path of travel from any other storey required by (i), (ii), or (iii) to have emergency lighting;
- (g) in a Class 9a building-
- (i) in every passageway, corridor, hallway, or the like, serving a ward area or patient treatment room; and
- (ii) in every ward area or patient treatment room having a floor area of more than 200 m²; and
- (h) in every required fire control centre.

NE4.3 Measurement of distance

Distances, other than vertical rise, must be the shortest measurement along the corridor or the path of travel whether by straight lines, curves or a combination of both.

NE4.4 Design and operation of emergency lighting

- (a) Emergency lighting systems must-
- (i) be automatic in operation;
- (ii) provide sufficient illumination without undue delay for safe evacuation of all areas of the building where it is required;
- (iii) if it is a central system, be suitably protected from damage by fire; and
- (iv) operate without interruption for a minimum of 1 hour.

- (b) Emergency lighting in accordance with AS 2293 or NZS 6742 satisfies (a).

NE4.5 Exit signs

Exit signs must be installed and be clearly visible to persons approaching the *exit*, on or near-

- (a) every door providing direct egress from a *storey* to-
- (i) an enclosed stairway, passageway or ramp serving as a *required exit*;
 - (ii) an external stairway, passageway or ramp serving as a *required exit*; and
 - (iii) an external access balcony leading to a *required exit*;
- (b) every door from an enclosed stairway, passageway or ramp at every level of discharge to a road or *open space*;
- (c) every *horizontal exit*; and
- (d) every door serving as, or forming part of, a *required exit*.

NE4.6 Direction signs

If the *exits* will not otherwise be readily apparent to persons occupying or visiting the building, *exit* signs with directional arrows must be installed in appropriate positions in corridors, hallways, lobbies, and the like, indicating the direction to a *required exit*.

NE4.7 Class 2, 3 and 4 buildings: Exemptions

NE4.5 does not apply to-

- (a) a Class 2 building in which every door referred to is clearly and legibly labelled on the side remote from the *exit* or balcony-
- (i) with the word "EXIT" in capital letters 25 mm high in a colour contrasting with that of the background; or
 - (ii) by some other suitable method; and
- (b) an entrance door of a Class 2, 3 or 4 *sole-occupancy unit*.

NE4.8 Design and operation of exit signs

- (a) Every *required exit* sign must-
- (i) be clear and legible and have letters and symbols of adequate size;
 - (ii) be illuminated at a level sufficient for it to be clearly visible at all times when the building is occupied by any person having the right of legal entry to the building;
 - (iii) be installed so that if the normal power supply fails, emergency illumination is provided to the sign in the case of those buildings covered by NE4.2; and
 - (iv) if illuminated by an emergency lighting system incorporating wiring and a power source, comply with NE4.4.
- (b) *Exit* signs in accordance with AS 2293 or NZS 6742 satisfy (a).

MAINTENANCE OF SAFETY INSTALLATIONS

NE5.1 Application of Part

This Part applies to Class 2, 3, 4, 5, 6, 7, 8, and 9 buildings.

NE5.2 Maintenance requirements

Safety installations in buildings must be adequately maintained to the requirements of Table NE5.2.

**TABLE NE5.2
SCHEDULE OF MAINTAINED ITEMS**

ITEM TO BE INSPECTED OR TESTED	NATURE OF INSPECTION AND/OR TEST, AND FREQUENCY
1. OPENING PROTECTION	
<i>A required fire door, fire window, fire shutter or smoke door</i>	Operate and inspect for compliance with the provisions of Part NC3 and Specification NC3.4 Monthly
2. MEANS OF EGRESS	
(a) <i>Exits and paths of travel including doors, doorways and exit signs</i>	Inspect to ensure compliance with Section ND Monthly
(b) <i>Required handrails and balustrades</i>	Annually
(c) <i>Arrangements for safe egress in buildings with special security provisions</i>	Monthly
3. SIGNS	
(a) <i>Signs concerning use of lifts in the event of fire</i>	Inspect for legibility and installation in compliance with Part NE4 Annually
(b) <i>Exit sign illumination</i>	
<i>Internally illuminated signs</i>	Check that the lamp matches the approved lamp rating marked on the sign fitting Monthly
<i>Externally illuminated signs</i>	Check that the illumination is adequate Monthly

4. EMERGENCY LIGHTING

Required emergency lighting

- (a) Operate in conditions of simulated failure of power to the distribution board concerned and check for compliance with the provisions of Part NE4

Monthly

- (b) Where batteries are involved - Test and inspect as prescribed in AS 1670 as though they are installed pursuant to the provisions of that Standard or where AS 1670 is not relevant, test or inspect as appropriate

Monthly

- (c) Check battery charger for correct operation

Monthly

5. FIRE-FIGHTING SERVICES & EQUIPMENT

- (a) *Required portable fire extinguishers*

As prescribed in NZS 4503

- (b) *Required fire hose reels*

As prescribed in NZS 4503

- (c) *Required hydrants and riser main system*

As prescribed in NZS 4510

6. SPRINKLERS

- (a) *Required sprinkler system*

As prescribed in NZS 4541

- (b) Plans containing reference information

Inspect for presence and legibility to comply with NZS 4541

7. AIR-HANDLING SYSTEMS

- (a) Simulate activation of detectors

Operate and check for correct operation in accordance with Specification NE2.4 and NE2.6. Ensure that the system is left in correct operating condition

As in NZS 4512

- (b) Detectors

Test and inspect as though they are prescribed for installations under NZS 4512

Associated batteries

Check battery charger for correct operation

As in NZS 4512

- (c) Fire situations

Check to ensure compliance with AS 1668.1

Annually

- (d) Fire-control panels

Test and inspect as though the panel is installed as a Fire Indicator Board under NZS 4512

As in NZS 4512

(e) Pressurising of stairs, ramps and passageways	Operate, test and inspect to ensure compliance with AS 1668.1
	Monthly
8. MANUAL FIRE ALARMS	Operate to see if in working order
	As in NZS 4561
9. AUTOMATIC FIRE ALARMS	
(a) <i>Required automatic</i> alarms	As prescribed in NZS 4512
(b) Special situations and precautions and outdoor applications	Inspect for compliance with NZS 4512
10. LIFTS	
Lifts and associated equipment for operation in event of emergency	Operate under simulated emergency conditions and check for compliance with the provisions of NE3
	Quarterly
11. STRUCTURAL FIRE PROTECTION	
Compartmentation and fire protection of structural members	Ascertain that any work performed or any occurrence, accidental or otherwise, has not resulted in any reduction in the FRL or other fire protection provision of any part of the building installed as required
	Annually

ELECTRICAL WORK

NE6.1 Safety

NE6.1.1 General Requirements

All electrical wiring and installations in or on any Class 2 to 9 building must ensure safety from electric shock and fire. This requirement is satisfied if all electrical work associated with the building is done to comply with AS 3000 - Electrical installations - buildings, structures and premises (known as the SAA Wiring Rules). The capacity of the system must allow for the long term anticipated requirements of the occupants.

NE6.1.2 Plug and power sockets

Plug and power sockets must:

- (a) have their individual switch;
- (b) be located so that
 - (i) cords and cables need not be taken across doorways;
 - (ii) trailing cords and cables do not have to cross circulation routes;

- (c) not be located behind door-swings; and
- (d) in the kitchen in Class 2, 3 and 4 buildings be located 250 mm above worktops at the back of benches or on a return wall where it exists.

NE6.1.3 Meter and distribution board

The meter must be located in a position from which it can easily be read. If the main switches and circuit breakers/fuses are not located with the meter they must be located at a height of not less than 1.8 m from the floor where they can be found easily in the dark.

NE6.2 Amenity

NE6.2.1 Light switch layout

- (a) The layout of light switches in Class 2, 3 or 4 buildings must follow the main night time circulation routes such as from the entrance hall to the living area to the bed-rooms to the bathroom and toilet. Crossing any major space in the dark must be avoided. The switches must be located close to door openings.
- (b) All stairs must have two-way switching at the top and the bottom.

FIRE MAINS AND WATER SUPPLY SERVICES

1. Scope

This Specification refers to *fire mains* and water supply services for fire-fighting equipment in buildings.

2. General requirements

A *fire main* must-

- (a) be capable of supplying water at the flow rates and pressures necessary for the satisfactory operation of the *required* fire-fighting equipment;
- (b) not incorporate plastic pipes above ground; and
- (c) not be used for other than fire-fighting purposes, except a *fire main* serving only hose reels may be connected to a metered supply if-
 - (i) the *required* flow rate and pressure can be maintained at the most hydraulically disadvantaged hose reel;
 - (ii) the water meter and street supply to the allotment have a nominal diameter of not less than 32 mm;
 - (iii) water supply pipework reticulation arrangements comply with figure 2 or a similar arrangement; and
 - (iv) any system valve which can isolate flow in the *fire main* is secured in the open position by a padlocked metal strap.

In buildings with a *sprinkler system* with a dual supply to Class A of NZS 4541 the water supply to any *wet riser main system* and/or hose reels may be taken from one of those supplies provided the rates of flow and pressures are adequate for both or all three purposes.

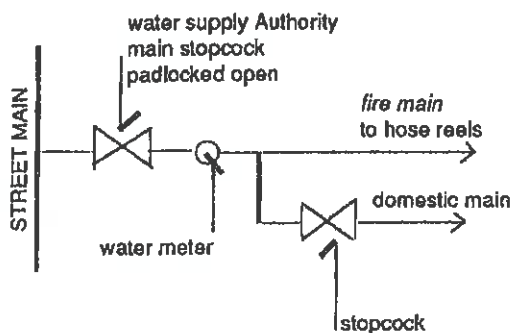

FIGURE 2 WATER SUPPLY RETICULATION:
COMBINED SERVICES

3. Water supplies for sprinkler systems

All water supplies for *sprinkler systems* must satisfy the requirements of NZS 454.1. Further -

- (a) a Class C single supply system must comprise -
 - (i) a street main which may be boosted by a diesel fire pump unit;
 - (ii) on-site storage or any source allowed by the Standard; or
 - (iii) a combined supply from two street mains which individually are inadequate; and
- (b) a Class A dual supply system must include -
 - (i) a street main which may be boosted by a diesel fire pump or, any other primary source; and
 - (ii) a separate on-site storage or other source allowed by the Standard, with an independent electric or diesel fire pump.

4. Fire pump enclosures

Fire pumps must be located in a room or enclosure which has a FRL of not less than 60/60/30 and is -

- (i) within the building; or
- (ii) external but not within 6 m of the building and any *fire-source feature*.

5. Booster and charged dry riser main connections and cabinets

- (a) Each *fire brigade booster connection* and the fire service inlet connection for a *charged dry riser main system* must be in locked cabinets accessible only to the fire service. If the system is fitted with a pressure gauge, the gauge must comply with AS 1349, and have a full scale reading of not less than 25% more than the pressure to which the system has been hydrostatically tested.
- (b) Cabinets may be located-
 - (i) at the *external wall* of a building if they are within sight of the main entrance and for Class 6, 7, 8 or 9b buildings, separated from the building by construction having a FRL of not less than 80/60/30 for not less than 2 m each side of and above the top of the cabinet;

OCCUPANCIES OF EXCESSIVE FIRE HAZARD

This annexure contains a graded list of examples of excessive fire hazard. The examples do not cover all possibilities and therefore there could be many other occupancies of excessive fire hazard. The Fire Authority having jurisdiction must be consulted in case of any doubt about occupancies not included in this Annexure.

ORDINARY HAZARD OCCUPANCIES

Group III Special

Flash fires are likely to occur in these occupancies. These include the following:

Chemical works and chemists (manufacturing or analytical) producing or using flammable solids, liquids, dusts and the like	Exhibitions
Copra kilns	Fibre glass products manufactures
Cork factories	Film and television studios
Cotton mills (preparatory processes)	Flax and hemp scutch mills
	Flax, jute and hemp mills (preparatory processes)
Distilleries (stillhouses)	Match factories
	Oil mills (crushing and solvent extraction)

EXTRA HIGH HAZARD OCCUPANCIES

Process risks

Examples of extra high hazard process risks are as follows:

Aircraft hangars	Foam rubber and foam rubber goods manufacturers and warehouses
Celluloid manufacturers and celluloid goods manufacturers	LPG bulk storage
Fire lighter manufacturers	Paint, colour and varnish works
Fireworks manufacturers	Resin, lamp black and turpentine manufacturers
Floor cloth and linoleum manufacturers	Rubber substitute manufacturers
Foam plastics and foam plastics goods manufacturers and warehouses	Tar distillers
	Woodwool manufacturers

High piled storage risks

Extra high hazard high piled storage risks are subdivided into four categories. Fires in materials belonging to categories II, III and IV produce exceptionally intense fires with a high rate of heat release. The four categories are:

- (a) **Category I.** Category I comprises ordinary combustible materials and non-combustible materials in combustible wrappings, excluding those items specified under Categories II, III and IV, stored in bulk, in pallets or on racking, to heights exceeding 4m.

Examples of Category I storage are as follows:

Carpets Clothing	Groceries (items, not packaged)
Electrical appliances	Metal goods (in cartons)
Fibreboard (high density Hardboard)	Textiles
Glassware and crockery (in cartons)	All forms of paper storage other than those specified under Categories II and III

(b) **Category II** Examples of Category II storage are as follows:

Aerosol packs with flammable contents	Linoleum products
Baled cork Baled waste paper	Palletized whisky stocks Plastics (non-foamed) other than celluloid
Cartons and carton flats Cartons containing alcohols in cans or bottles Cartons of canned lacquers which dry by solvent evaporation Chipboard	Rolled pulp and paper (horizontal storage) Rolled asphalt paper (horizontal storage)
Fibreboard (low density soft board)	Veneer sheets Wood patterns Wooden furniture

(c) **Category III** Examples of Category III storage are as follows:

Bitumen coated or wax coated paper	Rolled asphalt paper (vertical storage) Rubber goods
Celluloid	Ventilated wood stacks
Esparto (loose)	Waxed or asphalt coated paper and containers in cartons
Flammable liquids in combustible containers Foamed plastics and foamed rubber products (with or without cartons) other than those specified in Category IV	Woodwool Wooden pallets and wooden flats (idle)
Rolled pulp and paper (vertical storage)	All materials having wrappings or preformed containers of foamed plastics

(d) **Category IV** Examples of Category IV storage are as follows:

Rolls of sheet foamed plastics or foamed rubber	Off-cuts and random pieces of foamed plastics or foamed rubber
--	---

NE1.2 FIRE MAINS AND WATER SUPPLY SERVICES

- (ii) remote from the building if they are at the boundary of the allotment, within sight of the main entrance to the building, adjacent to the principal vehicular access to the allotment and located not less than 10 m from the external wall of any building; or
 - (iii) in any other suitable position.
- (c) A permanent fade and water resistant plan, equal to photo-engraved anodized aluminum, must be displayed in a prominent position within the cabinet, showing the following information:
- (i) the layout of the building and adjacent streets;
 - (ii) the layout of the fire hydrant system reticulation, with supply authority street mains and size, location of street and allotment hydrants, fire hose reels, booster connections, street and allotment isolating and non-return valves, pumps and tanks;
- (iii) the operational discharge pressure and pressure at zero flow of any pump installed in the system;
 - (iv) the capacity of any tank connected to the system;
 - (v) the height of the highest hydrant outlet above the lowest booster inlet connection; and
 - (v) the year of installation of the system.
- (d) Suitable provision must be made for the drainage of water from within a booster or charged dry riser main system cabinet.

FIRE SPRINKLER SYSTEMS

1. Scope

This specification sets out requirements for the design and installation of *automatic fire sprinkler systems*.

2. Adoption of NZS 4541

An *automatic fire sprinkler system* and associated water supply must comply with NZS 4541 subject to this Specification. For further details of water supply requirements see Specification NE1.2.

3. Interpretation

A reference to FRR in NZS 4541 means FRL as defined in this code.

4. Definition of a sprinklered building

Notwithstanding NZS 4541, a building or a part of a building is deemed to be sprinklered if-

- (a) in the case of a whole building, the building complies with Section NC of this Code and is sprinklered throughout; or
- (b) in the case of a part of a building-

- (i) the part is sprinklered throughout and fire-separated from the unsprinklered part in accordance with Part NC2; and
- (ii) any opening in the fire separating construction between the sprinklered and unsprinklered parts is protected in accordance with Part NC3.

5. Exceptions

Where a building or part of a building is required to be sprinklered throughout, the exceptions nominated in clause 207 of NZS 4541 apply, except that a fire door in accordance with Part NC3 must be used for protection of openings.

6. Sprinkler valve enclosures

Sprinkler alarm valves must be located in a secure enclosure or room of adequate size, and where the valves are located within a building, the enclosure and *required* access to it must be suitable for the Fire Service.

7. Connection to evacuation alarm

The *sprinkler system* must be appropriately connected to any evacuation alarm system in the building to initiate the alarm in the event of activation of any sprinkler head.

FIRE DETECTION AND ALARM SYSTEMS

1. Scope

This Specification describes the installation and operation of automatic fire detection and alarm systems, and manually operated evacuation alarm systems. The automatic systems may also be used to operate a smoke control system within a building.

2. Automatic systems

An automatic fire detection and alarm system must comply with NZS 4512 subject to this Specification.

2.1 Purpose

The purpose of a fire detection and alarm system is to-

- (a) warn the occupants of any fire within the building;
- (b) alert the local Fire Service; and
- (c) activate any installed automatic smoke control system; and
- (d) provide for manual operation as an evacuation system.

2.2 Connection to extinguishing systems

Systems designed to NZS 4512 for the actuation of any fire extinguishing system must operate on a dual circuit to permit automatic operation of an evacuation alarm.

2.3 Location of smoke detectors

Smoke detectors must be-

- (a) wherever possible, surface mounted and external to air-conditioning and ventilation ducts, unless a point sampling system with maximum sensitivity level of 0.5% smoke obscuration is used;
- (b) located at natural collection points for hot smoke having regard to the ceiling geometry and its effects on the migratory path;
- (c) situated no closer than 3 m from smoke doors or fire doors; and
- (d) of the photo-electric type if installed within ducts or atmospheres contaminated with sub-micron dust and other particles likely to set off an ionization type detector.

2.4 Threshold levels

- (a) Sampling systems must comply with AS 1670, with response times and alarm thresholds maintained at

minimum levels and no alarm delay permitted on the highest alarm threshold.

- (b) The setting of alarm threshold levels for addressable detectors used within intelligent systems must not exceed the sensitivity levels nominated in-
 - (i) AS 1668.1; and
 - (ii) NZS 2139.

3. Manually operated evacuation fire alarm systems

- (a) Required manually operated evacuation alarm systems must comply with NZS 4581 for installation, operation and maintenance. The three systems considered are -

- Type A - Simple mechanical means;
- Type B - Simple electrical system, not monitored; and
- Type C - Electrical systems continuously monitored by connection to the fire service station.

- (b) When Type B systems are installed, the following warning notice must be clearly marked near each manual call point -

**NOT CONNECTED TO A FIRE SERVICE
IN CASE OF FIRE PHONE -----**

showing the telephone number of the fire authority in the locality.

Type B systems may be substituted with a self-contained battery operated system, provided care is taken to ensure that the battery has sufficient charge available at all times.

- (c) Location

Manual call points must be located not more than -

- (i) for Class 3 buildings, 20 m from the doorway of any sole-occupancy unit;
- (ii) for Class 5, 6, 7, 8 and 9b buildings, 20 m travel distance from any point on the floor; and
- (iii) for Class 9a buildings -
 - 12 m from any point of the floor of a ward area; or
 - 6 m from the entrance doorway of any room which may be occupied by a sleeping, sedated or dependant patient.

FIRE EMERGENCY CONTROL CENTRES

1. Scope

This Specification describes the construction and contents of *required* fire-control centres or rooms.

2. Purpose and content

A fire-control centre or room must-

- (a) provide an area from which fire fighting operations or other emergency procedures can be directed or controlled;
- (b) contain controls, panels, telephones, furniture, equipment and the like associated with the *required* fire services in the building; and
- (c) not be used for any purpose other than the control of-
 - (i) fire fighting activities; and
 - (ii) other measures concerning the safety or security of the building occupants.

3. Location of fire-control centre or room

A fire-control centre or room must be so located in a building that egress from any part of its floor, to a public road or *open space*, does not involve changes in level which in aggregate exceed 300 mm.

4. Construction

A fire-control centre in a building more than 50 m in *effective height* must be in a separate room where-

- (a) the enclosing construction is of concrete, masonry or the like, sufficiently impact resistant to withstand the impact of any likely falling debris, and with a FRL of not less than 120/120/120;
- (b) any material used as a finish, surface, lining or the like within the room complies with the requirements for *fire-isolated stairways* in Specification NC1.6.
- (c) services, pipes, ducts and the like that are not directly required for the proper functioning of the fire-control room do not pass through it; and
- (d) openings in the walls, floors or ceiling which separate the room from the interior of the building are confined to necessary doorways, ventilation and other openings for services, necessary for the proper functioning of the facility.

5. Protection of openings

Openings permitted by Clause 4 must be protected as follows:

- (a) Openings for *windows*, doorways, ventilation, service pipes, conduits and the like, in an *external wall* of the building that faces a public road or *open space*, must be protected in accordance with Part NC3 as applicable.
- (b) Openings in the floors, ceilings and *internal walls* enclosing a fire-control room must, except for doorways, be protected in accordance with Part NC3, as appropriate.
- (c) A door opening in the *internal walls* enclosing a fire-control room, must be fitted with a *self closing 120/120/30 smoke sealed fire door*.
- (d) Openings associated with natural or mechanical ventilation must-
 - (i) not be made in any ceiling or floor immediately above or below the fire-control room; and
 - (ii) be protected by a 120/120/- fire damper if the opening is for a duct through a wall *required* to have a FRL, other than an *external wall*.

6. Exit doors

- (a) *Required* doors to a fire-control room must open into the room, be lockable and located so that persons using escape routes from the building will not obstruct or hinder access to the room.
- (b) The fire-control room must be accessible via two paths of travel-
 - (i) one from the front entrance of the building; and
 - (ii) one direct from a public place or *fire-isolated passageway* which leads to a public place and has a FRL of not less than 120/120/120.

7. Size and contents

- (a) A fire-control room must contain not less than-
 - (i) a Fire Indicator Panel and necessary control switches and visual status-indication for all *required* fire pumps, smoke control fans and other *required* fire safety equipment installed in the building;
 - (ii) a telephone directly connected to an external telephone exchange;

- (iii) a blackboard or whiteboard not less than 1200 mm wide x 1000 mm high;
 - (iv) a pin up board not less than 1200 mm wide x 1000 mm high; and
 - (v) a raked plan layout table of size not less than the plans to be laid out upon the table, and plans of the structural, architectural, electrical, mechanical, lift and fire service details which may be stored beneath the plan layout table or within other suitable storage facility located in the room.
- (b) In addition, a fire-control room may contain-
- (i) master emergency control panels, lift annunciator panels, remote switching controls for gas or electrical supplies and emergency generator backup; and
 - (ii) building security, surveillance and management systems if they are completely segregated from all other systems.
- (c) A fire-control room must-
- (i) have a gross area of not less than 10 m² and the length of any internal side must be not less than 2.5 m;
 - (ii) if only the minimum prescribed equipment is installed- have a net floor area of not less than 8 m² with a clear space of not less than 1.5 m² in front of the Fire Indicator Panel; and
 - (iii) if additional equipment is installed, have an additional area of not less than 2 m² net floor area for each additional facility and a clear space of not less than 1.5 m² in front of each additional control or indicator panel,

and the area required for any path of travel through the room to other areas must be provided in addition to the requirements of (ii) and (iii).

B. Ventilation and power supply

A fire-control room must be ventilated by-

- (a) natural ventilation from a window or doorway in an external wall of the building which opens directly into the fire-control room from a roadway or open space; or
- (b) a pressurising system that only serves the fire-control room, and-
 - (i) is installed in accordance with AS 1668.1 as though the room is a fire-isolated stairway;
 - (ii) is activated automatically by operation of the fire alarm or sprinkler system installed in

the building and manually by an over-riding control in the room;

- (iii) provides a flow of fresh air through the room of not less than 30 air changes per hour when the system is operating and any door to the room is open;
- (iv) has fans, motors and ductwork that form part of the system but not contained within the fire-control room protected by enclosing construction with a FRL of not less than 120/120/120; and
- (v) has any electrical supply to the fire-control room or equipment necessary for its operation connected to the supply side of the main disconnection switch for the building and electrical service cables of copper-sheathed mineral-insulated cable with copper conductors,

and no openable window or other openable device other than necessary doorways, pressure controlled relief louvres and windows openable by a key, must be provided in the fire-control room.

9. Sign

The external face of the door to the fire-control room must have a sign with the words-

Fire Control Room

in letters not less than 50 mm high and colour which contrasts with that of the background.

10. Lighting

Emergency lighting in accordance with Part NE4 must be provided in a fire-control room, except that an illumination level of not less than 400 Lux must be maintained at the surface of the plan table.

11. Equipment not permitted within a fire-control centre or room

An internal combustion engine, pumps, sprinkler control valves, pipes and ancillary fittings must not be located in a fire-control centre or room, but may be located in rooms accessed through the fire-control centre or room.

12. Ambient Sound Level

The ambient sound level within the fire-control centre or room measured when all fire safety equipment is operating in the manner in which it operates in an emergency, must not exceed 65 dB(A), when determined in accordance with AS 2107.

AIR HANDLING SYSTEMS IN BUILDINGS

1. Scope

This Specification outlines the performance and operation of mechanical ventilation and airconditioning systems as they relate to smoke control in buildings.

2. Commonly Used Systems

The following commonly used systems may be installed:

- (a) small stand-alone or *window* units without ducting;
- (b) central chilled water systems with fan coil units located in each *storey* without any ducting;
- (c) central chilled water systems with separate air handling plants in each *storey* or *fire compartment* and associated independent ducting for the *storey* or *fire compartment*;
- (d) individual packaged plants and associated ducting for each *storey*; or
- (e) central plant where all the conditioning is done and with the ducting system connecting several *fire compartments* or *storeys*.

3. Action on Detection of Smoke Fire or Flame

In the case of small units the power supply to the units must be switched off manually. With all other systems immediately on activation of any of the detection units -

- (a) the total system for the whole building must shut down;
- (b) any *required exit* pressurisation system must operate; and
- (c) any *required smoke exhaust system* or *smoke-and-heat vent* must operate.

4. Compliance

The action required under 3(a), (b) or (c) must be *automatic* and be activated by :

- (a) smoke detectors located in each *storey* or *fire compartment* in accordance with Specification NE1.8 and with ducted systems, located just upstream of the supply fan as well as in the main return air duct; or
- (b) by any other suitable fire alarm system including a *sprinkler system*, installed within the building.

SMOKE EXHAUST SYSTEMS

1. Scope

This Specification describes the performance and method of operation of smoke exhaust systems in buildings which are designed to-

- (a) remove smoke from within the building using ducted or roof mounted exhaust fans; or
- (b) in a shopping centre complex or mall, remove smoke from within pedestrian malls to maintain for as long as possible a tenable escape path for the occupants.

2. Fan capacity

Fan systems must have an exhaust capacity in accordance with the height of the building as specified in Figure 2.

3. Compartmentation at ceiling level

The storey or room at ceiling level-

- (a) must be divided into compartments not more than 1500 m² in area by smoke curtains in accordance with AS 2665; or
- (b) in a shopping centre complex or mall, must have-
 - (i) smoke curtains or, toughened or wired glass or non-combustible bulkheads, which extend not less than 1 m beneath an imperforate ceiling; or
 - (ii) ceiling coffers not less than 500 mm deep, each containing a smoke exhaust fan,

across the full width of the mall to divide it into lengths of not more than 40 m.

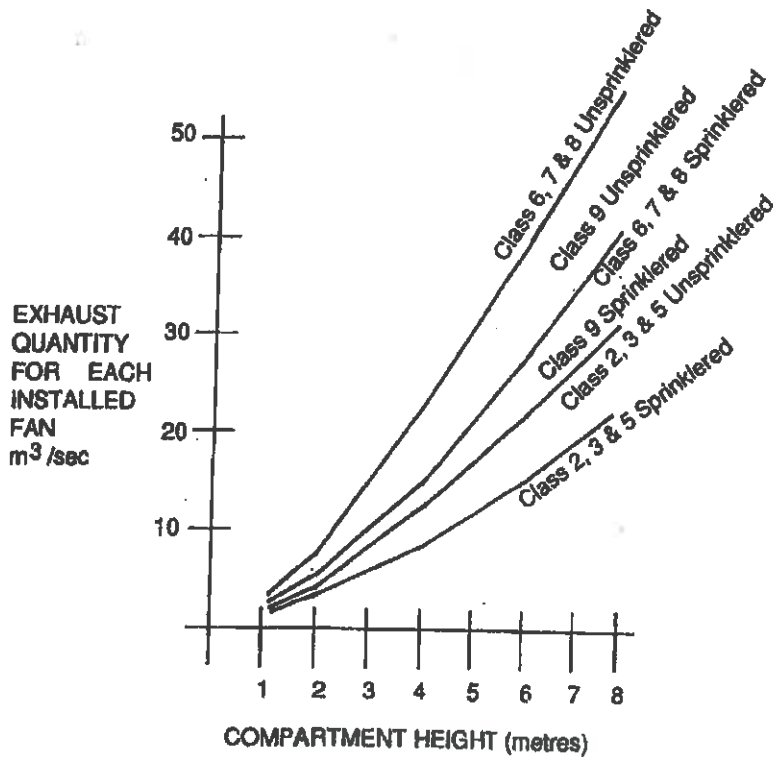

FIGURE 2 EXHAUST CAPACITY OF FANS

4. Location of fans and discharge

Exhaust fans must be located so as not to cause undue turbulence, and-

- (a) in a shopping centre complex or mall-
 - (i) be spaced no more than 40 m apart and not more than 20 m from the end of the mall;
 - (ii) not be at a mall intersection unless there is an open area where the ceiling is raised not less than 2 m above the ceiling in the mall; and
 - (iii) be located at natural collection points for the hot smoky gases within each smoke compartment having regard to the ceiling geometry and its effects on the migratory path of the smoke;
- (b) in other buildings be located so that each fan must serve not more than one 1500 m² roof compartment; and
- (c) discharge directly to the outside and in a manner that will not spread fire or smoke to adjacent fire compartments or buildings.

- (i) smoke detectors spaced not more than 30 m apart and 15 m from any curtain, bulkhead or wall and with not less than one detector for each 500 m² of floor area; or

- (ii) rate of rise heat detectors spaced not more than 15 m apart and 7.5m from any curtain, bulkhead or wall and with not less than one detector for each 250 m² of floor area, and not less than 2 detectors located on opposite sides of each fan inlet; or

- (d) in a shopping centre complex or mall-
 - (i) optical smoke detectors in each smoke compartment with at least one detector for each 150 m² of floor area, arranged in at least 2 groups so that on activation of an alarm group in the respective smoke compartment full exhaust is initiated, and on activation of a second group and following a 30 second check period an alarm is transmitted to the fire service station; and
 - (ii) a manual break-glass alarm at each exit from a shop with a floor area of more than 1000 m² arranged to activate the exhaust system and transmit an alarm to the Fire Brigade.

5. Make-up air

Low level fresh air inlet openings or doors must be sized to provide adequate low velocity fresh air make up to satisfy the exhaust performance of the installed smoke exhaust fans, care being exercised in the number and location of such openings and their disturbance of the smoke layer due to turbulence created by the incoming air.

6. Operation of fans

All smoke exhaust fans must start sequentially and be activated by the operation in the area served by the fan of-

- (a) a sprinkler system;
- (b) a fire detection and alarm system which complies with Specification NE1.8;
- (c) a detector system comprising-

7. Protection of wiring

Power supply wiring for roof-mounted exhaust fans must be MIMS (copper) cable or otherwise suitably fire-protected where it passes through other storeys and might be affected by fire remote from the floor served by the plant.

8. Resistance to high-temperatures

If not adequately shielded from the airflow-

- (a) all parts of exhaust fans and other equipment required to operate in a smoke laden environment; and
- (b) parts of the building required to be smoke-resisting,

must be capable of withstanding a temperature of 200° C for a period of not less than 1 hour.

PERFORMANCE REQUIREMENTS

OBJECTIVES

A building must be designed and constructed to meet the following objectives -

NFP1 Damp and Weatherproofing

Suitable damp and weatherproofing must be provided where necessary to prevent-

- (a) moisture or damp affecting the stability of the building;
- (b) the creation of any unhealthy or dangerous condition; or
- (c) causing damage to adjoining property.

NFP2 Cooking and Sanitary Facilities

Adequate toilet and washing facilities must be provided for the occupants of a building, having regard to its use and size. In residential buildings other than those meant for transient occupants suitable facilities must also be available for the preparation and cooking of food, the cleaning of utensils and the laundering of clothes.

NFP3 Room Sizes

The floor area, plan dimensions and ceiling heights of rooms and other spaces within a building must be adequate for their use or purpose.

NFP4 Light and Ventilation

The standard of light and ventilation within a building must be adequate for the occupants, having regard to the use or purpose of the building.

NFP5 Water Supply Plumbing

An appropriate safe and hygienic system of plumbing for the supply of water for domestic needs must be provided.

NFP6 Sanitary Plumbing

An appropriate system of drainage for the hygienic waterborne conveyance of waste water must be provided.

NFP7 Roof Drainage

Where a roof drainage system is provided, it must give reasonable protection against the overflow of rainwater into the building.

NFP9 Site Drainage

Unhealthy ponding of water in the allotment must not be allowed and the erection of the building or any alteration to it must not adversely affect the drainage of other allotments or of any public land.

REQUIRED PERFORMANCE

NFP1.1 Damp and weatherproofing

Water and damp conditions must not be allowed to -

- (a) affect the stability of buildings;
- (b) create ill health or discomfort for the occupants;
- (c) damage or deface buildings as a result of moisture present at the completion of construction; or
- (d) cause damage to adjacent property.

NFP2.1 Cooking and sanitary facilities

Any cooking facility provided must not spread smoke which may affect health or create a nuisance to the occupants or neighbours. Washing and clothes laundering facilities provided in residential buildings must be consistent with the size and occupancy of the building. The standard of toilet and washing facilities provided must in any building not create a nuisance or lead to ill health to the occupants or neighbours. These facilities must be located conveniently and the number of units provided must be consistent with the size and class of occupancy. Smoke extraction units from kitchens and other process operations in Class 6, 8 or 9 buildings must ensure that the progressive build-up of soot, grease and the like does not lead to a fire or unhealthy conditions.

NFP3.1 Room sizes

The size and disposition of rooms in a building must be consistent with the requirements of health and hygiene.

NFP4.1 Light and ventilation

Where airhandling systems are provided in a building there must be adequate provision for natural ventilation to cater for any prolonged failure of the system.

NFP5.1 Water supply plumbing

Plumbing for potable water supply must use materials which do not react with the water and thereby make it unsuitable. Suitable precautions must be taken to ensure that unsafe or unhygienic materials have no chance of entering the

supply system. The installation of hot water systems must not impair the safety of the users. All concealed and difficult-to-access plumbing work must be suitably protected so that there is no likelihood of damage and leakage. The plumbing must take into account the current and anticipated needs of the user and allow for the simultaneous use of the connected system by others.

NFP6.1 Sanitary plumbing and drainage

Sanitary plumbing must be laid to self-cleansing grades consistent with their discharge loading, unless other suitable arrangements are made to ensure that the system is kept free of the accretion of sewage and other waste matter. The size of drains and the layout of their connections must reasonably ensure the current and anticipated needs of the users. The connections to sanitary installations must ensure that foul gases are not allowed to produce unhygienic conditions nor create any nuisance to anyone and are suitably vented.

NFP7.1 Roof drainage

The roof drainage system must be capable of handling peak intensities of rainfall as follows:

- (a) Eaves gutters and downpipes - a 20 year return intensity.
- (b) Internal box gutters, valley gutters and downpipes - a 100 year return intensity.

Any known local variation in rain fall intensity must be taken into account. Sufficient allowance must be made for the possibility of overflow into the building due to ripples and turbulence in the flowing water during cyclonic winds.

NFP9.1 Site drainage

The immediate site around the building must have suitable drainage so that no ponding results. Viable water must not be allowed to remain under or around for more than 1 hour after 10 minutes of maximum rainfall resulting from a storm with a return period of 5 years. Flood waters or waves resulting from a storm or cyclone with a return period of 30 years must not be allowed to enter a building.

**NATIONAL
BUILDING
CODE
1990**

PUBLIC BUILDINGS AND GROUP DWELLINGS (CLASS 2 TO 9)

SECTION NF

HEALTH AND AMENITY

**Performance Requirements
Deemed-to-Satisfy Provisions**

- NF1 Damp and Weatherproofing**
- NF2 Sanitary Facilities**
- NF3 Room Sizes**
- NF4 Light and Ventilation**
- NF5 Watersupply Plumbing**
- NF6 Sanitary Plumbing and Drainage**
- NF7 Roof Drainage**

CONTENTS

PERFORMANCE REQUIREMENTS

DEEMED-TO-SATISFY PROVISIONS

Part	Part
NF1 Damp and Weatherproofing	NF4.7 Ventilation borrowed from adjoining room
NF1.1 Site drainage	NF4.8 Restriction on position of WCs and urinals
NF1.2 Building on land subject to dampness	NF4.9 Airlocks
NF1.3 Drainage of land external to building	NF4.10 Sub-floor ventilation
NF1.4 Weatherproofing of roofs and walls	NF4.11 Public carparks
NF1.5 Pliable roof sarking	NF4.12 Uncovered space for Class 4 parts
NF1.6 Water proofing of wet areas in buildings	
NF1.7 Damp-proof courses	NF5 Watersupply Plumbing
NF1.8 Acceptable damp-proof courses	NF5.1 General requirements
NF1.9 Damp-proofing of floors on the ground	NF5.2 Means of compliance
	NF5.3 Pipes which are not easy to access
NF2 Sanitary Facilities	NF5.4 Access to domestic-type water heaters
NF2.1 Facilities in residential buildings other than Class 1 and 10	
NF2.2 Calculation of number of occupants and fixtures	NF6 Sanitary Plumbing and Drainage
NF2.3 Facilities in Class 3 to 9 buildings	NF6.1 General requirements
NF2.4 Facilities for people with disabilities	NF6.2 Means of compliance
NF2.5 Construction of sanitary compartments	NF6.3 Certain floors to be drained
NF2.6 Interpretation: Urinals and washbasins	NF6.4 Grease trap
	NF6.5 Toxic wastes
NF3 Room Sizes	NF6.6 Small treatment plants
NF3.1 Height of rooms	
NF3.2 Reduced height permissible	NF7 Roof Drainage
NF3.3 Ceiling fans	NF7.1 General requirements
NF3.4 Size of rooms	NF7.2 Means of compliance
NF4 Light and Ventilation	Specifications
NF4.1 Provision of natural light	Specification NF7.2
NF4.2 Methods and extent of natural lighting	Sizing of Gutters and Downpipes
NF4.3 Natural light borrowed from adjoining room	
NF4.4 Artificial lighting	
NF4.5 Ventilation of rooms	
NF4.6 Natural ventilation	

DEEMED-TO-SATISFY PROVISIONS

DAMP AND WEATHERPROOFING

NF1.1 Site drainage

The construction of a site drainage system and the position and manner of discharge of a stormwater drain must not-

- (a) result in the entry of water into any building or other allotment;
- (b) affect the stability of any building; or
- (c) create any unhealthy or dangerous condition within or around any building.

NF1.2 Building on land subject to dampness

One or more of the following measures must be carried out if it is warranted by the dampness of the building site:

- (a) The subsoil must be adequately drained.
- (b) The ground under the building must be regraded or filled and provided with outlets to prevent accumulation of water.
- (c) The surface of the ground under the building must be covered with a suitable damp-resisting material.

NF1.3 Drainage of land external to building

A suitable system of drainage must be provided if paving, excavation or any other work on an allotment will cause undue interference with the existing drainage of rainwater falling on the allotment whether the existing drainage is natural or otherwise.

NF1.4 Weatherproofing of roofs and walls

Roofs and external walls (including openings for windows doors and the like) must be constructed to prevent rain or dampness penetrating to the inner parts of a building, unless it is -

- (a) a Class 7, 8 or 10 building and in the particular case there is no necessity for compliance;
- (b) a garage, tool shed, *sanitary compartment*, or the like, forming part of a building used for other purposes; or
- (c) an open spectator stand or open deck carpark.

NF1.5 Pliable roof sarking

Pliable roof sarking-type material used under roof or wall coverings must comply and be fixed in accordance with-

- (a) AS 1736; or
- (b) AS 1903 and AS 1904.

NF1.6 Water proofing of wet areas in buildings

The following parts of a building must be impervious to water:

- (a) In any building - the floor surface or substrate in a shower enclosure, or within 1.5 m measured horizontally from a point vertically below the shower fitting, if there is no enclosure.
- (b) In a Class 3, 5, 6, 7, 8 or 9 building - the floor surface or substrate in a bathroom or shower room, slop sink compartment, laundry or *sanitary compartment* which is used in common by the occupants.
- (c) The wall surface or substrate-
 - (i) of a shower enclosure, or if the shower is not enclosed, within 1.5 m and exposed to a shower fitting, to a height of 1.8 m above the floor;
 - (ii) immediately adjacent or behind a bath, trough, basin, sink, or similar fixture, to a height of 300 mm above the fixture if it is within 75 mm of the wall.
- (d) The junction between the floor and wall if the wall and floor are *required* to be impervious to water.
- (e) The junction between the wall and fixture if the wall is *required* to be impervious to water.

NF1.7 Damp-proof courses

Except in a building that is exempt from weatherproofing under NF1.4, moisture from the ground must be prevented from reaching-

- (a) the lowest floor timbers and the walls above the lowest floor joists;
- (b) the walls above the damp-proof course; and
- (c) the underside of a suspended floor constructed of a material other than timber, and the supporting beams or girders.

NF1.8 Acceptable damp-proof courses

A damp-proof course must consist of-

- (a) a material that complies with AS 2904;
- (b) suitable termite shields placed on piers; or
- (c) other suitable material.

NF1 DAMP AND WEATHERPROOFING

NF1.9 Damp-proofing of floors on the ground

If a floor of a room is laid on the ground or on filling-

(a) moisture from the ground must be prevented from reaching the upper surface of the floor and adjacent walls by-

(i) the insertion of a vapour barrier in accordance with AS 2870.1; or

(ii) other suitable means; and

(b) damp-proofing need not be provided if the building is exempt from weatherproofing under NF1.4.

SANITARY AND OTHER FACILITIES

NF2.1 Facilities for residential buildings other than Class 1 and 10

Sanitary and other facilities for Class 2 and 3 buildings, and Class 4 parts of buildings, must be provided in accordance with Table NF2.1.

**TABLE NF2.1
PROVISION OF SANITARY AND OTHER FACILITIES**

**CLASS OF MINIMUM FACILITIES REQUIRED
BUILDING**

Class 2 Within each sole-occupancy unit-

- (a) a kitchen sink and facilities for the preparation and cooking of food;
- (b) a shower; and
- (c) a closet pan and facilities for washing hands.

For each building-

- (a) a separate laundry for each 4 sole-occupancy units, or part without its own clothes washing facilities, comprising at least one washtub and space for a washing machine;
- (b) clothes drying facilities comprising-
 - (i) lines or clothes hoists with not less than 7.5m of line per sole-occupancy unit; or
 - (ii) one heat-operated drying cabinet or appliance for each 4 sole-occupancy units, or part, without its own drying facilities.

Facilities for employees-

If the building contains more than 32 sole-occupancy units, or if a group of Class 2 buildings on the one allotment contains in total, more than 32 sole-occupancy units -

a closet pan and washbasin in a compartment or room at or near ground level and accessible to employees without having to enter a sole-occupancy unit

**TABLE NF2.1 Continued
CLASS OF MINIMUM FACILITIES REQUIRED
BUILDING**

Class 3 Facilities for residents-

For each 10 residents for whom private facilities are not provided-

- (a) a shower; and
- (b) a closet pan and washbasin, except that if one urinal is provided for each 25 males up to 50 and one additional urinal for each additional 50 males or part thereof, one closet pan for each 12 males may be provided.

If these facilities are situated outside the building, they should be conveniently accessible.

Class 4 For each sole-occupancy unit -

- (a) a kitchen sink and facilities for the preparation and cooking of food;
- (b) a shower;
- (c) a closet pan and washbasin;
- (d) clothes washing facilities, comprising a washtub and space in the same room for a washing machine; and
- (e) a clothes line or hoist, or space for a heat-operated drying cabinet or similar appliance for the exclusive use of the occupants.

NF2.2 Calculation of number of occupants and fixtures

- (a) The number of persons accommodated must be calculated according to Table ND1.13 if it cannot be more accurately determined by other means.
- (b) Unless the premises are predominantly used by one sex or numbers of male and female users are known, sanitary facilities must be provided equally for both sexes.

In addition where the nature of employment of an employee is such that a shower is highly desirable at the end of the work (eg. cooks and kitchen hands), showers must be provided for each 10 such male or female employee in any one shift.

NF2 SANITARY AND OTHER FACILITIES

NF2.3 Facilities in Class 3 to 9 Buildings

Sanitary facilities must be provided in Class 3, 5, 6, 7, 8 and 9 buildings in accordance with Table NF2.3.

**TABLE NF2.3
SANITARY AND OTHER FACILITIES**

Class of Building	User	Max Number Served by-								
		Closet Fixture (s)			Urinals (s)			Washbasin (s)		
		1 Up to	2 Up to	Each Extra	1 Up to	2 Up to	Each Extra	1 Up to	2 Up to	Each Extra
3,5,6 and 9 other than schools	Employees									
	Males	20	40	20	25	50	50	60	120	60
	Females	15	30	15	-	-	-	60	120	60
7 and 8	Employees									
	Males	20	40	20	25	50	50	30	60	30
	Females	15	30	15	-	-	-	30	60	30
6 - Department stores, shopping centres and, individual shops in excess of 900 m ² total floor area	Patrons-									
	Males	500	2400	1200	600	1200	1200	1000	4000	2000
	Females	300	600	1200	-	-	-	1000	4000	2000
6- Restaurants cafes, bars, public halls, function rooms and 9a - out patients	Patrons-									
	Males	50	200	250	50	200	100	50	200	250
	Females	30	70	80	-	-	-	50	200	250
9a-Health-care buildings (Other than for out patients)	Resident Patients-									
	Males	-	16	8	-	-	-	16	32	16
	Females	-	16	8	-	-	-	16	32	16
- Other facilities - One shower for each 8, or part, patients or inmates.										
9b - Schools not being early child-hood centres	Staff and employees-									
	Males	20	40	20	25	50	50	30	60	30
	Females	15	30	15	-	-	-	30	60	30
	Students-									
	Males	30	70	70	30	70	40	60	140	140
	Females	20	40	30	-	-	-	60	140	140
- Other facilities - A minimum of one shower each for male and female students										
9b - Early childhood centres	Children	-	30	15	-	-	-	-	30	15
- Other facilities - One shower must be provided.										

**TABLE NF2.3 Continued
SANITARY AND OTHER FACILITIES**

Class of Building	User	Max Number Served by-									
		Closet Fixture (s)			Urinal (s)			Washbasin (s)			
		1 Up to	2 Up to	Each Extra	1 Up to	2 Up to	Each Extra	1 Up to	2 Up to	Each Extra	
9b - Sporting venues, theatres, cinemas, art galleries or the like and churches, chapels or the like	Participants at sporting venues, theatres or the like										
	Males	20	40	20	10	-	10	20	40	20	
	Females	15	30	15	-	-	-	20	40	20	
	- Other facilities: One shower for each 10 or part, participants.										
	Spectators or patrons										
	Males	250	500	500	100	200	100	250	500	500	
Females	75	250	250	-	-	-	250	500	500		

NF2.4 Facilities for people with disabilities

Sanitary facilities must be provided in accordance with Table NF2.4 in every Class 3, 5, 6, 7 and 9 building that is required by Part ND3 to be accessible to people with disabilities.

**TABLE NF2.4
SANITARY FACILITIES FOR PEOPLE WITH DISABILITIES**

CLASS OF BUILDING	MINIMUM FACILITY FOR USE BY PEOPLE WITH DISABILITIES
Class 3 - In every sole-occupancy unit to which access for people with disabilities is required -	
(a)	one closet pan and washbasin; and
(b)	one shower .
Class 5, 6, 7 and 9 buildings with floor area more than 1000 m² and Class 3 if accommodation is other than in sole-occupancy units , or other parts of the building are required to be accessible-	
NUMBER OF PERSONS FOR WHOM TOTAL FACILITIES NORMALLY REQUIRED	MINIMUM NUMBER FOR USE BY PEOPLE WITH DISABILITIES
Closet pans plus urinals-	
1 - 100	(a) one unisex facility; or (b) one closet pan and washbasin for each sex.
101 - 200	(a) 2 unisex facilities; or (b) one closet pan and washbasin for each sex and one unisex facility.

TABLE NF2.4 Continued

SANITARY FACILITIES FOR PEOPLE WITH DISABILITIES

- | | | |
|---------------------|-----|--|
| More than 200 | (a) | 2 unisex facilities or one closet pan and washbasin for each sex and one unisex facility; and |
| | (b) | one additional unisex facility or one closet pan and washbasin for each sex for each additional 100 persons. |

In all cases, facilities for females must include adequate means for the disposal of sanitary towels.

Baths or showers one shower or shower-bath for each 10 or part thereof normally required, but not less than one for use by both sexes.

NF2.5 Construction of sanitary compartments

- (a) Partitions - Other than in any *early childhood centre, sanitary compartments* must have doors and partitions must separate adjacent compartments and extend-
- (i) from floor level to the ceiling in the case of a unisex facility; or
 - (ii) to a height of not less than 1500 mm above the floor if *primary school* children are the principal users, or 1800 mm above the floor in all other cases.
- (b) Facilities for people with disabilities - The construction and layout of *sanitary compartments* for use by people with disabilities must comply with AS 1428.1, or NZS 4121 and NZS 4122.

NF2.6 Interpretation: Urinals and washbasins

- (a) A urinal may be either-
- (i) an individual stall or wall hung urinal;
 - (ii) each 600 mm length of a continuous urinal trough; or
 - (iii) a closet pan used in place of a urinal.
- (b) A washbasin may be either-
- (i) an individual basin; or
 - (ii) a part of a hand wash trough served by a single water tap.

ROOM SIZES

NF3.1 Height of rooms

Minimum heights below the ceiling and any framing excluding minor projections such as cornices, are:

- (a) Class 2, or 3 buildings, or Class 4 parts-
 - (i) *habitable* room - 2.4 m;
 - (ii) laundry or the like - 2.1 m; and
 - (iii) corridor or passageway - 2.1 m.
- (b) Class 5, 6, 7 and 8 buildings-
 - (i) areas other than in (ii) - 2.4 m; and
 - (ii) corridor, passageway, or the like - 2.1 m.
- (c) Class 9a building -
 - (i) *ward area* - 2.4 m;
 - (ii) operating theatre or delivery room - 3.0 m; and
 - (iii) treatment room, clinic, waiting room, passageway, corridor, or the like - 2.4 m.
- (d) Class 9b buildings -
 - (i) *school* classroom or other *assembly building* or part that accommodates not more than 100 persons - 2.4 m; and
 - (ii) theatre, public hall or other *assembly building* or part that accommodates more than 100 persons - 3.0 m.
- (e) Ancillary and other spaces -
 - (i) bathroom, shower room, water closet, toilet room, airlock, tea preparation room, pantry, store room, garage, carparking area, or the like, in any class of building - 2.1 m.

NF3.2 Reduced height permissible

These heights may be reduced if the reduction does not unduly interfere with the proper functioning of the room in-

- (a) attic rooms
- (b) rooms with a sloping ceiling or projection below ceiling line; or
- (c) other rooms or spaces.

NF3.3 Ceiling fans

Ceiling fans and other such appliances must be at a minimum vertical clearance of 2.1 m.

NF3.4 Size of rooms

In Class 2, 3 or Class 4 parts *habitable rooms* excluding kitchens must have a minimum floor area of 6 m². The size of a toilet must be not less than 1.5 m x 0.75 m and of a shower cubicle, 0.74 m x 0.74 m.

LIGHT AND VENTILATION

NF4.1 Provision of Natural Light

Natural lighting must be provided in:

- (a) Class 2 buildings and Class 4 parts - to all *habitable rooms*.
- (b) Class 3 buildings - to all bedrooms and dormitories.
- (c) Class 9a buildings - to all rooms used for sleeping purposes.
- (d) Class 9b buildings - to all general purpose classrooms in primary or secondary *schools* and all playrooms or the like for the use of children in an *early childhood centre*.

NF4.2 Methods and extent of natural lighting

Direct natural lighting must be provided by *windows* that-

- (a) have an aggregate light transmitting area measured excluding framing members, glazing bars or other obstructions of not less than 10% of the *floor area* of the room;
 - (b) face-
 - (i) a court or other space open to the sky; or
 - (ii) an open verandah, open carport, or the like;
- (c) are not less than a horizontal distance from any adjoining allotment, or a wall of the same building or another building on the allotment that they face, that is the greater of-
 - (i) in a Class 2, 3 or 9 building or a Class 4 part - 1 m;
 - (ii) in a *ward area* or other room used for sleeping purposes in a Class 9a building - 3 m; and
 - (iii) 50% of the square root of the height of the wall in which the *window* is located, measured in metres from its sill.

NF4.3 Natural light borrowed from adjoining room

Natural lighting to a room in a Class 2 or 4 building, or in a *sole-occupancy unit* of a Class 3 building may come through a glazed panel or opening from an adjoining room (including an enclosed verandah) if-

- (a) in a Class 2 or 3 building or Class 4 part, both rooms are within the same *sole-occupancy unit* or the enclosed verandah is on common property;

- (b) the glazed panel or opening has an area of not less than 10% of the *floor area* of the room to which it provides light; and
- (c) the adjoining room has *windows* with an aggregate light transmitting area of not less than 10% of the combined *floor areas* of both rooms.

The areas specified in (b) and (c) may be reduced as appropriate if direct natural light is provided from another source.

NF4.4 Artificial lighting

Artificial lighting must be provided-

- (a) in *required* stairways and ramps by means of separate electrical wiring circuits from the main switchboard for the exclusive use of the stairway or ramp; and
- (b) if natural lighting of a standard equivalent to that *required* by NF4.2 is not available and the periods of occupation, or use of the room or space will create undue hazard to occupants seeking egress in an emergency, in -
 - (i) Class 4 parts - to *sanitary compartments*, bathrooms, shower rooms, airlocks and laundries;
 - (ii) Class 2 buildings - to *sanitary compartments*, bathrooms, shower rooms, airlocks, laundries, common stairways and other spaces used in common by the occupants of the building; and
 - (iii) Class 3, 5, 6, 7, 8 and 9 buildings - to all rooms that are frequently occupied and all corridors, lobbies, internal stairways, other circulation spaces and paths of egress.

NF4.5 Ventilation of rooms

- (a) A *habitable room*, office, shop, factory, workroom, *sanitary compartment*, bathroom, shower room, laundry and any other room occupied by a person for any purpose must have adequate flow-through or cross-ventilation and air quality, including sufficient air-changes and fresh air quantities.
- (b) Provision of either-
 - (i) natural ventilation complying with NF4.6; or
 - (ii) a mechanical ventilation or air conditioning system complying with Table 3 of AS 1668.2, with provision for natural ventilation to NF4.6 for use in case of a lengthy failure of the mechanical system,

satisfies (a).

Where the *required* ventilation relies on mechanical or air-conditioning systems, *habitable rooms*, offices, shops, factories, workrooms or commercial laundries must have alternate natural ventilation for use in case of a lengthy failure of the mechanical system. The extent of natural ventilation available must be not less than 25% of that *required* under NF4.6. Otherwise the mechanical system must have a complete stand-by system including for power generation.

NF4.6 Natural ventilation

Required natural ventilation must be provided by permanent windows, openings, doors or other devices -

- (a) with an aggregate opening or openable size not less than 10% of the *floor area* of the room *required* to be ventilated; and
- (b) which open to-
 - (i) a court, or space open to the sky; or
 - (ii) an open verandah, open carport, or the like.

NF4.7 Ventilation borrowed from adjoining room

Natural ventilation to a room may come through a *window*, opening, ventilating door or other device from an adjoining room (including an enclosed verandah) if both rooms are within the same *sole-occupancy unit* or the enclosed verandah is common property, and-

- (a) in a Class 2 building, a *sole-occupancy unit* of a Class 3 building or a Class 4 part of a building-
 - (i) the room to be ventilated is not a *sanitary compartment*;
 - (ii) ventilation is not borrowed from one bedroom to another or between a bedroom and the kitchen;
 - (iii) the *window*, opening, door or other device has a ventilating area of not less than 10% of the *floor area* of the room to be ventilated; and
 - (iv) the adjoining room has a *window*, opening, door or other device with a ventilating area of not less than 10% of the combined *floor areas* of both rooms;
- (b) in a Class 5, 6, 7, 8 or 9 building-
 - (i) the *window*, opening, door or other device has a ventilating area of not less than 10% of the *floor area* of the room to be ventilated, measured not more than 3.6 m above the floor; and

- (ii) the adjoining room has a *window*, opening, door or other device with a ventilating area of not less than 10% of the combined *floor areas* of both rooms; and

- (c) the ventilating areas specified in (a) and (b) may be reduced as appropriate if direct natural ventilation is provided from another source.

NF4.8 Restriction on position of WCs and urinals

A room containing a closet pan or urinal must not open directly into-

- (a) a kitchen or pantry;
- (b) a public dining room or restaurant;
- (c) a dormitory in a Class 3 building;
- (d) a room used for public assembly; or
- (e) a workplace normally occupied by more than one person.

NF4.9 Airlocks

If a room containing a closet pan or urinal is prohibited under NF4.8 from opening directly to another room-

- (a) in a *sole-occupancy unit* in a Class 2 or 3 building or in a Class 4 part-
 - (i) access must be by an airlock, hallway or other room; or
 - (ii) the room containing the closet pan or urinal must be provided with an exhaust fan; and
- (b) in a Class 5, 6, 7, 8 or 9 building (which is not an *early childhood centre*, primary school or open spectator stand) -
 - (i) access must be by an airlock, hallway or other room with a *floor area* of not less than 1.1 m² and fitted with *self-closing doors* at all access doorways; or
 - (ii) the room containing the closet pan or urinal must be provided with mechanical exhaust ventilation and the doorway to the room adequately screened from view.

NF4.10 Sub-floor ventilation

- (a) Suitable provision must be made to prevent undue deterioration of the lowest floor of a building because of dampness, other conditions on the allotment or the design of the building.
- (b) The following would satisfy the requirements of (a)-

(i) where timber is used, the floor framing must be suspended with an absolute minimum of 250 mm and an average minimum of 400 mm clearance from the ground underneath to the floor and the immediate surrounds of the building. The average clearance must be determined as the average of the clearances at the corners of a 3 m square grid covering the building. Subfloor ventilation must be provided with ventilation openings totalling not less than 3% of the peripheral vertical area between the ground and the boundary of the floor. These openings are to be spaced uniformly and at not more than 1.8 m apart.

(ii) where other than timber is used:
subfloor ventilation must be provided if the floor is suspended;
an impervious cover provided over the ground surface beneath the building; or

the floor members suitably treated.

NF4.11 Public car parks

Every storey of a public car park must have-

- (a) a mechanical ventilation or air-conditioning system complying with AS 1668.2; or
- (b) a suitable system of permanent natural ventilation in accordance with NF4.6.

NF4.12 Uncovered space for Class 4 parts

Class 4 parts of buildings must have sole access to a space open to the sky of 20 m² minimum area. Of this at least 5 m² must be at the same level as the Class 4 part and the rest may be at either 3 m above or 3 m below.

WATERSUPPLY PLUMBING

NF5.1 General requirements

The plumbing work for water supply must ensure -

- (a) the appropriateness of the materials and products used;
- (b) the correct sizing of water services for the intended use;
- (c) the control of cross-connections and prevention of backflow;
- (d) adequate care in the installation of the services;
- (e) suitable provision of main and subsidiary storage as required;
- (f) adequate connections to sanitary services without endangering health and hygiene; and
- (g) the installation of hot water systems to provide safe and adequate service

NF5.2 Means of compliance

The requirements of NF5.1 are satisfied if all plumbing for watersupply is carried out to the relevant provisions of -

- (a) AS 3500 - Part 1 for cold water service; and
- (b) AS 3500 - Part 4 for hot water service.

NF5.3 Pipes which are not easy to access

Particular attention is drawn to the provisions in AS 3500 - Parts 1 and 4 which prohibit the installation of pipes and fittings of certain materials in locations which are concealed or difficult to access. These include pipes made of ABS, galvanised steel, polybutylene and UPVC. Pipes and fittings made of copper, copper alloy, stainless steel, ductile iron, cast iron and polyethylene when used in concealed or difficult to access locations must follow the special precautions specified in AS 3500 - Parts 1 and 4.

NF5.4 Access to domestic-type water heaters

- (a) A household water heater which is installed in a building must-
 - (i) be supported on construction sufficient to carry its full capacity weight and any possible wind or earthquake loads;
 - (ii) be positioned to enable adequate access for operation, maintenance and removal; and
 - (iii) provide suitably for any overflow, especially if installed in a concealed location.
- (b) AS 3500 - Part 4 is the relevant standard for the installation of a household water heater.

SANITARY PLUMBING AND DRAINAGE

NF6.1 General requirements

Sanitary plumbing and drainage must ensure -

- (a) the appropriateness of the products and materials used;
- (b) the correct sizing of drainage services for the intended use;
- (c) adequate care in the installation of the services including the provision of appropriate grades; and
- (d) that foul gases are not allowed to produce unhygienic conditions or any nuisance to anyone.

NF6.2 Means of compliance

The requirements of NF6.1 are satisfied if all sanitary plumbing and drainage works are carried out to the relevant provisions of AS 3500 - Part 2 - Sanitary plumbing and sanitary drainage.

NF6.3 Certain floors to be drained

In a Class 2, 3 or 4 Part building the floor of each bathroom and laundry in a *sole-occupancy unit* which is located at other than the lowest level must be graded to permit drainage to a floor waste gully.

NF6.4 Grease trap

Where the nature of the occupancy is such that the waste water contains grease, fats or oils to levels unacceptable to the Authority having jurisdiction, a suitable grease trap must be installed. The accumulated grease and oils must be removed at intervals sufficient to prevent their escape into the disposal system. After removal the grease and oils must be suitably disposed off.

NF6.5 Trade wastes

Any trade waste unacceptable to the Authority having jurisdiction must be pretreated before it enters the disposal system.

NF6.6 Small treatment plants

Where there is no public sewerage and treatment system available one of the following methods may be used for the treatment of sewage:

- (a) Packaged treatment plants.
- (b) Septic tanks.
- (c) Any other suitable method.

The details given in Annexure 2 to Specification DF2.1 may be used for the preliminary design of the main elements of a septic tank system if such a system is considered.

ROOF DRAINAGE**NF7.1 General requirements**

Gutters and downpipes where provided must have sufficient capacity to reasonably prevent the overflow of rain water into the building. The peak intensities of rainfall that the gutters and associated downpipes must be able to handle are as follows:

- (a) Eaves gutters -
a 20 year return intensity of 115 mm/hr
- (b) Box and valley gutters -
a 100 year return intensity of 150 mm/hr

- (c) Gutters and downpipes for temporary buildings must cater to a 5 year return intensity of rainfall of 85 mm/hr.

Eaves gutters other than for temporary buildings must have a designed free-board of 25 mm and box gutters, 35 mm.

NF7.2 Means of compliance

The requirements of NF7.1 are satisfied if the requirements of AS 2179 - Metal rainwater goods - Specification and AS 2180 - Metal rainwater goods - Selection and installation, are met. Specification NF7.2 covers some of these requirements.

SIZING OF GUTTERS AND DOWNPIPES

1 DESIGN CRITERIA

The design of a roof-drainage system is based on the following factors:

- Rainfall intensity and risk of flooding
- Catchment area of roof
- Gutter efficiency
- Spacing of downpipes.

1.1 Rainfall Intensity

In rainstorms long periods of steady rainfall are interspersed with peak intensities for short periods. The roof-drainage system must be capable of handling the peak intensities without flooding or overflow. Peak intensities for Fiji are as follows:

5 year return period	85 mm/hr
20 year return period	115 mm/hr
100 year return period	150 mm/hr

Any known local variations should be taken into account. The 5 year return intensity is used in the design of temporary structures of short life. The design of eaves gutters of permanent buildings must be based on the 20 year return intensity and of internal box gutters and valley gutters on the 100 year return intensity. A freeboard of 25 mm for eaves gutters and of 35 mm for internal box gutters and valley gutters are *required* to provide against overflow into buildings.

2 CATCHMENT

A roof drainage system is best analysed by dividing it into lengths of gutter each sloping down from a high point to an outlet with a downpipe. A long length of roof usually drains into several lengths of gutter separated by expansion joints that are also high points. The catchment area for a length of gutter is determined by multiplying the rafter length by the length of gutter (G) and adding a proportion of any vertical surface against which rain can be driven. A reasonable procedure is to add half the area of a very exposed vertical surface and smaller proportions for less extreme conditions (see Figure 2.1).

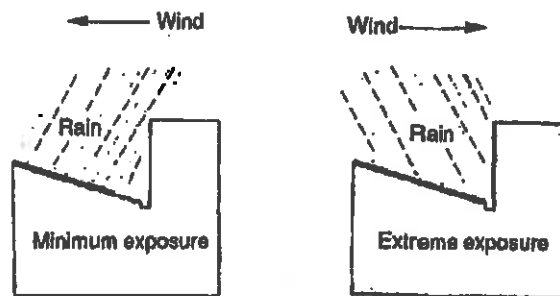
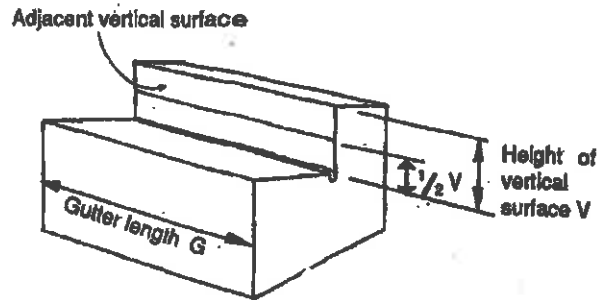

FIGURE 2.1 EFFECT OF VERTICAL SURFACE ON CATCHMENT

The length G of a gutter is measured as the distance from a high point in the gutter to the downpipe when the downpipe is at the end of the gutter and between high points when the downpipe is not at the end (see Figure 2.2).



FIGURE 2.2 MEASURING GUTTER LENGTH

3 EAVES GUTTER

The procedure for the design of eaves gutters is as follows:

3.1 Size

Space the downpipes suitably and calculate the catchment area per downpipe. For eaves gutters of permanent buildings determine the gutter discharge area by matching the catchment area against the 115 mm/hr intensity line in Figure 3.1. If the gutter discharge area obtained is more than what is available from a standard gutter after allowing for a 25 mm freeboard, either reduce the spacing of the downpipes and recalculate or proceed to specify a specially fabricated gutter. With rectangular fabricated gutters an additional allowance of 10 percent of area must be made in addition to the freeboard allowance.

The net cross-sectional area of each vertical downpipe, including the nozzle must be not less than 50 per cent of the gutter discharge area.

3.2 Slope

The fall of an eaves gutter must never be less than 1 in 500 but in areas where dust or debris is likely to build up between rain periods the slope must be as steep as 1 in 50.

3.3 Leaf guards and overflows

Leaf guards must be fitted to prevent the nozzle to the downpipe from becoming blocked wherever leaves or other debris are likely to collect in the gutter. If the eaves gutter has a fascia front higher than the rear lip, an overflow must be fitted at a level below that of the lowest point in the rear lip.

3.4 Proportion

The proportions of a rectangular eaves gutter are ideal when its width is twice the maximum depth of water flowing in it. Although a narrow deep gutter will provide a greater head of water over the outlet with a consequent improvement in the discharge capacity of the outlet, a shallower gutter is usually easier to maintain.

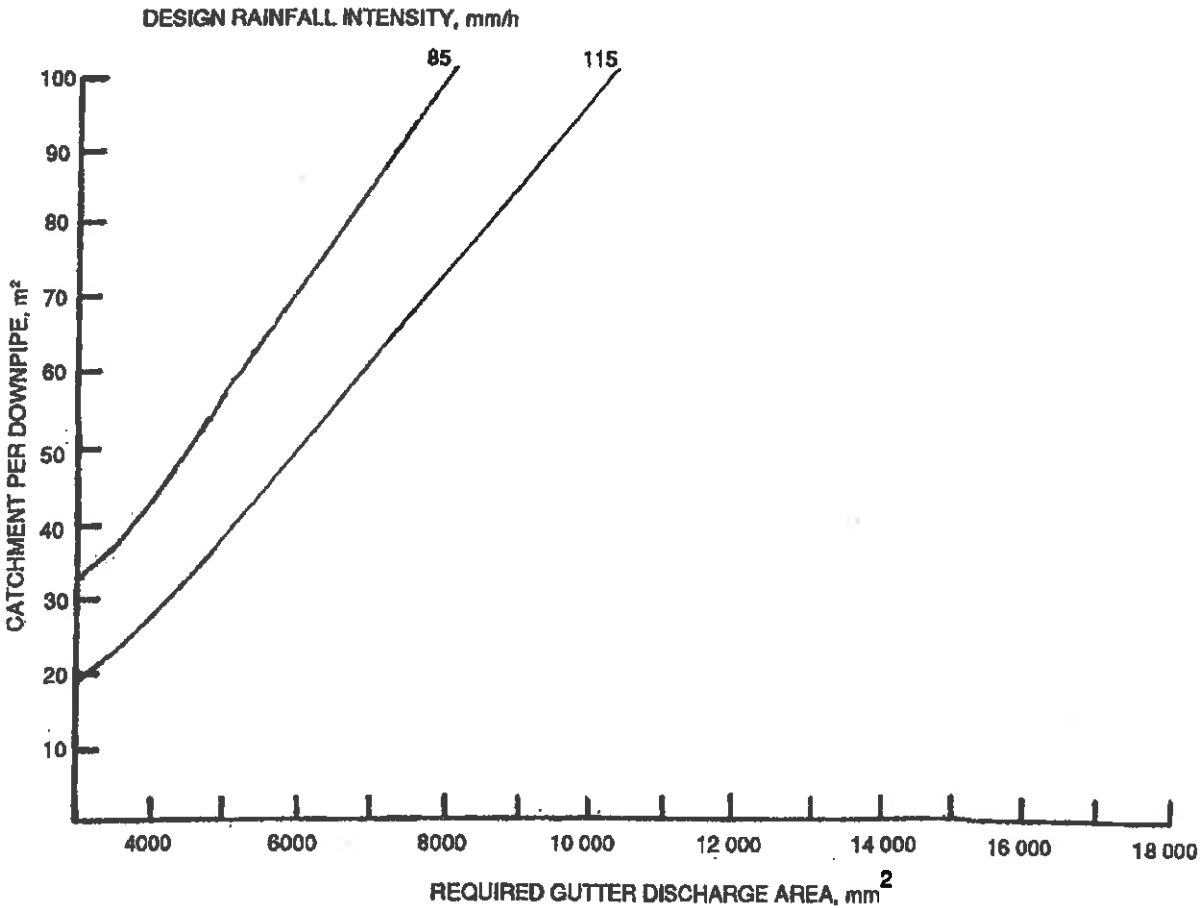

FIGURE 3.1 EAVES GUTTER SIZING

4 BOX GUTTERS

The procedure for the design of box gutters is as follows:

Ideally, box gutters must be straight, at least 300 mm wide, capable of supporting a workman, fixed at a slope of not less than 1 in 200, and provided with an overflow and adequate downpipe outlets not more than 18 m apart. The gutters must have sufficient slope to clear dust and debris and they might need leaf guards.

4.1 Size of gutter

Space the downpipes suitably and calculate the catchment area per downpipe. From Figure 4.1.1 using the calculated

catchment area and 150 mm/hr rain intensity, determine the design flow for the gutter and the downpipe. Select a width of not less than 300 mm for the box gutter. The required depth can then be read from Figure 4.1.2 by using the selected width and the design flow. The depth allows for a freeboard of 35 mm which will be necessary during cyclonic winds along with normal turbulence and ripples. The depth thus determined assumes that the gutter is laid to zero slope. To adjust for the slope, use the depth determined from Figure 4.1.2 in Figure 4.1.3 and read off the depth adjusted for slope against the appropriate slope line. The minimum depth must be 80 mm.

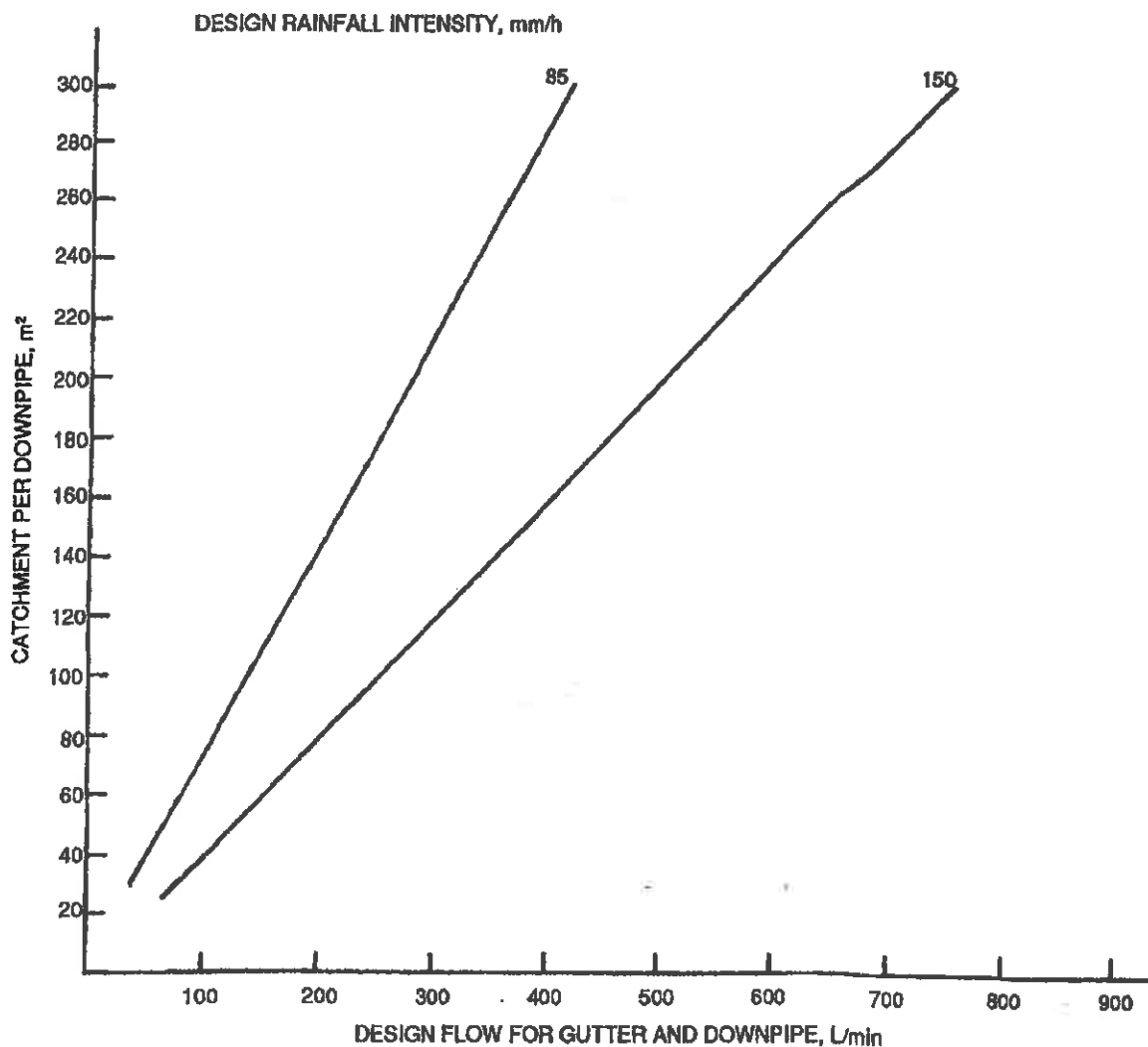
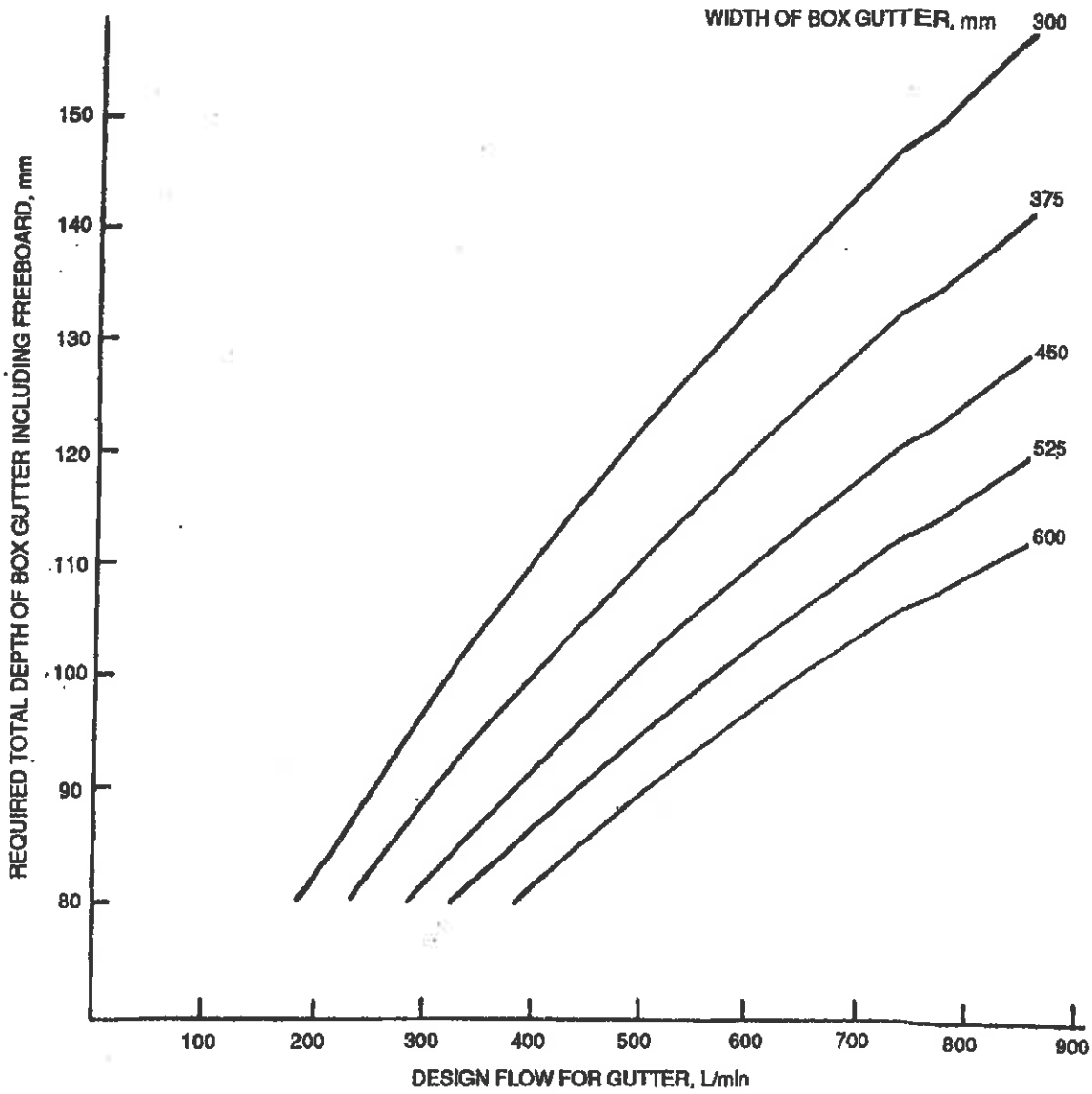

FIGURE 4.1.1 INTERNAL BOX GUTTER DESIGN FLOW



Notes:

- 1 Graph assumes zero slope. To take advantage of slope, see Fig. 4.1.3.
- 2 Graph assumes 35 mm freeboard.

FIGURE 4.1.2 REQUIRED DEPTH OF BOX GUTTER FOR DESIGN FLOW

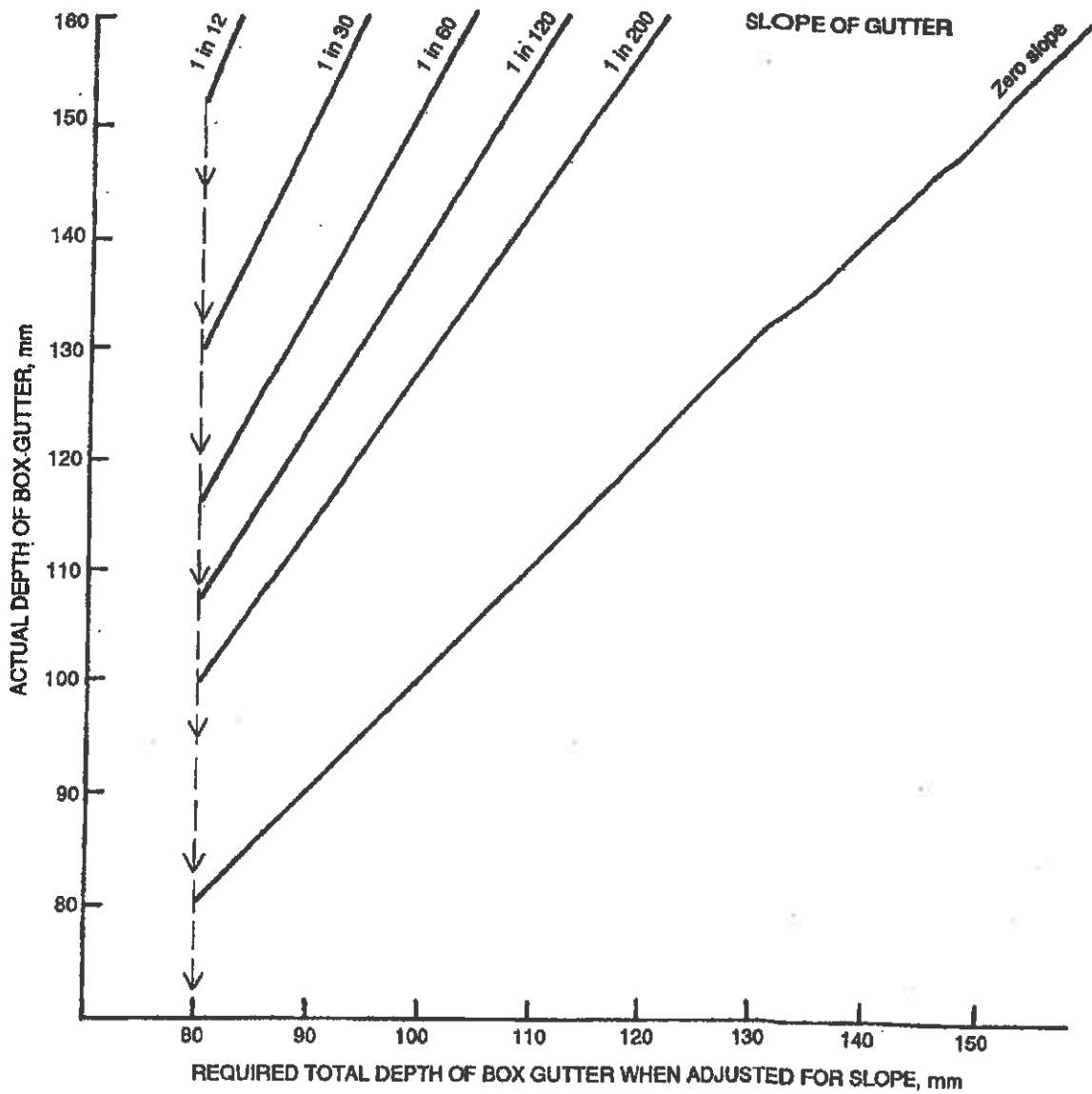

FIGURE 4.1.3 BOX GUTTER DEPTH - ADJUSTED FOR SLOPE

NF7.2 SIZING OF GUTTERS AND DOWNPIPES

4.2 Size of downpipe

The size of the downpipe can be determined from figure 4.2 by reading against the design flow and the actual depth of the gutter determined from using figure 4.1.3. The downpipes can be round or rectangular.

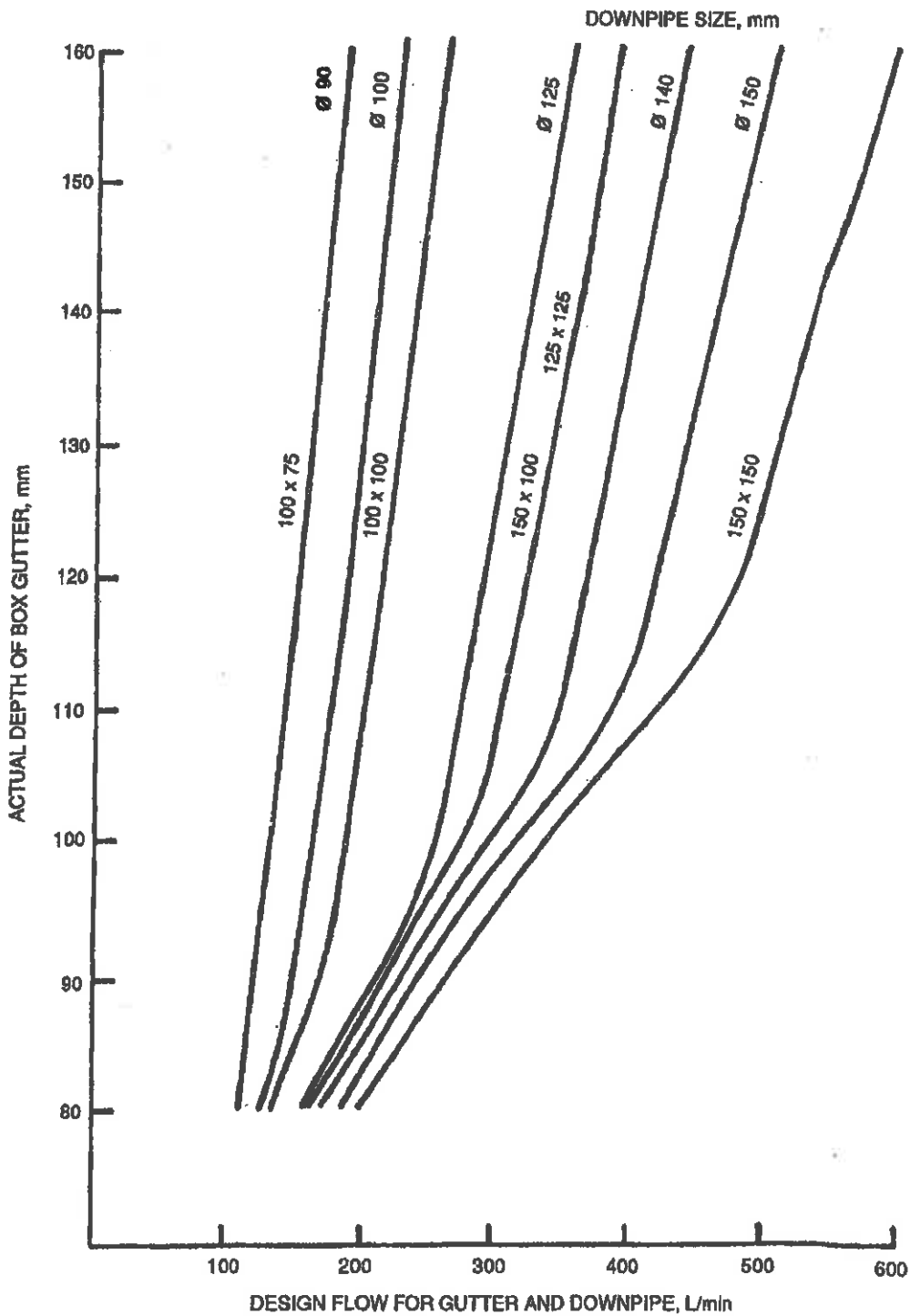

FIGURE 4.2 REQUIRED SIZE OF DOWNPIPE FOR BOX GUTTER
(RAINHEAD AND SUMP NOT CONSIDERED)

4.3 Overflow

A box gutter discharging directly into a downpipe must have an overflow outlet to allow for blockage and to provide for rainfall intensities greater than those used for design. To cope only with peaks in rainfall it is sufficient for the overflow outlet to have a cross sectional area equal to 15 percent of the total cross-sectional area of the gutter, that is an overflow area of $0.15 dw$ (see Figure 4.3.1).

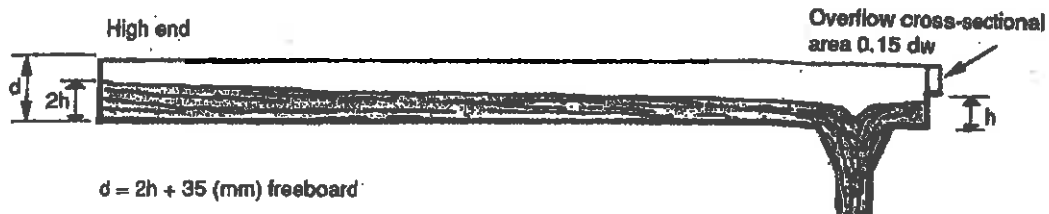

FIGURE 4.3.1 OVERFLOW OUTLET

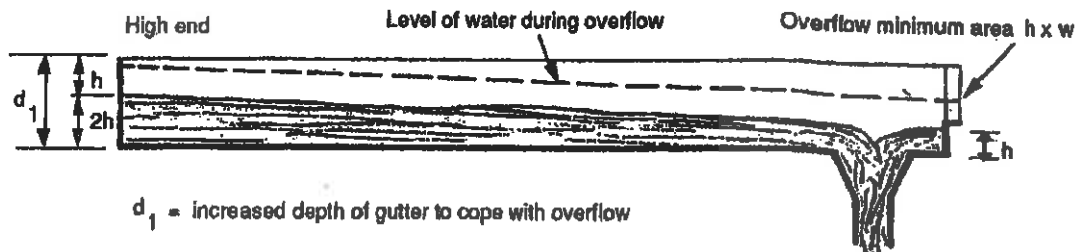

FIGURE 4.3.2 OVERFLOW WITH BLOCKED DOWNPIPE

But if the overflow is intended to cope with the effect of a total blockage of the downpipe during a peak period then the cross-sectional area of the overflow outlet must equal the cross-sectional area of the water flow at the outlet of the gutter ($h \times w$ for minimum fall). The overflow should be slightly above level h and if it is the same width as the gutter, the depth of the gutter will have to be further increased by an amount equal to h in order to accommodate the flow of water in a crisis (see Figure 4.3.2). The slope factor must not be taken into account when determining the new depth for the gutter and the amount of freeboard added to the increased gutter depth will depend on the risk the designer wishes to take regarding the possibilities of failure of the roof-drainage system during a peak period. Other methods of preventing overflow due to blocked downpipes are the provision of rainheads and sumps.

5 RAINHEADS AND SUMPS

5.1 Rainheads

The rainhead is a device used to increase the capacity of a downpipe at the end of a box gutter and to allow for overflow in case of a blocked downpipe. The discharge capacity of an outlet increases with the depth of water (head) over the outlet. The rainhead is located at the far end of a box gutter and consists of a sump and overflow arrangements. The sump increases the flow through the downpipe by providing an additional head of water. The overflow provides safety against water spilling into the building if the downpipe is blocked. The detailed design of rainheads is given in AS 2180.

5.2 Sumps

Where a sump is fitted to the sole of a gutter it provides a local reservoir and the additional head increases the flow through the downpipe. The detailed design of sumps is given in AS 2180.

6 DOWNPIPES

6.1 Location

Downpipes must be located externally, but where it is necessary to locate a downpipe internally the pipe must be accessible so that any blockage can be cleared. Access for cleaning must be provided at the base of all downpipes that are connected directly to a storm water drain. Downpipes are most efficient when located at the centre of a length of gutter.

6.2 Swirl

The performance of an outlet with the head of water more than 1/3 of its diameter will be reduced if swirl occurs at the outlet. This would generally happen only where rainheads or sumps are included in the system. Swirl can be eliminated if the centreline of the downpipe is kept no more than a distance equal to its diameter or the average of its cross-sectional dimensions, away from the nearest vertical side of the rainhead or the sump.

6.3 Gratings

Where a grating or strainer is fitted to a rain-water outlet the total area of the perforations in the grating must be at least 1.5 times the cross-sectional area of the outlet. Strainer gratings must project above the calculated level of flow at the outlet and must be cleared of accumulated debris regularly.

7 INCOMPATIBLE MATERIALS

Dissimilar metals must be separated by a non-conducting gasket or similar device to prevent electro-chemical corrosion. Water draining from copper components must not discharge onto non-copper components for the same reason. However, water can be safely drained from non-copper onto copper components. (The prevention of electro-chemical corrosion between metals will not necessarily prevent atmospheric corrosion of the individual metals).

8 EXPANSION JOINTS FOR GUTTERS

Metal gutters must be provided with expansion joints to prevent distortion and resulting damage and reduced flow. The maximum length between expansion joints is given in Table 8.

TABLE 8
Maximum Distance between gutter expansion joints

Material	Estimated exposed temperature range (°C)	Distance between 20 mm expansion joints (m)
Aluminium	45	18
Copper	55	21
Stainless Steel	40	30
Steel	50	33
Zinc	50	15

9 STORMWATER

9.1 Where a downpipe discharges into a storm water gully it must terminate below the gully grating, and where the connection is made directly to a stormwater pipe underground the internal diameter of the underground pipe must be greater than that of the downpipe. Underground stormwater pipes draining roof and paved catchments must be laid in straight lines at uniform gradients between sumps or collection pits. Large paved areas and roadways must slope towards drainage points with a minimum cross-fall of 1 in 60 for bitumen or concrete surfaces and 1 in 120 for concrete kerb channels.

9.2 Pipe sizes

Table 9.2 indicates the maximum total catchment area of roof and paving that can be drained by underground pipes laid at different gradients, of various diameters and running half full. Areas shown above the heavy line will have a flow velocity insufficient to flush out debris.

The Table is for a rainfall intensity of 115 mm/h. For other rainfall intensities, the horizontal area to be drained must be proportionally adjusted by multiplying the area by 115 and dividing by the required rainfall intensity. The proportionally adjusted area can be used in the Table to determine the pipe size.

Diameter of Pipe (mm)	Maximum horizontal projected areas (m ²) that can be drained at various gradients when the rainfall intensity is 115 mm/h			
	1 in 50	1 in 100	1 in 150	1 in 200
100	220	150	130	110
150	600	430	350	260
200	1300	950	780	650
250	2350	1850	1300	1130
300	3700	2800	2170	1910
375	6700	4700	3820	3130
450	8800	6950	5650	4600

NATIONAL
BUILDING
CODE
1990

PUBLIC BUILDINGS AND GROUP DWELLINGS (CLASS 2 TO 9)

SECTION **NG**

ANCILLARY PROVISIONS

**Performance Requirements
Deemed-to-Satisfy Provisions**

- NG1 Minor Structures and Components**
- NG2 Fireplaces, Chimneys and Flues**
- NG3 Atrium Construction**

CONTENTS

PERFORMANCE REQUIREMENTS

DEEMED-TO-SATISFY PROVISIONS

Part		Part	
NG1	Minor Structures and Components	NG1.6	Fences
NG1.1	Swimming pools	NG2	Fireplaces, Chimneys and Flues
NG1.2	Refrigerated chambers, strong rooms and vaults	NG2.1	General requirements
NG1.3	Parapets on flat roofs	NG2.2	Open fireplaces
NG1.4	Projections over public places	NG2.3	Incinerator rooms
NG1.5	Moveable awnings or sunshades over public places	NG3	Atrium Construction

PERFORMANCE REQUIREMENTS

OBJECTIVES AND REQUIRED PERFORMANCE

This Section contains more specific requirements for particular parts of buildings or structures.

Parts of buildings and structures must be so designed and constructed that the following objectives, in addition to those listed for Sections B, NC, ND, NE and NF where relevant, are fulfilled:

NGP1 Minor Structures and Components

NGP1.1 Swimming pools-

- (a) Suitable means for the disposal of waste and drainage must be provided to a *swimming pool*.
- (b) Access by unsupervised young children to *swimming pools* must be restricted.

NGP1.2 Refrigerated chambers, strong rooms and vaults-

Refrigerated or cooling chambers, strong rooms and vaults, or the like, which are capable of entry by a person must have adequate safety measures to facilitate escape and for alerting persons outside the chamber or vault in the event of an emergency.

NGP1.3 Safety at elevated places

Elevated places with regular access such as some flat roofs must have adequate protection to prevent anyone from falling.

NGP1.4 Use of the air space over public places

Any use of the air space over public places such as footpaths and roads must be limited to ensure that normal public use of such places is not obstructed.

NGP1.5 Aesthetics

Any minor structure such as fencing, awnings and such like must be suited to the general surroundings and the occupancy of the buildings and the neighbourhood.

NGP2 Fireplaces, Chimneys and Flues

Fireplaces, chimneys and flues must be adequately constructed or separated to prevent-

- (a) Ignition of nearby parts of the building; or
- (b) escape or discharge of smoke to the inside of the building or to adjacent *windows*, ventilation inlets, or the like.

NGP3 Atrium Construction

The construction of an *atrium* must not unduly increase the danger to occupants from fire or smoke.

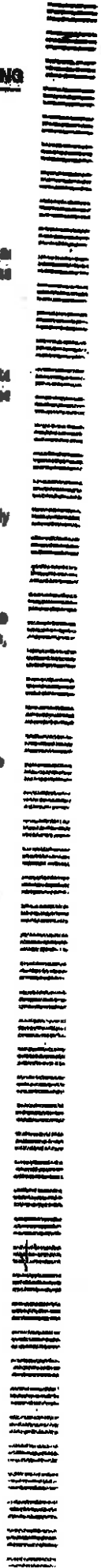

DEEMED-TO-SATISFY PROVISIONS

MINOR STRUCTURES AND COMPONENTS

NG1.1 Swimming pools

- (a) **Drainage:** A *swimming pool* must have suitable means of drainage.
- (b) **Safety fencing:** A *swimming pool* with a depth of water more than 300 mm must have suitable barriers or safety fencing in accordance with AS 2818 and AS 1926 to restrict access by young children to the immediate pool surrounds if the *swimming pool* is associated with a Class 2 or 3 building or is a public pool.

NG1.2 Refrigerated chambers, strong rooms and vaults

- (a) A refrigerated or cooling chamber which is of sufficient size for a person to enter must-
 - (i) have a door which is in an opening with a clear width of not less than 600 mm and a clear height of not less than 1.5 m; and
 - (ii) at all times, be able to be opened from inside without a key.
- (b) A strong room or a vault in a building must have-
 - (i) internal lighting controllable only from within the room; and
 - (ii) a pilot light located outside the room but controllable only by the switch for the internal lighting.
- (c) A refrigerated or cooling chamber, strong room or vault must have a suitable alarm device located outside but controllable only from within the chamber, room or vault.

NG1.3 Parapets on flat roofs

Where a flat roof or other elevated place has regular access a parapet or balustrade of not less than 1 m height above the surface of the roof or elevated place must be provided. The width of any opening in the parapet or balustrade must not exceed 100 mm.

NG1.4 Projections over public places

Buildings must not project beyond the allotment boundary. Architectural features such as eaves, cornices, clocks, lamps, ventilating equipment, trade signs, hoardings, flag poles, bay or oriel windows and such like, as well as a platform or balcony to provide additional means of egress from an existing building, may however project over public footpaths or roads with the following minimum clearances-

- (a) 3300 mm above existing or intended finished level of footpaths; and
- (b) the outer extremity of the feature must be set back 300 mm from the existing or intended kerb.

Any drainage from such architectural features (including drainage from airconditioning and other ventilating equipment) must be suitably taken down to a drain with downpipes which must also satisfy the *required* clearances.

NG1.5 Moveable Awnings or sunshades over public places

Any moveable awnings or sunshades must be firmly fixed so that they do not create any danger, obstruction or inconvenience to pedestrians. They must provide the following minimum clearances if they project over public places:-

- (a) 2300 mm above the finished levels of the footpath; and
- (b) their outer extremity must be set back 300 mm from the kerb.

NG1.6 Fences

Any fencing or free-standing wall must be suited to the occupancy of the building within. It must not detract from the general aesthetic appearance of the surroundings. If any barbed wire or other such is used it must be at a height of not less than 2 m above the finished level of any existing or intended adjacent footpath.

FIREPLACES, CHIMNEYS AND FLUES

NG2.1 General requirements

A chimney or flue must be constructed-

- (a) to withstand the temperatures likely to be generated by the appliance to which it is connected;
- (b) so that the temperature of the exposed faces will not exceed a level that would cause damage to nearby parts of the building;
- (c) so that hot products of combustion will not-
 - (i) escape through the walls of the chimney or flue; or
 - (ii) discharge in a position that will cause fire to spread to nearby *combustible* materials or allow smoke to penetrate through nearby windows, ventilation inlets, or the like;
- (d) in such a manner as to prevent rainwater penetrating to any part of the interior of the building;
- (e) such that its termination is not less than:
 - (i) 800 mm above any point of penetration or contact with the roof; and
 - (ii) 900 mm above any opening or openable part in any building, within 3 m horizontal distance of the chimney or flue; and
- (f) so that it is accessible for cleaning.

(iv) *combustible* material situated below the hearth (but not below that part *required* to extend beyond the fireplace opening or the limits of the fireplace) is not less than 155 mm from the upper surface of the hearth;

(b) walls forming the sides and back of the fireplace up to not less than 300 mm above the underside of the arch or lintel which-

(i) are constructed in 2 separate leaves of solid masonry not less than 180 mm thick, excluding any cavity; and

(ii) do not consist of concrete block masonry in the construction of the inner leaf;

(c) walls of the chimney above the level referred to in (b)-

(i) constructed of masonry units with a net volume, excluding cored and similar holes, not less than 75% of their gross volume, measured on the overall rectangular shape of the units, and with an actual thickness of not less than 90 mm; and

(ii) lined internally to a thickness of not less than 12 mm with rendering consisting of 1 part cement, 3 parts lime, and 10 parts sand by volume, or other suitable material; and

(d) suitable damp-proof courses or flashings to maintain weatherproofing.

NG2.2 Open fireplaces

An open fireplace, or solid-fuel burning appliance in which the fuel-burning compartment is not enclosed, satisfies NG2.1 if it has-

- (a) a hearth constructed of stone, concrete, masonry or similar *non-combustible* material so that-
 - (i) it extends not less than 300 mm beyond the front of the fireplace opening and not less than 150 mm beyond each side of that opening;
 - (ii) it extends beyond the limits of the fireplace or appliance not less than 300 mm if the fireplace or appliance is free-standing from any wall of the room;
 - (iii) its upper surface does not slope away from the grate or appliance; and

NG2.3 Incinerator rooms

- (a) If an incinerator is installed in a building any hopper giving access to a charging chute must be-
 - (i) *non-combustible*;
 - (ii) gastight when closed;
 - (iii) designed to automatically return to the closed position after use;
 - (iv) not attached to a chute that connects directly to a flue unless the hopper is located in the open air; and
 - (v) not located in a *required exit*.
- (b) If an incinerator is in a separate room, that room must be separated from other parts of the building by construction with a FRL of not less than 80/80/60.

ATRIUM CONSTRUCTION

NG3.1 The design of an *atrium* along with the attendant life safety provisions such as fire prevention, fire fighting, smoke exhaust systems, etc. must fulfil up-to-date and relevant fire engineering principles and practices.

**NATIONAL
BUILDING
CODE
1990**

PUBLIC BUILDINGS

SECTION NH

SPECIAL USE BUILDINGS

**Performance Requirements
Deemed-to-Satisfy Provisions**

NH1 Theatres, Stages and Public Halls

CONTENTS

OBJECTIVES

PERFORMANCE REQUIREMENTS

Part

NH1 Theatres, Stages and Public Halls

NH1.1 Application of Part

NH1.2 Separation and smoke control

NH1.3 Proscenium wall construction

Part

NH1.4 Seating area

NH1.5 Exits from theatre stages

NH1.6 Access to platforms and lofts

Specifications

Specification NH1.2

Construction of Theatres with Proscenium Walls

PERFORMANCE REQUIREMENTS

OBJECTIVES AND REQUIRED PERFORMANCE

This Section contains more specific requirements for particular special use buildings.

Special use buildings must be so designed and constructed that the following objectives, in addition to those listed for Sections B, NC, ND, NE, and NF where relevant, are fulfilled.

NHP1 Theatres, Stages and Public Halls

The audience seating area and egress routes of a Class 9b building used as a theatre, public hall, or the like, must be protected against fire and smoke from any fire occurring on stage, in backstage areas or in a rigging loft.

DEEMED-TO-SATISFY PROVISIONS

THEATRES, STAGES AND PUBLIC HALLS

NH1.1 Application of Part

This Part applies to every enclosed Class 9b building which-

- (a) has a *stage* and any *backstage* area with a total *floor area* of more than 200 m²; or
- (b) has a *stage* with an associated rigging loft.

NH1.2 Separation and smoke control

The design of smoke control systems for theatres and public halls must fulfill up-to-date fire engineering principles and practices.

A theatre, public hall or the like must-

- (a) have a smoke control system in accordance with AS 1668.1 where relevant; or
- (b) have the *stage*, *backstage* area and accessible under-stage area, separated from the audience by a proscenium wall and have a mechanical exhaust system, both in accordance with Specification NH1.2.

NH1.3 Proscenium wall construction

A proscenium wall and mechanical exhaust system required by NH1.2(b) must comply with Specification NH1.2.

NH1.4 Seating area

In a seating area in a Class 9b building or part of a building-

- (a) the slope of the floor surface must not exceed 1 : 8, or the floor must be stepped so that-
 - (i) the *pitch* does not exceed 30°;
 - (ii) it has a riser height not more than 600 mm; and

(iii) the height of any opening in the riser is not more than 100 mm;

(b) if an aisle divides the stepped floor and the difference in level between any 2 consecutive steps-

(i) exceeds 230 mm but not 400 mm - an intermediate step must be provided in the aisle;

(ii) exceeds 400 mm - 2 equally spaced steps must be provided in the aisle; and

(iii) the going of intermediate steps must be not less than 270 mm and such as to provide as nearly as practicable equal treads throughout the length of the aisle; and

(c) the clearance between rows of fixed seats used for viewing performing arts, sport or recreational activities must be not less than-

(i) 300 mm if the distance to an aisle is not more than 3.5 m; or

(ii) 500 mm if the distance to an aisle is more than 3.5 m.

NH1.5 Exits from theatre stages

(a) The path of travel to an *exit* from a *stage* or performing area must not pass through the proscenium wall if the stage area is separated from the audience area with a proscenium wall.

(b) *Required exits* from *backstage* and under-stage areas must be independent of those provided for the audience area.

NH1.6 Access to platforms and lofts

A *stairway* that provides access to a service platform, rigging loft, or the like, must comply with AS 1657.